



NexAIoT Co., Ltd.

IoT Automation Solutions Business Group

Industrial Fanless Computer

NISE 3910 Series

User Manual

CONTENTS

Preface

Copyright	iv
Disclaimer	iv
Acknowledgements	iv
Regulatory Compliance Statements.....	iv
Declaration of Conformity.....	iv
RoHS Compliance	v
Warranty and RMA	vi
Installation Recommendations.....	vii
Safety Information	viii
Safety Precautions.....	ix
Technical Support and Assistance.....	x
Conventions Used in this Manual.....	x
Global Service Contact Information.....	xi
Package Contents.....	xiii
Ordering Information.....	xix

Chapter 1: Product Introduction

NISE 3910E	1
NISE 3910E Key Features	1
NISE 3910E Hardware Specifications.....	2
NISE 3910E Parts	4
NISE 3910E Mechanical Dimensions.....	6
NISE 3910E16/E2/P2/P2E.....	7
Key Features.....	7
NISE 3910E16/E2/P2/P2E Hardware Specifications.....	8

NISE 3910E16/E2/P2/P2E Parts	10
NISE 3910E16/E2/P2/P2E Mechanical Dimensions	12
NISE 3910R.....	13
Key Features.....	13
NISE 3910R Hardware Specifications.....	14
NISE 3910R Parts.....	16
NISE 3910R Mechanical Dimensions	18

Chapter 2: Jumpers and Connectors

Before You Begin	23
Precautions	23
Jumper Settings	24
Locations of the Jumpers and Connectors for the NISE 3910 Series.....	25
Top View	25
Bottom View	26
Jumpers and DIP Switch Settings.....	27
COM3 Power Output Select.....	27
AT/ATX Power Select	27
PCIe Select	28
Clear CMOS	28
Connector Pin Definitions	29
External I/O Interfaces - Front Panel	29
USB 2.0 Ports.....	29
USB 2.0 Ports.....	29
DisplayPort.....	30
LED Indicators.....	30
Power Button.....	33

External I/O Interfaces - Rear Panel.....	34
9V - 30V DC Power Input.....	34
External I/O Interfaces - Rear Panel.....	34
DC Power Input	34
Remote Power On/Off.....	34
LAN Port 1	35
LAN Port 2 + USB 3.1 Gen1	36
LAN Port 3 + USB 3.1 Gen1	37
LAN Port 4 + USB 3.1 Gen1	38
VGA + HDMI	39
Internal Connectors - Top Side.....	40
Audio Connectors.....	40
RTC Battery Connector.....	41
M.2 Key B	42
M.2 Key M.....	44
Mini PCIe Connector.....	46
USB Dongle Connector	47
COM Port 1	47
COM Port 2	48
COM Port 3	48
COM Port 4	49
COM4_RS422 (Optional).....	49
Fan Connectors.....	50
BIOS FW Connector	50
GPIO Connector.....	51
LED Connector.....	51
SMBUS Connector	52
Power Module Connector	53
SMBUS Connector	54
Internal Connectors - Bottom Side.....	55
SIM Card Slot.....	55
SATA Power Connector	55

PCIe X16 Slot.....	56
SATA Connectors	58

Chapter 3: System Setup

Removing the Top Cover	51
Removing the Bottom Cover.....	53
Installing a CPU.....	54
Installing a SO-DIMM Memory Module	57
Installing a Mini-PCIe Module.....	58
Installing a SIM Card	60
Installing an M.2 Module (External).....	61
Installing an M.2 Module (Internal).....	63
Installing an Internal SATA Storage Drive (NISE 3910E/E16/E2/P2/P2E) ..	64
Installing an Internal SATA Storage Drive (NISE 3910R)	66
Wallmount Brackets.....	67

Chapter 4: BIOS Setup

About BIOS Setup.....	70
When to Configure the BIOS.....	70
Default Configuration	71
Entering Setup.....	71
Legends.....	71
BIOS Setup Utility.....	73
Main	73
Advanced	74
Chipset.....	81
Security	85
Boot.....	86
Save & Exit	87
MEBx.....	88

PREFACE

Copyright

This publication, including all photographs, illustrations and software, is protected under international copyright laws, with all rights reserved. No part of this manual may be reproduced, copied, translated or transmitted in any form or by any means without the prior written consent from NexAloT Co., Ltd.

Disclaimer

The information in this document is subject to change without prior notice and does not represent commitment from NexAloT Co., Ltd. However, users may update their knowledge of any product in use by constantly checking its manual posted on our website: <http://www.nexaiot.com>. NexAloT shall not be liable for direct, indirect, special, incidental, or consequential damages arising out of the use of any product, nor for any infringements upon the rights of third parties, which may result from such use. Any implied warranties of merchantability or fitness for any particular purpose is also disclaimed.

Acknowledgements

NISE 3910 series products are the trademarks of NexAloT Co., Ltd. All other product names mentioned herein are registered trademarks of their respective owners.

Regulatory Compliance Statements

This section provides the FCC compliance statement for Class A devices and describes how to keep the system CE compliant.

Declaration of Conformity

FCC

This equipment has been tested and verified to comply with the limits for a Class A digital device, pursuant to Part 15 of FCC Rules. These limits are designed to provide reasonable protection against harmful interference when the equipment is operated in a commercial environment. This equipment generates, uses, and can radiate radio frequency energy and, if not installed and used in accordance with the instructions, may cause harmful interference to radio communications. Operation of this equipment in a residential area (domestic environment) is likely to cause harmful interference, in which case the user will be required to correct the interference (take adequate measures) at their own expense.

CE

The product(s) described in this manual complies with all applicable European Union (CE) directives if it has a CE marking. For computer systems to remain CE compliant, only CE-compliant parts may be used. Maintaining CE compliance also requires proper cable and cabling techniques.

RoHS Compliance



NexAloT RoHS Environmental Policy and Status Update

NexAloT is a global citizen for building the digital infrastructure. We are committed to providing green products and services, which are compliant with European Union RoHS (Restriction on Use of Hazardous Substance in Electronic Equipment) directive 2011/65/EU, to be your trusted green partner and to protect our environment.

RoHS restricts the use of Lead (Pb) < 0.1% or 1,000ppm, Mercury (Hg) < 0.1% or 1,000ppm, Cadmium (Cd) < 0.01% or 100ppm, Hexavalent Chromium (Cr6+) < 0.1% or 1,000ppm, Polybrominated biphenyls (PBB) < 0.1% or 1,000ppm, and Polybrominated diphenyl Ethers (PBDE) < 0.1% or 1,000ppm.

In order to meet the RoHS compliant directives, NexAloT has established an engineering and manufacturing task force to implement the introduction of green products. The task force will ensure that we follow the standard NexAloT development procedure and that all the new RoHS components and new manufacturing processes maintain the highest industry quality levels for which NexAloT are renowned.

The model selection criteria will be based on market demand. Vendors and suppliers will ensure that all designed components will be RoHS compliant.

How to recognize NexAloT RoHS Products?

For existing products where there are non-RoHS and RoHS versions, the suffix "(LF)" will be added to the compliant product name.

All new product models launched after January 2013 will be RoHS compliant. They will use the usual NexAloT naming convention.

Warranty and RMA

NexAloT Warranty Period

NexAloT manufactures products that are new or equivalent to new in accordance with industry standard. NexAloT warrants that products will be free from defect in material and workmanship for 2 years, beginning on the date of invoice by NexAloT.

NexAloT Return Merchandise Authorization (RMA)

- Customers shall enclose the “NexAloT RMA Service Form” with the returned packages.
- Customers must collect all the information about the problems encountered and note anything abnormal or, print out any on-screen messages, and describe the problems on the “NexAloT RMA Service Form” for the RMA number apply process.
- Customers can send back the faulty products with or without accessories (manuals, cable, etc.) and any components from the card, such as CPU and RAM. If the components were suspected as part of the problems, please note clearly which components are included. Otherwise, NexAloT is not responsible for the devices/parts.
- Customers are responsible for the safe packaging of defective products, making sure it is durable enough to be resistant against further damage and deterioration during transportation. In case of damages occurred during transportation, the repair is treated as “Out of Warranty.”
- Any products returned by NexAloT to other locations besides the customers’ site will bear an extra charge and will be billed to the customer.

Repair Service Charges for Out-of-Warranty Products

NexAloT will charge for out-of-warranty products in two categories, one is basic diagnostic fee and another is component (product) fee.

System Level

- Component fee: NexAloT will only charge for main components such as SMD chip, BGA chip, etc. Passive components will be repaired for free, ex: resistor, capacitor.
- Items will be replaced with NexAloT products if the original one cannot be repaired. Ex: motherboard, power supply, etc.
- Replace with 3rd party products if needed.
- If RMA goods can not be repaired, NexAloT will return it to the customer without any charge.

Board Level

- Component fee: NexAloT will only charge for main components, such as SMD chip, BGA chip, etc. Passive components will be repaired for free, ex: resistors, capacitors.
- If RMA goods can not be repaired, NexAloT will return it to the customer without any charge.

Warnings

Read and adhere to all warnings, cautions, and notices in this guide and the documentation supplied with the chassis, power supply, and accessory modules. If the instructions for the chassis and power supply are inconsistent with these instructions or the instructions for accessory modules, contact the supplier to find out how you can ensure that your computer meets safety and regulatory requirements.

Cautions

Electrostatic discharge (ESD) can damage system components. Do the described procedures only at an ESD workstation. If no such station is available, you can provide some ESD protection by wearing an antistatic wrist strap and attaching it to a metal part of the computer chassis.

Installation Recommendations

Ensure you have a stable, clean working environment. Dust and dirt can get into components and cause a malfunction. Use containers to keep small components separated.

Adequate lighting and proper tools can prevent you from accidentally damaging the internal components. Most of the procedures that follow require only a few simple tools, including the following:

- A Philips screwdriver
- A flat-tipped screwdriver
- A grounding strap
- An anti-static pad

Using your fingers can disconnect most of the connections. It is recommended that you do not use needle-nose pliers to disconnect connections as these can damage the soft metal or plastic parts of the connectors.

Field wiring shall be conducted by skilled persons

- Insert the positive and negative wires into the V+ and V- contacts on the terminal block connector.
- Tighten the wire-clamps screws to prevent the DC wires coming loose.

Take into consideration the following guidelines before wiring the device

- The Input connector is suitable for 30-12 AWG (min.10A). Torque value 5 lb-in.
- Please choose Copper wire.

Safety Information

Before installing and using the device, note the following precautions:

- Read all instructions carefully.
- Do not place the unit on an unstable surface, cart, or stand.
- Follow all warnings and cautions in this manual.
- When replacing parts, ensure that your service technician uses parts specified by the manufacturer.
- Avoid using the system near water, in direct sunlight, or near a heating device.
- The load of the system unit does not solely rely for support from the rackmounts located on the sides. Firm support from the bottom is highly necessary in order to provide balance stability.
- The computer is provided with a battery-powered real-time clock circuit. There is a danger of explosion if battery is incorrectly replaced. Replace only with the same or equivalent type recommended by the manufacturer. Discard used batteries according to the manufacturer's instructions.



- Danger of explosion if battery is incorrectly replaced. Replace with the same or equivalent type recommended by the manufacturer. Discard used batteries according to the manufacturer's instructions.
- Before equipment installation begins, ensure that a skilled personnel has attached an appropriate power cable supplied.
- Risk of explosion if the battery is replaced by an incorrect type. Dispose of used batteries according to the instructions.

Safety Precautions

1. Read these safety instructions carefully.
2. Keep this User Manual for later reference.
3. Disconnect this equipment from any AC outlet before cleaning. Use a damp cloth. Do not use liquid or spray detergents for cleaning.
4. For plug-in equipment, the power outlet socket must be located near the equipment and must be easily accessible.
5. Keep this equipment away from humidity.
6. Put this equipment on a stable surface during installation. Dropping it or letting it fall may cause damage.
7. The openings on the enclosure are for air convection to protect the equipment from overheating. **DO NOT COVER THE OPENINGS.**
8. Make sure the voltage of the power source is correct before connecting the equipment to the power outlet.
9. Place the power cord in a way so that people will not step on it. Do not place anything on top of the power cord. Use a power cord that has been approved for use with the product and that it matches the voltage and current marked on the product's electrical range label. The voltage and current rating of the cord must be greater than the voltage and current rating marked on the product.
10. All cautions and warnings on the equipment should be noted.
11. If the equipment is not used for a long time, disconnect it from the power source to avoid damage by transient overvoltage.
12. Never pour any liquid into an opening. This may cause fire or electrical shock.
13. Never open the equipment. For safety reasons, the equipment should be opened only by qualified service personnel.
14. If one of the following situations arises, get the equipment checked by service personnel:
 - a. The power cord or plug is damaged.
 - b. Liquid has penetrated into the equipment.
 - c. The equipment has been exposed to moisture.
 - d. The equipment does not work well, or you cannot get it to work according to the user's manual.
 - e. The equipment has been dropped and damaged.
 - f. The equipment has obvious signs of breakage.
15. Do not place heavy objects on the equipment.
16. The equipment is intended to be supplied by DC mains, input voltage tolerance should be within 9-30Vdc and without PE connection.
17. **CAUTION:** DANGER OF EXPLOSION IF BATTERY IS INCORRECTLY REPLACED. REPLACE ONLY WITH THE SAME OR EQUIVALENT TYPE RECOMMENDED BY THE MANUFACTURER. DISCARD USED BATTERIES ACCORDING TO THE MANUFACTURER'S INSTRUCTIONS.
18. Direct contact to metal enclosure should be less than 1 second time.

Technical Support and Assistance

1. For the most updated information of NexAloT products, visit NexAloT's website at www.nexaiot.com.
2. For technical issues that require contacting our technical support team or sales representative, please have the following information ready before calling:
 - Product name and serial number
 - Detailed information of the peripheral devices
 - Detailed information of the installed software (operating system, version, application software, etc.)
 - A complete description of the problem
 - The exact wordings of the error messages

Warning!

1. Handling the unit: carry the unit with both hands and handle it with care.
2. Maintenance: to keep the unit clean, use only approved cleaning products or clean with a dry cloth.
3. CompactFlash: Turn off the unit's power before inserting or removing a CompactFlash storage card.

Conventions Used in this Manual



Warning:

Information about certain situations, which if not observed, can cause personal injury. This will prevent injury to yourself when performing a task.



Caution:

Information to avoid damaging components or losing data.



Note:

Provides additional information to complete a task easily.



Safety Warning: This equipment is intended for installation in a Restricted Access Location only.

Global Service Contact Information

Headquarters

NEXCOM International Co., Ltd.

9F, No. 920, Zhongzheng Rd.,
Zhonghe District, New Taipei City, 23586,
Taiwan, R.O.C.
Tel: +886-2-8226-7786
Fax: +886-2-8226-7782
www.nexcom.com

Asia

Taiwan

NexAIoT Headquarters

Industry 4.0 and Cloud Services

12F, No.922, Zhongzheng Rd.,
Zhonghe District, New Taipei City,
23586, Taiwan, R.O.C.
Tel: +886-2-8226-7796
Fax: +886-2-8226-7926
Email: sales@nexaiot.com
www.nexaiot.com

NexAIoT Co., Ltd.

Taichung Office

16F, No.250, Sec.2, Chongde Rd.,
Beitun District,
Taichung City, 406, Taiwan, R.O.C.
Tel: +886-4-2249-1179
Fax: +886-4-2249-1172
Email: jacobhuang@nexaiot.com
www.nexaiot.com

NexCOBOT Taiwan Co., Ltd.

13F, No.916, Zhongzheng Rd.,
Zhonghe District,
New Taipei City, 23586, Taiwan, R.O.C.
Tel: +886-2-8226-7786
Fax: +886-2-8226-7926
Email: jennyshern@nexcobot.com
www.nexcobot.com

GreenBase Technology Corp.

13F, No.922, Zhongzheng Rd.,
Zhonghe District,
New Taipei City, 23586, Taiwan, R.O.C.
Tel: +886-2-8226-7786
Fax: +886-2-8226-7900
Email: vivianlin@nexcom.com.tw
www.nexcom.com.tw

DivioTec Inc.

19F-1A, No.97, Sec.4, ChongXin Rd.,
Sanhong District,
New Taipei City, 24161, Taiwan, R.O.C.
Tel: +886-2-8976-3077
Email: sales@diviotec.com
www.diviotec.com

AIoT Cloud Corp.

13F, No.922, Zhongzheng Rd.,
Zhonghe District,
New Taipei City, 23586, Taiwan, R.O.C.
Tel: +886-2-8226-7786
Fax: +886-2-8226-7782
Email: alantsai@aiotcloud.net
www.aiotcloud.dev

EMBUX TECHNOLOGY CO., LTD.

13F, No.916, Zhongzheng Rd.,
Zhonghe District,
New Taipei City, 23586, Taiwan, R.O.C.
Tel: +886-2-8226-7786
Fax: +886-2-8226-7782
Email: info@embux.com
www.embux.com

TMR TECHNOLOGIES CO., LTD.

13F, No.916, Zhongzheng Rd.,
Zhonghe District,
New Taipei City, 23586, Taiwan, R.O.C.
Tel: +886-2-8226-7786
Fax: +886-2-8226-7782
Email: services@tmrtek.com
www.tmrtek.com

China NEXSEC Incorporated

201, Floor 2, Unit 2, Building 15, Yard 3,
Gaolizhang Road, Haidian District,
Beijing, 100094, China
Tel: +86-10-5704-2680
Fax: +86-10-5704-2681
Email: marketing@nexsec.cn
www.nexsec.cn

NEXCOM Shanghai

Room 406-407, Building C, No 154, Lane 953,
Jianchuan Road, Minhang District,
Shanghai, 201108, China
Tel: +86-21-5278-5868
Fax: +86-21-3251-6358
Email: sales@nexcom.cn
www.nexcom.cn

NEXCOM Surveillance Technology Corp.

Floor 8, Building B3, Xiufeng Industrial Zone,
GanKeng Community, Buji Street,
LongGang District,
ShenZhen, 518112, China
Tel: +86-755-8364-7768
Fax: +86-755-8364-7738
Email: steveyang@nexcom.com.tw
www.nexcom.cn

NEXGOL Chongqing

1st Building No.999,
Star Boulevard, Yongchuan Dist,
Chongqing City, 402160, China
Tel: +86-23-4960-9080
Fax: +86-23-4966-5855
Email: sales@nexgol.com.cn
www.nexcom.cn

Beijing NexGemo Technology Co.,Ltd.

Room 205, No.1, Fazhan Rd.,
Beijing International Information Industry Base,
Changping District,
Beijing, 102206, China
Tel: +86-10-8072-2025
Fax: +86-10-8072-2022
Email: sales@nexgemo.cn
www.nexgemo.com

Japan

NEXCOM Japan

9F, Tamachi Hara Bldg.,
4-11-5, Shiba Minato-ku,
Tokyo, 108-0014, Japan
Tel: +81-3-5419-7830
Fax: +81-3-5419-7832
Email: sales@nexcom-jp.com
www.nexcom-jp.com

America USA NEXCOM USA

46665 Fremont Blvd.,
Fremont CA 94538, USA
Tel: +1-510-656-2248
Fax: +1-510-656-2158
Email: sales@nexcom.com
www.nexcomusa.com

Package Contents

Before continuing, verify that the NISE 3910 series package that you received is complete. Your package should have all the items listed in the following tables.

	Item	Part Number	Description	Qty
NISE 3910E	1	5060900292X00	WALL MOUNT BRACKET FOR NISE3600 VER:A CHYUAN-JYH	2
	2	50311F0317X00	ROUND HEAD SCREW LONG FEI:T30 P6x 10 ISO/SW13x1 with Nylok	8
	3	60233AT108X00	7P+15P SATA CABLE ST:MD-6101108	1
	4	5060600171X00	(H)2.5 HDD MYLAR E-LIN	1
	5	4NCPM00302X00	(T)TERMINAL BLOCKS 3P PHOENIX CONTACT:1777992	1
	6	4NCPF00310X00	TERMINAL BLOCKS 3P PHOENIX CONTACT:1803581	1
	7	5061600245X00	WASHER KANGYANG:TW-320-01	12
	8	5061711760X00	MINI PCI-E BRACKET FOR NISE106 SERIES VER:A ASDA	1
	9	5044440181X00	CERAMIC THERMAL PAD FOR NDiSP2210 T.G.:XL-25	2
	10	50311P0001X00	PRICE FOR PLASTIC SCREW	1
	11	50322P0002X00	PLASTIC NUT GIN LIAN:M6HW	1
	12	50311P0020X00	F HEAD SCREW KANG YANG:M3-6F(B)	4
	13	50311F0330X00	ROUND HEAD SCREW LONG FEI:P2x3 ISO+NYLON	2
	14	50311F0295X00	FLAT HEAD SCREW LONG FEI:F2x4 NYLOK NIGP	1
	15	50344C0379X00	COPPER POST FOR NISE53 SERIES VER:A LONG FEI	1
	16	50311F0396X00	I HEAD SCREW LONG FEI:I3x3 ISO+NYLOK BLACK	1
	17	50311F0213X00	FLAT HEAD SCREW LONG FEI:F3x4ISO+NYLOK NIGP	4
	18	50311F0144X00	I HEAD SCREW LONG FEI:	2
	19	5050300264X00	HEAT SINK Shyung Shuhm:SH20200618-1	1
	20	5060200111X00	THERMAL PAD E-LIN	1
	21	5060200685X00	THERMAL PAD T-GLOBAL	1

NISE 3910E2	Item	Part Number	Description	Qty
	1	5060900292X00	WALL MOUNT BRACKET FOR NISE3600 VER:A CHYUAN-JYH	2
	2	50311F0317X00	ROUND HEAD SCREW LONG FEI:T30 P6x 10 ISO/SW13x1 with Nylok	8
	3	60233AT108X00	7P+15P SATA CABLE ST:MD-6101108	1
	4	5060600171X00	(H)2.5 HDD MYLAR E-LIN	1
	5	4NCPM00302X00	(T)TERMINAL BLOCKS 3P PHOENIX CONTACT:1777992	1
	6	4NCPF00310X00	TERMINAL BLOCKS 3P PHOENIX CONTACT:1803581	1
	7	5061600245X00	WASHER KANGYANG:TW-320-01	12
	8	5061711760X00	MINI PCI-E BRACKET FOR NISE106 SERIES VER:A ASDA	1
	9	5044440181X00	CERAMIC THERMAL PAD FOR NDiSP2210 T.G.:XL-25	2
	10	50311P0001X00	PRICE FOR PLASTIC SCREW	2
	11	50322P0002X00	PLASTIC NUT GIN LIAN:M6HW	2
	12	50311P0020X00	F HEAD SCREW KANG YANG:M3-6F(B)	4
	13	50311F0330X00	ROUND HEAD SCREW LONG FEI:P2x3 ISO+NYLON	2
	14	50311F0295X00	FLAT HEAD SCREW LONG FEI:F2x4 NYLOK NIGP	1
	15	50344C0379X00	COPPER POST FOR NISE53 SERIES VER:A LONG FEI	1
	16	50311F0396X00	I HEAD SCREW LONG FEI:I3x3 ISO+NYLOK BLACK	1
	17	50311F0213X00	FLAT HEAD SCREW LONG FEI:F3x4ISO+NYLOK NIGP	4
	18	50311F0144X00	I HEAD SCREW LONG FEI:	2
	19	5050300264X00	HEAT SINK Shyung Shuhm:SH20200618-1	1
	20	5060200111X00	THERMAL PAD E-LIN	1
21	5060200685X00	THERMAL PAD T-GLOBAL	1	

NISE 3910P2	Item	Part Number	Description	Qty
	1	5060900292X00	WALL MOUNT BRACKET FOR NISE3600 VER:A CHYUAN-JYH	2
	2	50311F0317X00	ROUND HEAD SCREW LONG FEI:T30 P6x 10 ISO/SW13x1 with Nylok	8
	3	60233AT108X00	7P+15P SATA CABLE ST:MD-6101108	1
	4	5060600171X00	(H)2.5 HDD MYLAR E-LIN	1
	5	4NCPM00302X00	(T)TERMINAL BLOCKS 3P PHOENIX CONTACT:1777992	1
	6	4NCPF00310X00	TERMINAL BLOCKS 3P PHOENIX CONTACT:1803581	1
	7	5061600245X00	WASHER KANGYANG:TW-320-01	12
	8	5061711760X00	MINI PCI-E BRACKET FOR NISE106 SERIES VER:A ASDA	1
	9	5044440181X00	CERAMIC THERMAL PAD FOR NDiSP2210 T.G.:XL-25	2
	10	50311P0001X00	PRICE FOR PLASTIC SCREW	2
	11	50322P0002X00	PLASTIC NUT GIN LIAN:M6HW	2
	12	50311P0020X00	F HEAD SCREW KANG YANG:M3-6F(B)	4
	13	50311F0330X00	ROUND HEAD SCREW LONG FEI:P2x3 ISO+NYLON	2
	14	50311F0295X00	FLAT HEAD SCREW LONG FEI:F2x4 NYLOK NIGP	1
	15	50344C0379X00	COPPER POST FOR NISE53 SERIES VER:A LONG FEI	1
	16	50311F0396X00	I HEAD SCREW LONG FEI:I3x3 ISO+NYLOK BLACK	1
	17	50311F0213X00	FLAT HEAD SCREW LONG FEI:F3x4ISO+NYLOK NIGP	4
	18	50311F0144X00	I HEAD SCREW LONG FEI:	2
	19	5050300264X00	HEAT SINK Shyung Shuhm:SH20200618-1	1
	20	5060200111X00	THERMAL PAD E-LIN	1
21	5060200685X00	THERMAL PAD T-GLOBAL	1	

NISE 3910P2E	Item	Part Number	Description	Qty
	1	5060900292X00	WALL MOUNT BRACKET FOR NISE3600 VER:A CHYUAN-JYH	2
	2	50311F0317X00	ROUND HEAD SCREW LONG FEI:T30 P6x 10 ISO/SW13x1 with Nylok	8
	3	60233AT108X00	7P+15P SATA CABLE ST:MD-6101108	1
	4	5060600171X00	(H)2.5 HDD MYLAR E-LIN	1
	5	5061600245X00	WASHER KANGYANG:TW-320-01	12
	6	4NCPM00302X00	(T)TERMINAL BLOCKS 3P PHOENIX CONTACT:1777992	1
	7	4NCPF00310X00	TERMINAL BLOCKS 3P PHOENIX CONTACT:1803581	1
	8	5061711760X00	MINI PCI-E BRACKET FOR NISE106 SERIES VER:A ASDA	1
	9	5044440181X00	CERAMIC THERMAL PAD FOR NDiSP2210 T.G.:XL-25	2
	10	50311P0001X00	PRICE FOR PLASTIC SCREW	2
	11	50322P0002X00	PLASTIC NUT GIN LIAN:M6HW	2
	12	50311P0020X00	F HEAD SCREW KANG YANG:M3-6F(B)	4
	13	50311F0330X00	ROUND HEAD SCREW LONG FEI:P2x3 ISO+NYLON	2
	14	50311F0213X00	FLAT HEAD SCREW LONG FEI:F3x4ISO+NYLOK NIGP	4
	15	50311F0295X00	FLAT HEAD SCREW LONG FEI:F2x4 NYLOK NIGP	1
	16	50344C0379X00	COPPER POST FOR NISE53 SERIES VER:A LONG FEI	1
	17	50311F0396X00	I HEAD SCREW LONG FEI:I3x3 ISO+NYLOK BLACK	1
	18	50311F0144X00	I HEAD SCREW LONG FEI:	2
	19	5050300264X00	HEAT SINK Shyung Shuhm:SH20200618-1	1
	20	5060200111X00	THERMAL PAD E-LIN	1
21	5060200685X00	THERMAL PAD T-GLOBAL	1	

NISE 3910E16	Item	Part Number	Description	Qty
	1	6013301933X00	PAPER FOLDING FOR NISE3910E SERIES VER:A KUANGANG	2
	2	5060900292X00	WALL MOUNT BRACKET FOR NISE3600 VER:A CHYUAN-JYH	2
	3	50311F0317X00	ROUND HEAD SCREW LONG FEI:T30 P6x 10 ISO/SW13x1 with Nylok	8
	4	60233AT108X00	7P+15P SATA CABLE ST:MD-6101108	1
	5	5060600171X00	(H)2.5 HDD MYLAR E-LIN	1
	6	4NCPM00302X00	(T)TERMINAL BLOCKS 3P PHOENIX CONTACT:1777992	1
	7	4NCPF00310X00	TERMINAL BLOCKS 3P PHOENIX CONTACT:1803581	1
	8	5061600245X00	WASHER KANGYANG:TW-320-01	12
	9	5061711760X00	MINI PCI-E BRACKET FOR NISE106 SERIES VER:A ASDA	1
	10	5044440181X00	CERAMIC THERMAL PAD FOR NDiSP2210 T.G.:XL-25	2
	11	50311P0001X00	PRICE FOR PLASTIC SCREW	2
	12	50322P0002X00	PLASTIC NUT GIN LIAN:M6HW	2
	13	50311P0020X00	F HEAD SCREW KANG YANG:M3-6F(B)	4
	14	50311F0330X00	ROUND HEAD SCREW LONG FEI:P2x3 ISO+NYLON	2
	15	50311F0295X00	FLAT HEAD SCREW LONG FEI:F2x4 NYLOK NIGP	1
	16	50344C0379X00	COPPER POST FOR NISE53 SERIES VER:A LONG FEI	1
	17	50311F0396X00	I HEAD SCREW LONG FEI:I3x3 ISO+NYLOK BLACK	1
	18	50311F0213X00	FLAT HEAD SCREW LONG FEI:F3x4ISO+NYLOK NIGP	4
	19	50311F0144X00	I HEAD SCREW LONG FEI:	2
	20	5050300264X00	HEAT SINK Shyung Shuhm:SH20200618-1	1
	21	5060200111X00	THERMAL PAD E-LIN	1
22	5060200685X00	THERMAL PAD T-GLOBAL	1	

NISE 3910R	Item	Part Number	Description	Qty
	1	5060900292X00	WALL MOUNT BRACKET FOR NISE3600 VER:A CHYUAN-JYH	2
	2	50311F0317X00	ROUND HEAD SCREW LONG FEI:T30 P6x 10 ISO/SW13x1 with Nylok	8
	3	4NCPM00302X00	(T)TERMINAL BLOCKS 3P PHOENIX CONTACT:1777992	1
	4	4NCPF00310X00	TERMINAL BLOCKS 3P PHOENIX CONTACT:1803581	1
	5	5061600245X00	WASHER KANGYANG:TW-320-01	12
	6	5061711760X00	MINI PCI-E BRACKET FOR NISE106 SERIES VER:A ASDA	1
	7	5044440181X00	CERAMIC THERMAL PAD FOR NDiSP2210 T.G.:XL-25	2
	8	50311P0020X00	F HEAD SCREW KANG YANG:M3-6F(B)	8
	9	50311F0330X00	ROUND HEAD SCREW LONG FEI:P2x3 ISO+NYLON	2
	10	50311F0295X00	FLAT HEAD SCREW LONG FEI:F2x4 NYLOK NIGP	1
	11	50344C0379X00	COPPER POST FOR NISE53 SERIES VER:A LONG FEI	1
	12	50311F0396X00	I HEAD SCREW LONG FEI:I3x3 ISO+NYLOK BLACK	1
	13	5050300264X00	HEAT SINK Shyung Shuhm:SH20200618-1	1
	14	5060200111X00	THERMAL PAD E-LIN	1
	15	5060200685X00	THERMAL PAD T-GLOBAL	1

Ordering Information

The following information below provides ordering information for the NISE 3910 series.

- **Barebone**

NISE 3910E (P/N: 10J00391000X0)

Intel® 12th /13th Gen Core™ i9/i7/i5/i3 fanless system with one PCIe x4 expansion

NISE 3910E16 (P/N: 10J00391002X0)

Intel® 12th /13th Gen Core™ i9/i7/i5/i3 fanless system with one PCIe x16 expansion

NISE 3910E2 (P/N: 10J00391001X0)

Intel® 12th /13th Gen Core™ i9/i7/i5/i3 fanless system with two PCIe x4 expansions

NISE 3910P2 (P/N: 10J00391003X0)

Intel® 12th /13th Gen Core™ i9/i7/i5/i3 fanless system with two PCI expansions

NISE 3910P2E (P/N: 10J00391004X0)

Intel® 12th /13th Gen Core™ i9/i7/i5/i3 fanless system with one PCI & one PCIe x4 expansions

NISE 3910R (P/N: 10J00391005X0)

Intel® 12th /13th Gen Core™ i9/i7/i5/i3 fanless system with two outside accessible 2.5" HDD/SSD tray, support RAID 0/1

24V, 120W AC to DC power adapter w/o power cord (P/N: 7400120029X00)

24V, 180W AC to DC power adapter w/o power cord (P/N: 7400180012X00)

CHAPTER 1: PRODUCT INTRODUCTION

NISE 3910E



Front View

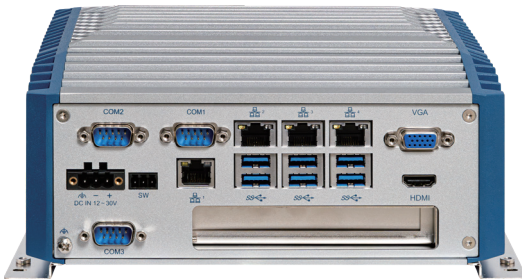

Rear View

NISE 3910E Key Features

- Support 12/13th Gen Intel® Core™ i3/i5/i7/i9 LGA1700 socket type embedded processor
- Intel® Q670E PCH
- Support 2 x DDR5 SO-DIMM socket, up to 64GB
- Four Intel® i226-IT LAN ports, support WoL, teaming, and PXE
- 1 x DP, 1 x HDMI, and 1 x VGA with independent display
- 1 x M.2 3042/3052 Key B support LTE/5G module
- 1 x Outside accessible M.2 2242 Key M with PCIe x4, support NVMe
- 6 x USB 3.1 Gen 1, 4 x USB2.0
- 2 x Isolated RS232/422/485 with auto-flow and 2 x RS232
- 1 x mini-PCIe slot, support optional Wi-Fi, 3.5G, 4G LTE
- 1 x 2.5" SATA HDD/SSD (additional 1 x 2.5" SATA upon request)
- TPM 2.0 default onboard

NISE 3910E Hardware Specifications

CPU Support

- Support 12th & 13th Gen. Intel® Core™ i3/i5/i7/i9 LGA1700 socket type embedded processors
 - Intel® Core™ i9-13900TE, 8P+16E, 1.0GHz, 36M Cache
 - Intel® Core™ i7-13700TE, 8P+8E, 1.1GHz, 30M Cache
 - Intel® Core™ i5-13500TE, 6P+8E, 1.3GHz, 24M Cache
 - Intel® Core™ i3-13100TE, 4P+4E, 2.4GHz, 12M Cache
 - Intel® Core™ i9-12900TE, 8P+8E, 1.1GHz, 30M Cache
 - Intel® Core™ i7-12700TE, 8P+4E, 1.4GHz, 25M Cache
 - Intel® Core™ i5-12500TE, 6P+6E, 1.9GHz, 18M Cache
 - Intel® Core™ i3-12100TE, 4P+4E, 2.1GHz, 12M Cache

Main Memory

- DDR5 4800 SO-DIMM socket, support up to 64GB

Display Option

- Three independent display: HDMI, DP, VGA

I/O Interface-Front

- 1 x ATX power on/off switch
- LED indicators:
 - 4 x LAN active
 - 1 x GPO status
 - 4 x COM Tx/Rx
 - 1 x HDD/SSD status
 - 1 x Battery low
 - 1 x M.2
- 1 x DP
- 2 x Antenna holes
- 1 x Outside accessible M.2 2242 Key M (PCIe x4, SATA)

- 1 x SIM card holder
- 4 x USB 2.0 Type A (500mA/port)
- 1 x Line out and 1 x mic-in

I/O Interface-Rear

- 1 x HDMI
- 1 x VGA port
- 6 x USB 3.1 Gen1 Type A (900mA per each)
- 4 x Intel® I226-IT 2.5GbE LAN ports; support WoL, teaming & PXE
- 2 x Isolated RS232/422/485
- 1 x RS232
- 1 x 3-pin DC input, support +12 to 30VDC input
- 1 x 3-pin remote power on/off switch

I/O Interface-Internal

- 8 x GPI and 8 x GPO (5V, TTL type)
- 1 x M.2 Key B 2242/3042/3052 (PCIe x2, SATA, USB3.0)
- 1 x mini-PCIe (PCIe x1, USB3.0, SATA)er on/off switch

Storage Device

- 1 x 2.5" HDD/SSD (Additional 1 x 2.5" tray upon request)
- 1 x M.2 2242 Key M, 1 x M.2 2242 Key B
- 1 x mSATA

Expansion Slot

- 1 x PCIe 4.0 x4 up to 10W/slot, Max. length: 169mm

Power Requirements

- AT/ATX power mode (Default ATX mode)
- Power input: +9 to 30VDC

Dimensions

- 215mm (W) x 272mm (D) x 102mm (H) without wall-mount bracket (8.46" x 10.7" x 4.02")

Construction

- Aluminum chassis with fanless design

Environment

- Operating temperature: Ambient with air flow: -20°C to 60°C (according to IEC60068-2-1, IEC60068-2-2, IEC60068-2-14)
- Storage temperature: -20°C to 80°C
- Relative humidity: 10% to 95% (non-condensing)
- Shock protection:
 - HDD: 20G@wallmount, half sine, 11ms(operation), IEC600682-27
 - SSD: 50G@wallmount, half sine, 11ms(operation), IEC600682-27
- Vibration protection w/ HDD condition:
 - Random: 0.5Grms@5~500Hz, IEC60068-2-64
 - Sinusoidal: 0.5Grms@5~500Hz, IEC60068-2-6
- Vibration protection w/ SSD condition:
 - Random: 2Grms@5~500 Hz, IEC60068-2-64
 - Sinusoidal: 2Grms@5~500 Hz, IEC60068-2-6

Certifications

- CE
- FCC Class A
- UL

OS Support List

- Windows 10 IoT Enterprise, 64-bit
- Windows 11

NISE 3910E Parts

Front Panel

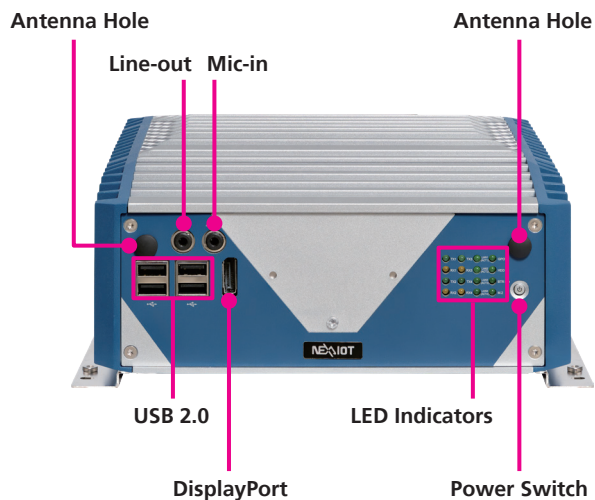

Antenna Hole

The external antenna mounting holes are used to mount and connect optional external antennas.

Line-out

Used to connect a headphone or a speaker.

Mic-in

Used to connect an external microphone.

USB 2.0

Used to connect USB 2.0/1.1 devices.

DisplayPort

Used to connect a DisplayPort interface monitor.

LED Indicators

Indicate the COM port, LAN, GPO, storage, and M.2 activity as well as the low battery status of the system.

Power Switch

Press to power-on or power-off the system.

Rear Panel

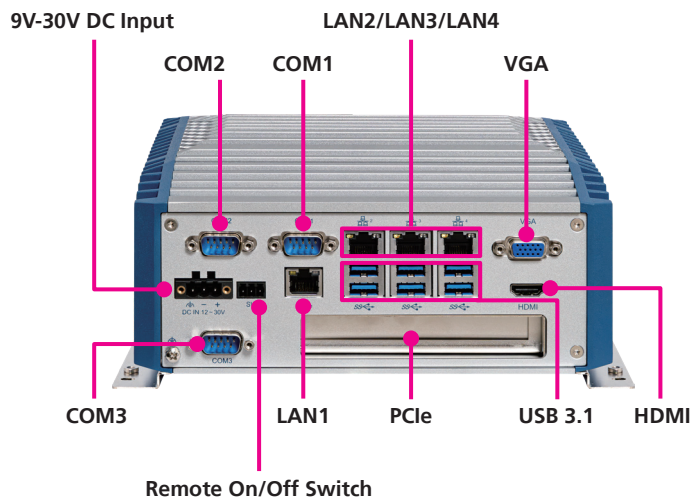

LAN1 and LAN2 support the Preboot eXecution Environment (PxE), defaulted to disabled in BIOS for booting from the LAN, as well as Wake-on-LAN (WoL) functionality.

9V-30V DC Input

Used to plug a DC power cord.

COM1 and COM2

DB9 ports used to connect RS232/422/485 compatible devices.

LAN2*/LAN3/LAN4

Used to connect the system to a local area network.

VGA

Used to connect a VGA interface monitor.

COM3

DB9 port used to connect RS232 device.

Remote On/Off Switch

Used to connect a remote to power on/off the system.

LAN1*

Used to connect the system to a local area network.

PCIe Expansion Slot

Used to install a PCIe add-on card.

USB3.1 Gen 1

Used to connect USB 3.1/2.0 devices.

HDMI

Used to connect an HDMI interface monitor.

NISE 3910E Mechanical Dimensions

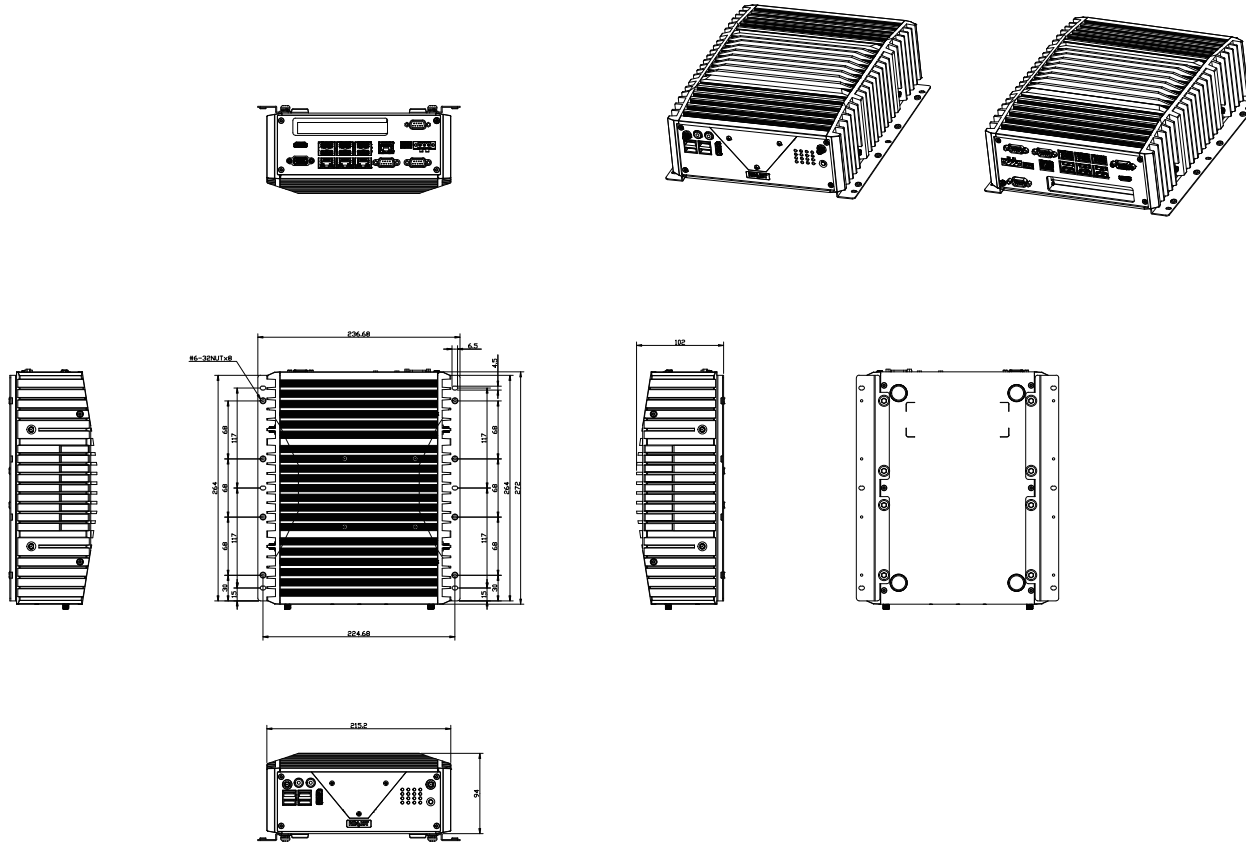

NISE 3910E16/E2/P2/P2E



Front View



Rear View

Key Features

- Support 12/13th Gen Intel® Core™ i3/i5/i7/i9 LGA1700 socket type embedded processor
- Intel® Q670E PCH
- Support 2 x DDR5 SO-DIMM socket, up to 64GB
- Four Intel® i226-IT LAN ports, support WoL, teaming, and PXE
- 1 x DP, 1 x HDMI, and 1 x VGA with independent display
- 1 x M.2 3042/3052 Key B support LTE/5G module
- 1 x Outside accessible M.2 2242 Key M with PCIe x4, support NVMe
- 6 x USB3.1 Gen 1, 4 x USB2.0
- 2 x Isolated RS232/422/485 with auto-flow and 2 x RS232
- 1 x mini-PCIe slot, support optional Wi-Fi, 3.5G, 4G LTE
- 1 x 2.5" SATA HDD/SSD (additional 1 x 2.5" SATA upon request)
- TPM 2.0 default onboard

NISE 3910E16/E2/P2/P2E Hardware Specifications

CPU Support

- Support 12th & 13th Gen. Intel® Core™ i3/i5/i7/i9 LGA1700 socket type embedded processors
 - Intel® Core™ i9-13900TE, 8P+16E, 1.0GHz, 36M Cache
 - Intel® Core™ i7-13700TE, 8P+8E, 1.1GHz, 30M Cache
 - Intel® Core™ i5-13500TE, 6P+8E, 1.3GHz, 24M Cache
 - Intel® Core™ i3-13100TE, 4P+4E, 2.4GHz, 12M Cache
 - Intel® Core™ i9-12900TE, 8P+8E, 1.1GHz, 30M Cache
 - Intel® Core™ i7-12700TE, 8P+4E, 1.4GHz, 25M Cache
 - Intel® Core™ i5-12500TE, 6P+6E, 1.9GHz, 18M Cache
 - Intel® Core™ i3-12100TE, 4P+4E, 2.1GHz, 12M Cache

Main Memory

- DDR5 4800 SO-DIMM socket, support up to 64GB

Display Option

- Three independent display: HDMI, DP, VGA

I/O Interface-Front

- 1 x ATX power on/off switch
- LED indicators:
 - 4 x LAN active
 - 1 x GPO status
 - 4 x COM Tx/Rx
 - 1 x HDD/SSD status
 - 1 x Battery low
 - 1 x M.2
- 1 x DP
- 2 x Antenna holes
- 1 x Outside accessible M.2 2242 Key M (PCIe x4, SATA)

- 1 x SIM card holder
- 4 x USB 2.0 Type A (500mA/port)
- 1 x Line out and 1 x mic-in

I/O Interface-Rear

- 1 x HDMI
- 1 x VGA port
- 6 x USB3.1 Gen 1 Type A (900mA per each)
- 4 x Intel® I226-IT 2.5GbE LAN ports; support WoL, teaming & PXE
- 2 x Isolated RS232/422/485
- 2 x RS232
- 1 x 3-pin DC input, support +12 to 30VDC input
- 1 x 3-pin remote power on/off switch

I/O Interface-Internal

- 8 x GPI and 8 x GPO (5V, TTL type)
- 1 x M.2 Key B 2242/3042/3052 (PCIe x2, SATA, USB3.0)
- 1 x mini-PCIe (PCIe x1, USB3.0, SATA)

Storage Device

- 1 x 2.5" HDD/SSD (Additional 1 x 2.5" tray upon request)
- 1 x M.2 2242 Key M, 1 x M.2 2242 Key B
- 1 x mSATA

Expansion Slot

- 1 x PCIe 4.0 x16 (NISE 3910E16) up to 75W, Max. length: 240mm
- 2 x PCIe 4.0 x4 (NISE 3910E2) up to 10W/slot, Max. length: 169mm & 240mm
- 2 x PCI (NISE 3910P2) up to 10W/slot, Max. length: 169mm & 240mm
- 1 x PCIe 4.0 x4 + 1 x PCI (NISE 3910P2E) up to 10W/slot, Max. length: 169mm & 240mm

Power Requirements

- AT/ATX power mode (Default ATX mode)
- Power input: +9 to 30VDC

Dimensions

- 215mm (W) x 272mm (D) x 123mm (H) without wall-mount bracket (8.46" x 10.7" x 4.8")

Construction

- Aluminum chassis with fanless design

Environment

- Operating temperature: Ambient with air flow: -20°C to 60°C (according to IEC60068-2-1, IEC60068-2-2, IEC60068-2-14)
- Storage temperature: -20°C to 80°C
- Relative humidity: 10% to 95% (non-condensing)
- Shock protection:
 - HDD: 20G@wallmount, half sine, 11ms(operation), IEC600682-27
 - SSD: 50G@wallmount, half sine, 11ms(operation), IEC600682-27
- Vibration protection w/ HDD condition:
 - Random: 0.5Grms@5~500Hz, IEC60068-2-64
 - Sinusoidal: 0.5Grms@5~500Hz, IEC60068-2-6

- Vibration protection w/ SSD condition:
 - Random: 2Grms@5~500 Hz, IEC60068-2-64
 - Sinusoidal: 2Grms@5~500 Hz, IEC60068-2-6

Certifications

- CE
- FCC Class A
- UL

OS Support List

- Windows 10 IoT Enterprise, 64-bit
- Windows 11

NISE 3910E16/E2/P2/P2E Parts

Front Panel

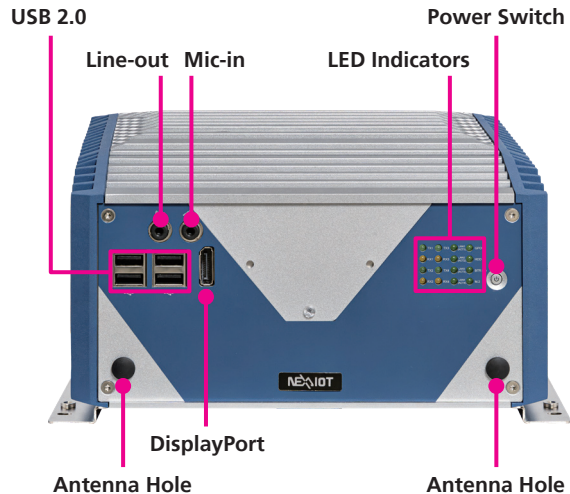

USB 2.0

Used to connect USB 2.0/1.1 devices.

Line-out

Used to connect a headphone or a speaker.

Mic-in

Used to connect an external microphone.

LED Indicators

Indicate the COM port, LAN, GPO, storage, and M.2 activity as well as the low battery status of the system.

Power Switch

Press to power-on or power-off the system.

Antenna Hole

The external antenna mounting holes are used to mount and connect optional external antennas.

DisplayPort

Used to connect a DisplayPort interface monitor.

Rear Panel

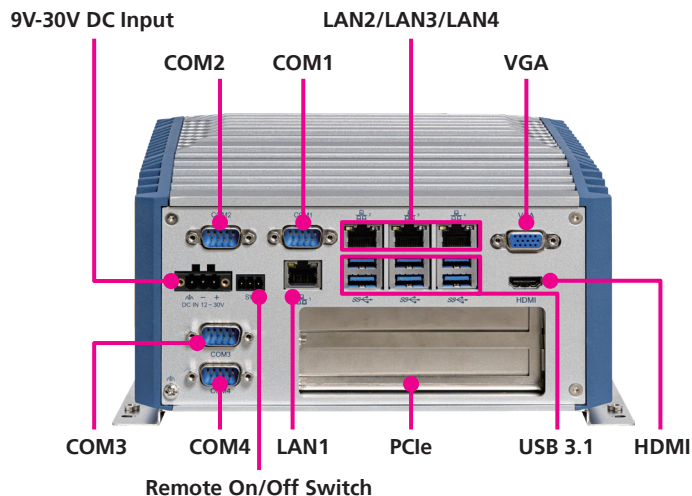

LAN1 and LAN2 support the Preboot eXecution Environment (PxE), defaulted to disabled in BIOS for booting from the LAN, as well as Wake-on-LAN (WoL) functionality.

9V-30V DC Input

Used to plug a DC power cord.

COM1 and COM2

DB9 ports used to connect RS232/422/485 compatible devices.

LAN2*/LAN3/LAN4

Used to connect the system to a local area network.

VGA

Used to connect a VGA interface monitor.

COM3 and COM4

DB9 ports used to connect RS232 device.

Remote On/Off Switch

Used to connect a remote to power on/off the system.

LAN1*

Used to connect the system to a local area network.

PCIe Expansion Slot

Used to install PCIe add-on cards.

USB3.1 Gen 1

Used to connect USB 3.1/2.0 devices.

HDMI

Used to connect an HDMI interface monitor.

NISE 3910E16/E2/P2/P2E Mechanical Dimensions

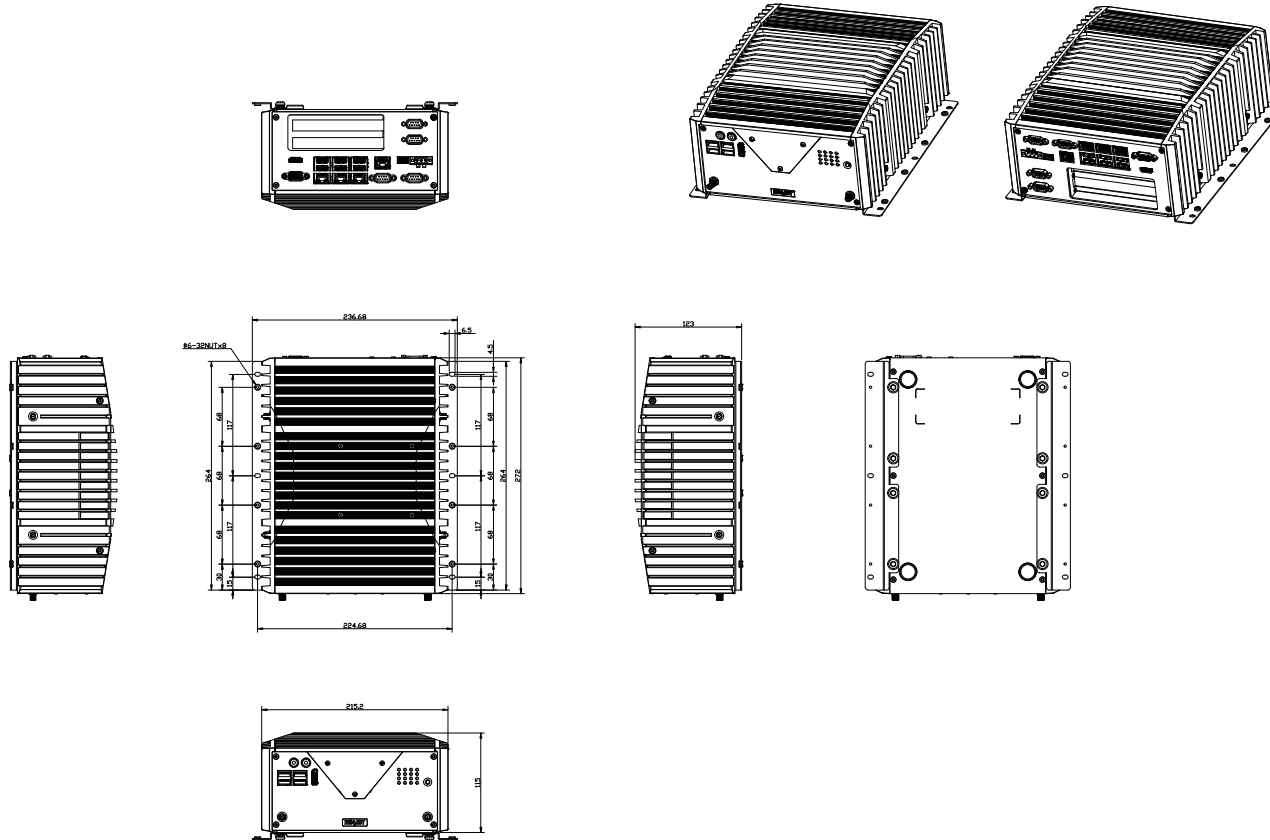

NISE 3910R



Front View



Rear View

Key Features

- Support 12/13th Gen Intel® Core™ i3/i5/i7/i9 LGA1700 socket type embedded processor
- Intel® Q670E PCH
- Support 2 x DDR5 SO-DIMM socket, up to 64GB
- Four Intel® i226-IT LAN ports, support WoL, teaming, and PXE
- 1 x DP, 1 x HDMI, and 1 x VGA with independent display
- 1 x M.2 3042/3052 Key B support LTE/5G module
- 1 x Outside accessible M.2 2242 Key M with PCIe x4, support NVMe
- 6 x USB 3.1 Gen 1, 4 x USB2.0
- 2 x Isolated RS232/422/485 with auto-flow
- 1 x mini-PCIe slot, support optional Wi-Fi, 3.5G, 4G LTE
- 2 x 2.5" SATA HDD/SSD
- TPM 2.0 default onboard

NISE 3910R Hardware Specifications

CPU Support

- Support 12th & 13th Gen. Intel® Core™ i3/i5/i7/i9 LGA1700 socket type embedded processors
 - Intel® Core™ i9-13900TE, 8P+16E, 1.0GHz, 36M Cache
 - Intel® Core™ i7-13700TE, 8P+8E, 1.1GHz, 30M Cache
 - Intel® Core™ i5-13500TE, 6P+8E, 1.3GHz, 24M Cache
 - Intel® Core™ i3-13100TE, 4P+4E, 2.4GHz, 12M Cache
 - Intel® Core™ i9-12900TE, 8P+8E, 1.1GHz, 30M Cache
 - Intel® Core™ i7-12700TE, 8P+4E, 1.4GHz, 25M Cache
 - Intel® Core™ i5-12500TE, 6P+6E, 1.9GHz, 18M Cache
 - Intel® Core™ i3-12100TE, 4P+4E, 2.1GHz, 12M Cache

Main Memory

- DDR5 4800 SO-DIMM socket, support up to 64GB

Display Option

- Three independent display: HDMI, DP, VGA

I/O Interface-Front

- 1 x ATX power on/off switch
- LED indicators:
 - 4 x LAN active
 - 1 x GPO status
 - 4 x COM Tx/Rx
 - 1 x HDD/SSD status
 - 1 x Battery low
 - 1 x M.2
- 1 x DP
- 2 x Antenna holes
- 1 x Outside accessible M.2 2242 Key M (PCIe x4, SATA)

- 1 x SIM card holder
- 4 x USB 2.0 Type A (500mA/port)
- 1 x Line out and 1 x mic-in

I/O Interface-Rear

- 1 x HDMI
- 1 x VGA port
- 6 x USB 3.1 Gen1 Type A (900mA per each)
- 4 x Intel® I226-IT 2.5GbE LAN ports; support WoL, teaming & PXE
- 2 x Isolated RS232/422/485
- 1 x 3-pin DC input, support +12 to 30VDC input
- 1 x 3-pin remote power on/off switch

I/O Interface-Internal

- 8 x GPI and 8 x GPO (5V, TTL type)
- 1 x M.2 Key B 2242/3042/3052 (PCIe x2, SATA, USB3.0)
- 1 x mini-PCIe (PCIe x1, USB3.0, SATA)

Storage Device

- 2 x 2.5" HDD/SSD
- 1 x M.2 2242 Key M, 1 x M.2 2242 Key B
- 1 x mSATA

Power Requirements

- AT/ATX power mode (Default ATX mode)
- Power input: +9 to 30VDC

Dimensions

- 215mm (W) x 272mm (D) x 102mm (H) without wall-mount bracket (8.46" x 10.7" x 4.02")

Construction

- Aluminum chassis with fanless design

Environment

- Operating temperature: Ambient with air flow: -20°C to 60°C (according to IEC60068-2-1, IEC60068-2-2, IEC60068-2-14)
- Storage temperature: -20°C to 80°C
- Relative humidity: 10% to 95% (non-condensing)
- Shock protection:
 - HDD: 20G@wallmount, half sine, 11ms(operation), IEC600682-27
 - SSD: 50G@wallmount, half sine, 11ms(operation), IEC600682-27
- Vibration protection w/ HDD condition:
 - Random: 0.5Grms@5~500Hz, IEC60068-2-64
 - Sinusoidal: 0.5Grms@5~500Hz, IEC60068-2-6
- Vibration protection w/ SSD condition:
 - Random: 2Grms@5~500 Hz, IEC60068-2-64
 - Sinusoidal: 2Grms@5~500 Hz, IEC60068-2-6

Certifications

- CE
- FCC Class A
- UL

OS Support List

- Windows 10 IoT Enterprise, 64-bit
- Windows 11

NISE 3910R Parts

Front Panel

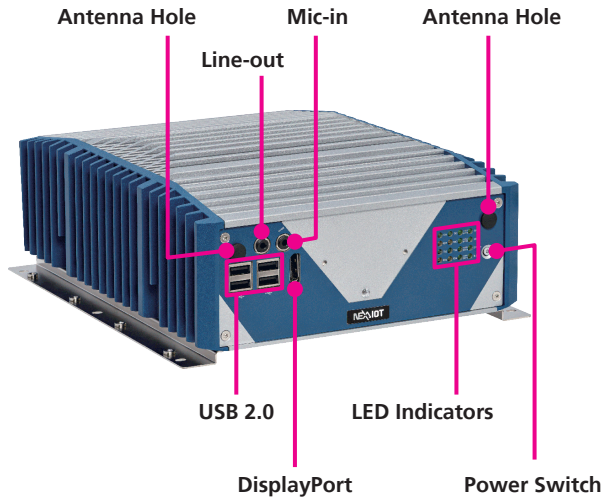

Antenna Hole

The external antenna mounting holes are used to mount and connect optional external antennas.

Line-out

Used to connect a headphone or a speaker.

Mic-in

Used to connect an external microphone.

USB 2.0

Used to connect USB 2.0/1.1 devices.

DisplayPort

Used to connect a DisplayPort interface monitor.

LED Indicators

Indicate the COM port, LAN, GPO, storage, and M.2 activity as well as the low battery status of the system.

Power Switch

Press to power-on or power-off the system.

Rear Panel

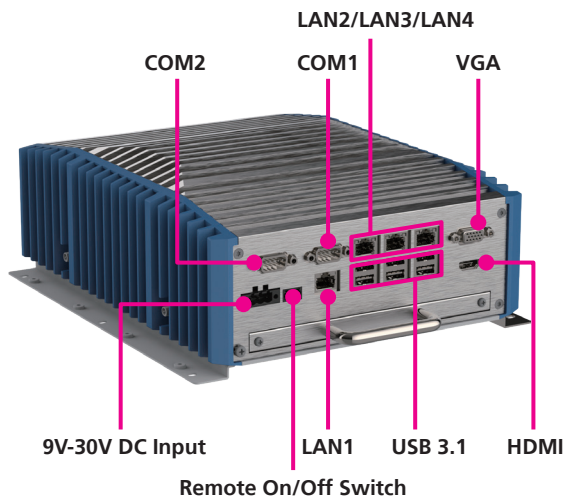

COM1 and COM2

DB9 ports used to connect RS232/422/485 compatible devices.

LAN2*/LAN3/LAN4

Used to connect the system to a local area network.

VGA

Used to connect a VGA interface monitor.

9V-30V DC Input

Used to plug a DC power cord.

Remote On/Off Switch

Used to connect a remote to power on/off the system.

LAN1*

Used to connect the system to a local area network.

USB 3.1 Gen 1

Used to connect USB 3.1/2.0 devices.

HDMI

Used to connect an HDMI interface monitor.



LAN1 and LAN2 support the Preboot eXecution Environment (PxE), defaulted to disabled in BIOS for booting from the LAN, as well as Wake-on-LAN (WoL) functionality.

NISE 3910R Mechanical Dimensions

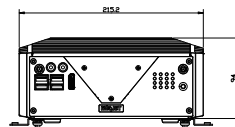
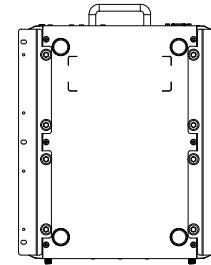
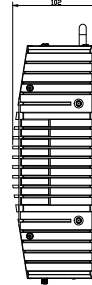
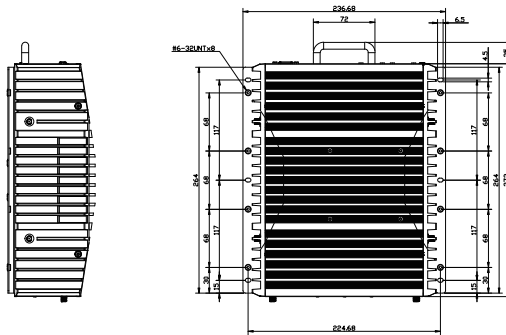
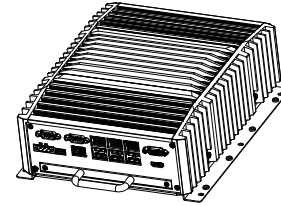
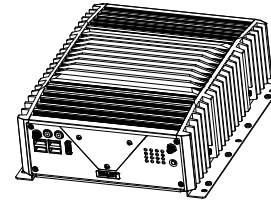
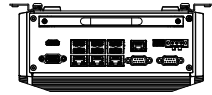

CHAPTER 2: JUMPERS AND CONNECTORS

This chapter describes how to set the jumpers and connectors on the NISE 3900 series motherboard.

Before You Begin

- Ensure you have a stable, clean working environment. Dust and dirt can get into components and cause a malfunction. Use containers to keep small components separated.
- Adequate lighting and proper tools can prevent you from accidentally damaging the internal components. Most of the procedures that follow require only a few simple tools, including the following:
 - A Philips screwdriver
 - A flat-tipped screwdriver
 - A set of jewelers screwdrivers
 - A grounding strap
 - An anti-static pad
- Using your fingers can disconnect most of the connections. It is recommended that you do not use needle-nosed pliers to disconnect connections as these can damage the soft metal or plastic parts of the connectors.
- Before working on internal components, make sure that the power is off. Ground yourself before touching any internal components, by touching a metal object. Static electricity can damage many of the electronic components. Humid environments tend to have less static electricity than

dry environments. A grounding strap is warranted whenever danger of static electricity exists.

Precautions

Computer components and electronic circuit boards can be damaged by discharges of static electricity. Working on computers that are still connected to a power supply can be extremely dangerous.

Follow the guidelines below to avoid damage to your computer or yourself:

- Always disconnect the unit from the power outlet whenever you are working inside the case.
- If possible, wear a grounded wrist strap when you are working inside the computer case. Alternatively, discharge any static electricity by touching the bare metal chassis of the unit case, or the bare metal body of any other grounded appliance.
- Hold electronic circuit boards by the edges only. Do not touch the components on the board unless it is necessary to do so. Don't flex or stress the circuit board.
- Leave all components inside the static-proof packaging that they shipped with until they are ready for installation.
- Use correct screws and do not over tighten screws.

Jumper Settings

A jumper is the simplest kind of electric switch. It consists of two metal pins and a cap. When setting the jumpers, ensure that the jumper caps are placed on the correct pins. When the jumper cap is placed on both pins, the jumper is short. If you remove the jumper cap, or place the jumper cap on just one pin, the jumper is open.

Refer to the illustrations below for examples of what the 2-pin and 3-pin jumpers look like when they are short (on) and open (off).

Two-Pin Jumpers: Open (Left) and Short (Right)

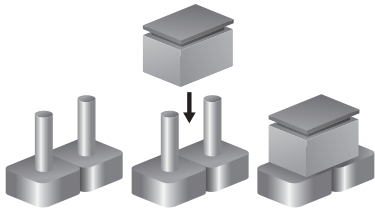

Three-Pin Jumpers: Pins 1 and 2 are Short

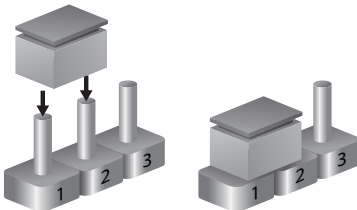

Locations of the Jumpers and Connectors for the NISE 3910 Series

The following figures show the motherboard used in the NISE 3910 series, indicating the locations of jumpers and connectors. Refer to this chapter for detailed pin settings and definitions of connectors marked in pink on these figures.

Top View

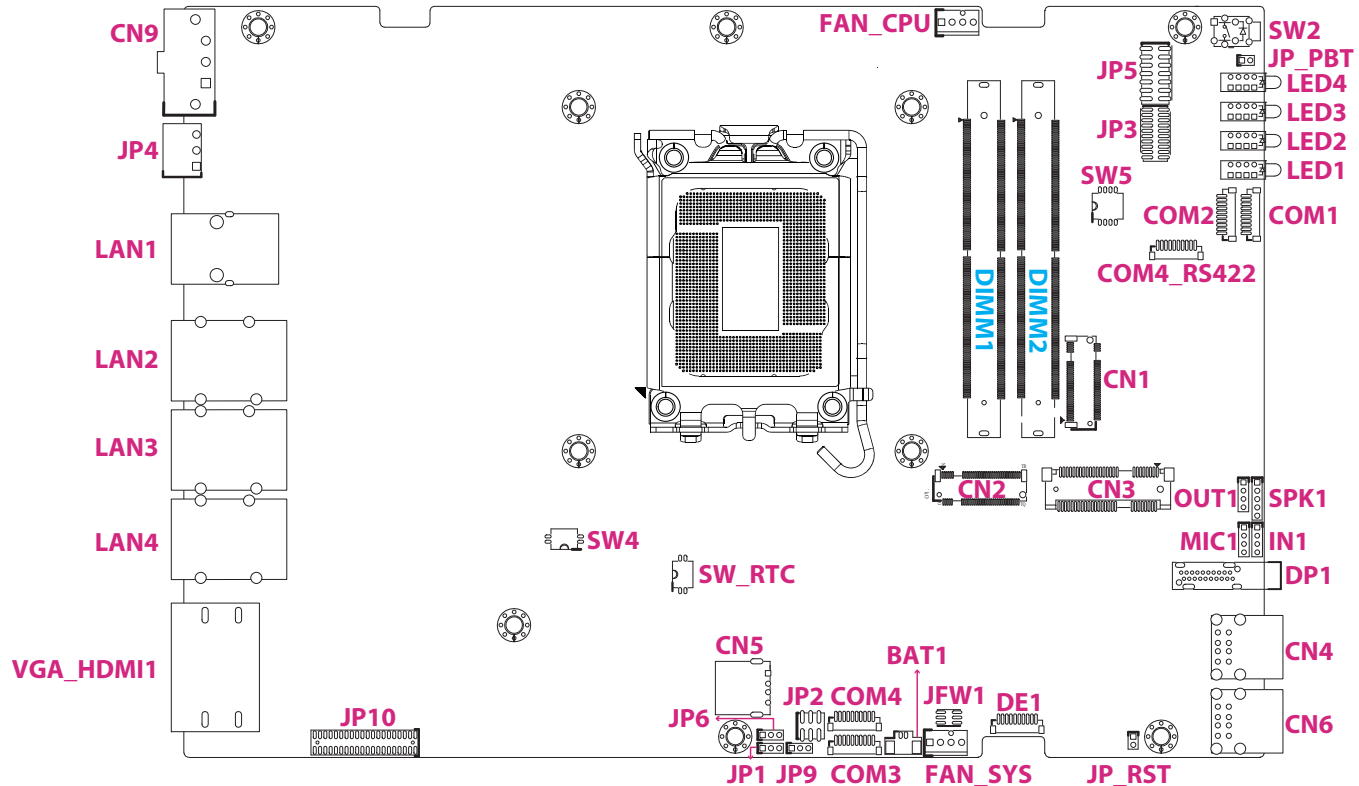

Bottom View

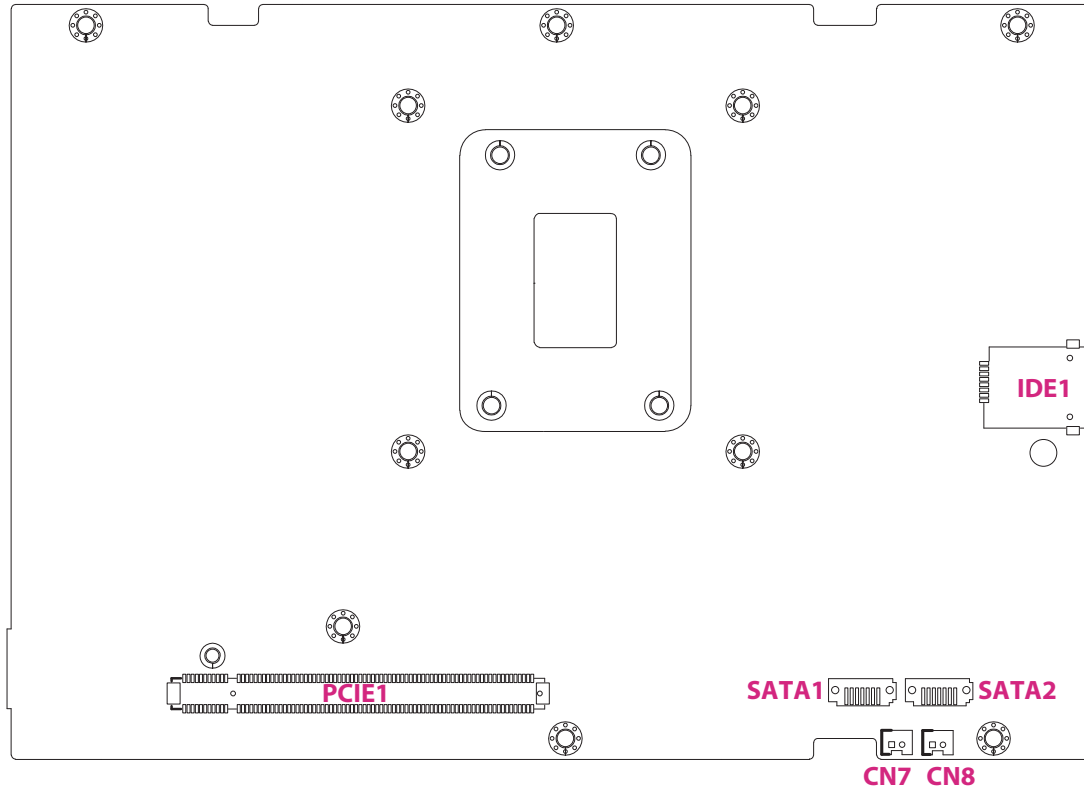

Jumpers and DIP Switch Settings

COM3 Power Output Select

Connector location: JP2

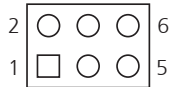

Pin	Settings
1-2 On	5V
3-4 On	12V
5-6 On	RI

Pin	Definition
1	VCC5
2	RI_VCC12_VCC5
3	VCC12
4	VCC12_VCC5
5	COM3_RIL
6	RI_VCC12_VCC5

AT/ATX Power Select

Connector location: JP9



Pin	Settings
1-2 On	AT Mode
2-3 On	ATX Mode (Default)

Pin	Settings
1	AT_PWRBT#
2	S_PWRBTN#
3	ATX_PWRBT#

PCIe Select

Connector location: SW4



Pin		Settings
1	On	One PCIe 4.0 x16 reversed
	Off	One PCIe 4.0 x16 normal (Default)
2	On	Two PCIe slots 4.0 x8
	Off	One PCIe 4.0 x16 (Default)

Pin	Settings
1	CFG2
2	CFG3
3	GND
4	GND

Clear CMOS

Connector location: SW_RTC



Pin	Settings
All off	Normal (Default)
All on	Clear CMOS

Pin	Settings
1	RTCST_N
2	SRTCST_N
3	GND
4	GND

Connector Pin Definitions

External I/O Interfaces - Front Panel

USB 2.0 Ports

Connector location: CN4

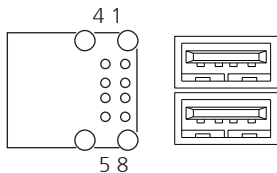

Pin	Definition	Pin	Definition
1	5VUSB2_P1	5	5VUSB2_P1
2	USB2N_10	6	USB2N_11
3	USB2P_10	7	USB2P_11
4	GND	8	GND

USB 2.0 Ports

Connector location: CN6

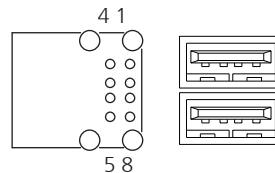

Pin	Definition	Pin	Definition
1	5VUSB2_P2	5	5VUSB2_P2
2	USB2N_12	6	USB2N_13
3	USB2P_12	7	USB2P_13
4	GND	8	GND

DisplayPort

Connector location: DP1

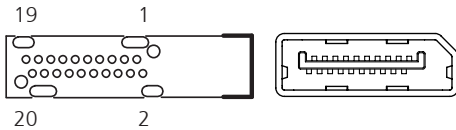

Pin	Definition	Pin	Definition
1	LANE0_P	2	GND
3	LANE0_N	4	LANE1_P
5	GND	6	LANE1_N
7	LANE2_P	8	GND
9	LANE2_N	10	LANE3_P
11	GND	12	LANE3_N
13	CONFIG1	14	CONFIG2
15	AUX_P	16	GND
17	AUX_N	18	DPHPD
19	GND	20	3V3DPPWR

LED Indicators

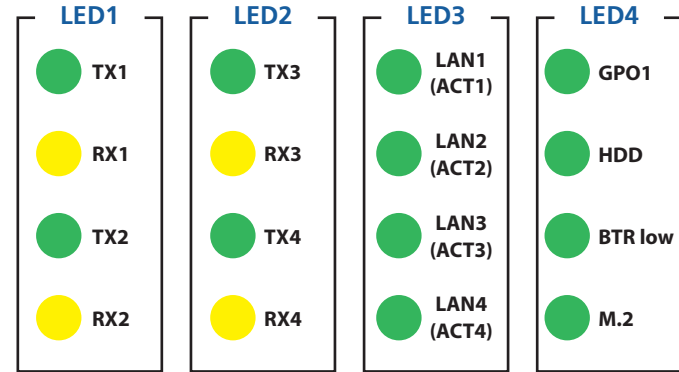

TX1/RX1 represents the LED light for COM port1, and so on up to COM port 4.

LED1

LED light: Green (LED1/3), Yellow (LED2/4)

Connector location: LED1

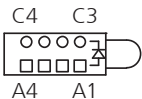

Pin	Definition	Pin	Definition
A1	RX2_P	C1	COM2_RXLEDN
A2	TX2_P	C2	COM2_TXLEDN
A3	RX1_P	C3	COM1_RXLEDN
A4	TX1_P	C4	COM1_TXLEDN

LED2

LED light: Green (LED1/3), Yellow (LED2/4)

Connector location: LED2

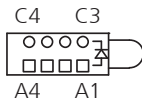

Pin	Definition	Pin	Definition
A1	RX4_P	C1	COM4_RXLEDN
A2	TX4_P	C2	COM4_TXLEDN
A3	RX3_P	C3	COM3_RXLEDN
A4	TX3_P	C4	COM3_TXLEDN

LED3

LED light: Green

Connector location: LED3

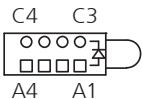

Pin	Definition	Pin	Definition
A1	LAN4_ACT#_LED_P	C1	LAN4_LEDACTL
A2	LAN3_ACT#_LED_P	C2	LAN3_LEDACTL
A3	LAN2_ACT#_LED_P	C3	LAN2_LEDACTL
A4	LAN1_ACT#_LED_P	C4	LAN1_LEDACTL

LED4

LED light: Green

Connector location: LED4

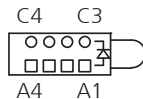

Pin	Definition	Pin	Definition
A1	LAN4_ACT#_LED_P	C1	LAN4_LEDACTL
A2	LAN3_ACT#_LED_P	C2	LAN3_LEDACTL
A3	LAN2_ACT#_LED_P	C3	LAN2_LEDACTL
A4	LAN1_ACT#_LED_P	C4	LAN1_LEDACTL

Power Button

Connector location: SW2

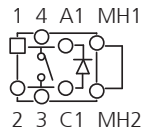

Pin	Definition	Pin	Definition
1	GND	2	PBT_PU
3	PBT_PU	4	GND
A1	LED+	C1	LED-
MH1	NC	MH2	NC

External I/O Interfaces - Rear Panel

DC Power Input

Connector location: CN9

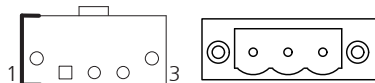

Pin	Definition
1	VINPIN1
2	VINVSS
3	VINPIN3

Remote Power On/Off

Connector location: JP4



Pin	Definition
1	PWRBTN#_J
2	GND
3	SLPS3_RM

LAN Port 1

Connector location: LAN1

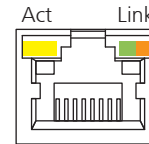
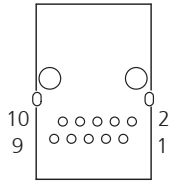

Pin	Definition	Pin	Definition
1	LAN1_MDIAP	2	LAN1_MDIAN
3	LAN1_MDIBP	4	LAN1_MDIBN
5	LAN1TVCC1	6	GND
7	LAN1_MDICP	8	LAN1_MDICN
9	LAN1_MDIDP	10	LAN1_MDIDN
11	LAN1_LED2500L_R	12	LAN1_LED1GL_R
13	LAN1_LEDACTL_R	14	V3P3A_LAN1

Act	Status
Flashing Yellow	Data activity
Off	No activity

Link	Status
Steady Green	2.5G/1G network link
Steady Orange	100Mbps network link
Off	10Mbps



LAN1 and LAN2 support the Preboot eXecution Environment (PxE), defaulted to disabled in BIOS for booting from the LAN, as well as Wake-on-LAN (WoL) functionality.

LAN Port 2 + USB 3.1 Gen1

Connector location: LAN2

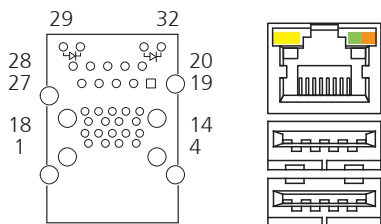

Pin	Definition	Pin	Definition
1	5VUSB3_P1	2	USB2N_1
3	USB2P_1	4	GND
5	USB32_RXN1	6	USB32_RXP1
7	GND	8	USB32_TXN1
9	USB32_TXP1	10	5VUSB3_P1
11	USB2N_2	12	USB2P_2
13	GND	14	USB32_RXN2
15	USB32_RXP2	16	GND

Pin	Definition	Pin	Definition
17	USB32_TXN2	18	USB32_TXP2
19	LAN2TVCC1	20	LAN2_MDIAP
21	LAN2_MDIAN	22	LAN2_MDIBP
23	LAN2_MDIBN	24	LAN2_MDICP
25	LAN2_MDICN	26	LAN2_MDIDP
27	LAN2_MDIDN	28	GND
29	V3P3A_LAN2	30	LAN2_LEDCTL_R
31	LAN2_LED1GL_R	32	LAN2_LED2500L_R



LAN1 and LAN2 support the Preboot eXecution Environment (PxE), defaulted to disabled in BIOS for booting from the LAN, as well as Wake-on-LAN (WoL) functionality.



For more information of LAN port LED indicators, refer to the descriptions provided on the [LAN port 1](#) page.

LAN Port 3 + USB 3.1 Gen1

Connector location: LAN3

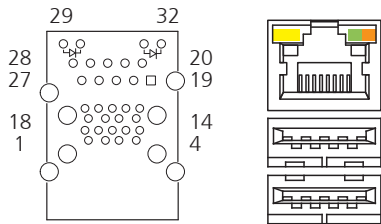

Pin	Definition	Pin	Definition
1	5VUSB3_P2	2	USB2N_3
3	USB2P_3	4	GND
5	USB32_RXN3	6	USB32_RXP3
7	GND	8	USB32_TXN3
9	USB32_TXP3	10	5VUSB3_P2
11	USB2N_4	12	USB2P_4
13	GND	14	USB32_RXN4
15	USB32_RXP4	16	GND

Pin	Definition	Pin	Definition
17	USB32_TXN4	18	USB32_TXP4
19	LAN3TVCC1	20	LAN3_MDIAP
21	LAN3_MDIAN	22	LAN3_MDIBP
23	LAN3_MDIBN	24	LAN3_MDICP
25	LAN3_MDICN	26	LAN3_MDIDP
27	LAN3_MDIDN	28	GND
29	V3P3A_LAN3	30	LAN3_LEDCTL_R
31	LAN3_LED1GL_R	32	LAN3_LED2500L_R



For more information of LAN port LED indicators, refer to the descriptions provided on the [LAN port 1](#) page.

LAN Port 4 + USB 3.1 Gen1

Connector location: LAN4

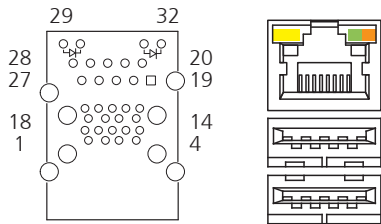

Pin	Definition	Pin	Definition
1	5VUSB3_P3	2	USB2N_5
3	USB2P_5	4	GND
5	USB32_RXN5	6	USB32_RXP5
7	GND	8	USB32_TXN5
9	USB32_TXP5	10	5VUSB3_P3
11	USB2N_6	12	USB2P_6
13	GND	14	USB32_RXN6
15	USB32_RXP6	16	GND

Pin	Definition	Pin	Definition
17	USB32_TXN6	18	USB32_TXP6
19	LAN4TVCC1	20	LAN4_MDIAP
21	LAN4_MDIAN	22	LAN4_MDIBP
23	LAN4_MDIBN	24	LAN4_MDICP
25	LAN4_MDICN	26	LAN4_MDIDP
27	LAN4_MDIDN	28	GND
29	V3P3A_LAN4	30	LAN4_LEDCTL_R
31	LAN4_LED1GL_R	32	LAN4_LED2500L_R



For more information of LAN port LED indicators, refer to the descriptions provided on the [LAN port 1](#) page.

VGA + HDMI

Connector location: VGA_HDMI1

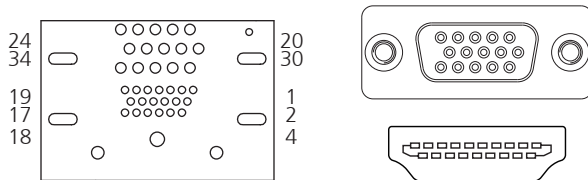

Pin	Definition	Pin	Definition
A1	HDMITX2P1	A2	GND
A3	HDMITX2N1	A4	HDMITX1P1
A5	GND	A6	HDMITX1N1
A7	HDMITX0P1	A8	GND
A9	HDMITX0N1	A10	HDMICLK1P1
A11	GND	A12	HDMICLK1N1
A15	HDMIDDCSCL	A16	HDMIDDCCSDA
A17	GND	A18	VCC5HDMI
A19	HDMIHPD		

Pin	Definition	Pin	Definition
B20	RED_VGA	B21	GREEN_VGA
B22	BLUE_VGA	B23	NC
B24	GND	B25	GND
B26	GND	B27	GND
B28	VGA_+5V	B29	GND
B30	NC	B31	VGA_SDA_C
B32	HSYNC_VGA	B33	VSYNC_VGA
B34	GND		

Internal Connectors - Top Side

Audio Connectors

Connector location: IN1, MIC1, OUT1, SPK1

IN1: 1  4

MIC1: 1  4

IN1

Pin	Definition
1	LINE1-L1
2	AGND
3	LINEIN_JD
4	LINE1-R1

MIC1

Pin	Definition
1	MIC_OUT-L
2	AGND
3	MIC_JD
4	MIC_OUT-R

Connector location: OUT1, SPK1

OUT1: 1  4

SPK1: 1  4

OUT1

Pin	Definition
1	LINE_OUT_LC
2	AGND
3	LINEOUT_JD
4	LINE_OUT_RC1

SPK1

Pin	Definition
1	OUT-LR+_C
2	OUT-LR-_C
3	AGND
4	OUT-RR+_C
5	OUT-RR-_C

RTC Battery Connector

Connector location: BAT1

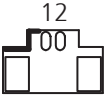

Pin	Definition
1	GND
2	3V_BAT1

M.2 Key B

Connector type: M.2 Key B for PCIe/SATA/USB3.2/USB2.0

Connector location: CN2

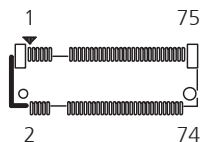

Pin	Definition	Pin	Definition
1	GND	2	M2LTEPWR
3	GND	4	M2LTEPWR
5	GND	6	M2POWEROFF
7	USB_M2B_DP	8	M2LTEDISL
9	USB_M2B_DN	10	M2SATADSSL
11	GND	12	
13		14	
15		16	
17		18	

Pin	Definition	Pin	Definition
19		20	
21	M2LTECONFIG0	22	NC
23	NC	24	NC
25	NC	26	NC
27	GND	28	BKEY_UIM_VPP
29	USB_M2B_RXN	30	BKEY_UIM_RESET
31	USB_M2B_RXP	32	BKEY_UIM_CLK
33	GND	34	BKEY_UIM_DATA
35	USB_M2B_TXN	36	BKEY_UIM_PWR

Continued on next page

Pin	Definition	Pin	Definition
37	USB_M2B_TXP	38	NC
39	GND	40	NC
41	NGFF_PE_SSD_RXP1	42	NC
43	NGFF_PE_SSD_RXN1	44	NC
45	GND	46	NC
47	NGFF_PE_SSD_TXN1	48	NC
49	NGFF_PE_SSD_TXP1	50	M2B_PLTRSTN
51	GND	52	SRCCLKREQ3L_M2B
53	CLK_PCIE_M2B_N	54	I_WAKEN
55	CLK_PCIE_M2B_P	56	NC

Pin	Definition	Pin	Definition
57	GND	58	NC
59	NC	60	NC
61	NC	62	NC
63	NC	64	NC
65	NC	66	NC
67	M2LTERSTL	68	M2SUSCLK
69	M2LTECONFIG1	70	M2LTPWR
71	GND	72	M2LTPWR
73	GND	74	M2LTPWR
75	M2LTECONFIG2		

M.2 Key M

Connector type: M.2 Key M for PCIe/SATA

Connector location: CN1

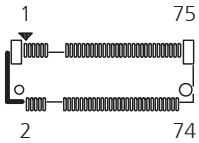

Pin	Definition	Pin	Definition
1	GND	2	M2MKEYPWR
3	GND	4	M2MKEYPWR
5	H_PCIEM2MRXN3	6	NC
7	H_PCIEM2MRXP3	8	NC
9	GND	10	M2SATADSSL
11	H_PCIEM2MTXN3	12	M2MKEYPWR
13	H_PCIEM2MTXP3	14	M2MKEYPWR
15	GND	16	M2MKEYPWR
17	H_PCIEM2MRXN2	18	M2MKEYPWR

Pin	Definition	Pin	Definition
19	H_PCIEM2MRXP2	20	NC
21	GND	22	NC
23	H_PCIEM2MTXN2	24	NC
25	H_PCIEM2MTXP2	26	NC
27	GND	28	NC
29	H_PCIEM2MRXN1	30	NC
31	H_PCIEM2MRXP1	32	NC
33	GND	34	NC
35	H_PCIEM2MTXN1	36	NC

Continued on next page

Pin	Definition	Pin	Definition
37	H_PCIEM2MTXP1	38	DEVSLP_0
39	GND	40	NC
41	PCIE_mSATA_RXN_R	42	NC
43	PCIE_mSATA_RXP_R	44	NC
45	GND	46	NC
47	PCIE_mSATA_TXN_R	48	NC
49	PCIE_mSATA_TXP_R	50	M2M_PLTRSTN
51	GND	52	SRCCLKREQ7L
53	CLK_PCIE_M2M_N	54	I_WAKEN
55	CLK_PCIE_M2M_P	56	NC

Pin	Definition	Pin	Definition
57	GND	58	NC
59		60	
61		62	
63		64	
65		66	
67	NC	68	M2MSUSCLK
69	PCIE_mSATA_SEL	70	M2MKEYPWR
71	GND	72	M2MKEYPWR
73	GND	74	M2MKEYPWR
75	GND		

Mini PCIe Connector

Connector location: CN3

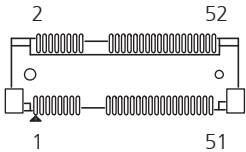

Pin	Definition	Pin	Definition
1	I_WAKEN	14	UIM_RESET
2	3VSBMINIPCIE	15	GND
3	N/A	16	UIM_VPP
4	GND	17	N/A
5	N/A	18	GND
6	1V5MINIPCIE	19	N/A
7	SRCCLKREQ2L_MINIPCIE	20	MINICARD2DIS#
8	UIM_PWR	21	GND
9	GND	22	MINIPCIEPERSTN
10	UIM_DATA	23	PCIE_mSATA_RXN_1R
11	CLK_PCIE_MINIPCIE_N	24	3VSBMINIPCIE
12	UIM_CLK	25	PCIE_mSATA_RXP_1R
13	CLK_PCIE_MINIPCIE_P	26	GND

Pin	Definition	Pin	Definition
27	GND	40	GND
28	1V5MINIPCIE	41	3VSBMINIPCIE
29	GND	42	N/A
30	SMB_CLK	43	GND
31	PCIE_mSATA_TXN_1R	44	N/A
32	SMB_DATA	45	N/A
33	PCIE_mSATA_TXP_1R	46	N/A
34	GND	47	N/A
35	GND	48	1V5MINIPCIE
36	USB2_DN7	49	N/A
37	GND	50	GND
38	USB2_DP7	51	PCIE_mSATA_SEL_1
39	3VSBMINIPCIE	52	3VSBMINIPCIE

USB Dongle Connector

Connector type: USB 2.0 Type A

Connector location: CN5

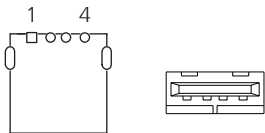

Pin	Definition
1	VCC5
2	USB2N_6_C
3	USB2P_6_C
4	GND

COM Port 1

Connector type: RS232/RS422/RS485

Connector location: COM1



Pin	Definition	Pin	Definition
1	COM1_DCDL	2	COM1_RXD
3	COM1_TXD	4	COM1_DTRL
5	GND	6	COM1_DSRL
7	COM1_RTSL	8	COM1_CTSL
9	COM1_RIL	10	GND

COM Port 2

Connector type: RS232/RS422/RS485

Connector location: COM2



Pin	Definition	Pin	Definition
1	COM2_DCDL	2	COM2_RXD
3	COM2_TXD	4	COM2_DTRL
5	GND	6	COM2_DSRL
7	COM2_RTSL	8	COM2_CTSL
9	COM2_RIL	10	GND

COM Port 3

Connector type: RS232

Connector location: COM3



Pin	Definition	Pin	Definition
1	COM3_DCDL	2	COM3_RXD
3	COM3_TXD	4	COM3_DTRL
5	GND	6	COM3_DSRL
7	COM3_RTSL	8	COM3_CTSL
9	COM3_RIL	10	GND

COM Port 4

Connector type: RS232

Connector location: COM4



Pin	Definition	Pin	Definition
1	COM4_DCDL	2	COM4_RXD
3	COM4_TXD	4	COM4_DTRL
5	GND	6	COM4_DSRL
7	COM4_RTSL	8	COM4_CTSL
9	COM4_RIL	10	GND

COM4_RS422 (Optional)

Connector type: RS232

Connector location: COM4_RS422



Pin	Definition	Pin	Definition
1	COM1_Z	2	COM1_Y
3	COM1_A	4	COM1_B
5	GND	6	NC
7	NC	8	NC
9	NC	10	GND

Fan Connectors

Connector location: FAN_CPU, FAN_SYS



FAN_CPU

Pin	Definition	Pin	Definition
1	GND	2	VCC12
3	FAN1TACH	4	FAN1PWM

FAN_SYS

Pin	Definition	Pin	Definition
1	GND	2	VCC12
3	FAN2TACH	4	FAN2PWM

BIOS FW Connector

Connector location: JFW1

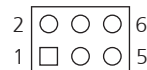

Pin	Definition
6	BIOSSPISI
5	BIOSSPISO
4	BIOSSPICKL
3	BIOSSPICSL0
2	GND
1	VSPI

GPIO Connector

Connector location: JP3

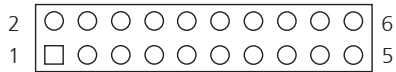

Pin	Definition	Pin	Definition
1	VCC5	2	VCC5
3	SGPI1	4	SGPO1
5	SGPI2	6	SGPO2
7	SGPI3	8	SGPO3
9	SGPI4	10	SGPO4
11	SGPI5	12	SGPO5
13	SGPI6	14	SGPO6
15	SGPI7	16	SGPO7
17	SGPI8	18	SGPO8
19	GND	20	GND

LED Connector

Connector location: JP5

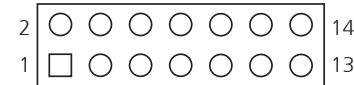

Pin	Definition	Pin	Definition
1	DIAG1_P	2	BAT_LOWL
3	LAN1_ACT#_LED_P	4	LAN1_LEDACTL
5	LAN2_ACT#_LED_P	6	LAN2_LEDACTL
7	LAN3_ACT#_LED_P	8	LAN3_LEDACTL
9	LAN4_ACT#_LED_P	10	LAN4_LEDACTL
11	SATALED#_P	12	I_SATALEDN
13	SGP33_P	14	S_GP33

SMBUS Connector

Connector location: JP6



Pin	Settings
1	SMB_CLK_C
2	SMB_DATA_C
3	GND

Power Module Connector

Connector location: JP10

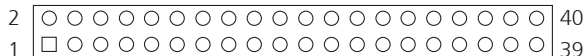

Pin	Definition	Pin	Definition
1	VIN_M	2	VIN_M
3	VIN_M	4	VIN_M
5	VIN_M	6	VIN_M
7	N/A	8	N/A
9	GND	10	GND
11	GND	12	GND
13	GND	14	GND
15	GND	16	GND
17	GND	18	GND
19	GND	20	GND

Pin	Definition	Pin	Definition
21	GND	22	GND
23	GND	24	GND
25	UART3_TXD	26	UART3_RXD_PM
27	I_SLPS3_N	28	PM_DETECTL
29	Remote_PBTPU	30	N/A
31	VCC12_PCIE	32	VCC12_PCIE
33	VCC12_PCIE	34	VCC12_PCIE
35	VCC12_PCIE	36	VCC12_PCIE
37	VCC12_PCIE	38	VCC12_PCIE
39	VCC12_PCIE	40	VCC12_PCIE

SMBUS Connector

Connector location: JP_PBT



Pin	Settings
1	PBT_PU
2	GND

Internal Connectors - Bottom Side

SIM Card Slot

Connector location: IDE1

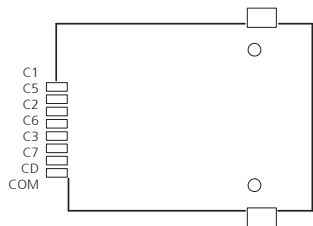

Pin	Definition	Pin	Definition
C1	UIM_PWR	C2	UIM_RESET
C3	UIM_CLK	C5	GND
C6	UIM_VPP	C7	UIM_DATA
MH1	GND	MH2	GND
SW1	GND	SW2	GND

SATA Power Connector

Connector location: CN7, CN8



Pin	Definition
1	VCC5
2	GND

PCIe X16 Slot

Connector location: PCIE1



Pin	Definition	Pin	Definition
A1	PCIE_PRSENT1	A2	VCC12_PCIE
A3	VCC12_PCIE	A4	GND
A5	PCIEX16_TCK	A6	PCIEX16_TDI
A7	PCIEX16_TDO	A8	PCIEX16_TMS
A9	VCC3	A10	VCC3
A11	I_PLTRSTN	A12	GND
A13	CLK_PCIEX16_SLOT_P	A14	CLK_PCIEX16_SLOT_N
A15	GND	A16	PEG_RXP0
A17	PEG_RXN0	A18	GND
A19	FAN_CTL2	A20	GND
A21	PEG_RXP1	A22	PEG_RXN1
A23	GND	A24	GND
A25	PEG_RXP2	A26	PEG_RXN2
A27	GND	A28	GND
A29	PEG_RXP3	A30	PEG_RXN3
A31	GND	A32	NC
A33	NC	A34	GND
A35	PEG_RXP4	A36	PEG_RXN4
A37	GND	A38	GND
A39	PEG_RXP5	A40	PEG_RXN5
A41	GND	A42	GND

Pin	Definition	Pin	Definition
A43	PEG_RXP6	A44	PEG_RXN6
A45	GND	A46	GND
A47	PEG_RXP7	A48	PEG_RXN7
A49	GND	A50	NC
A51	GND	A52	PEG_RXP8
A53	PEG_RXN8	A54	GND
A55	GND	A56	PEG_RXP9
A57	PEG_RXN9	A58	GND
A59	GND	A60	PEG_RXP10
A61	PEG_RXP10	A62	GND
A63	GND	A64	PEG_RXP11
A65	PEG_RXN11	A66	GND
A67	GND	A68	PEG_RXP12
A69	PEG_RXN12	A70	GND
A71	GND	A72	PEG_RXP13
A73	PEG_RXN13	A74	GND
A75	GND	A76	PEG_RXP14
A77	PEG_RXN14	A78	GND
A79	GND	A80	PEG_RXP15
A81	PEG_RXN15	A82	GND

Continued on next page

Pin	Definition	Pin	Definition
B1	VCC12_PCIE	B2	VCC12_PCIE
B3	VCC12_PCIE	B4	GND
B5	SMB_CLK	B6	SMB_DAT
B7	GND	B8	VCC3
B9	PCIEX16_TRST#	B10	3VSB
B11	I_WAKEN	B12	FAN_TAC2
B13	GND	B14	PEG_TXP0_C
B15	PEG_TXN0_C	B16	GND
B17	PRSNT2#_1	B18	GND
B19	PEG_TXP1_C	B20	PEG_TXN1_C
B21	GND	B22	GND
B23	PEG_TXP2_C	B24	PEG_TXN2_C
B25	GND	B26	GND
B27	PEG_TXP3_C	B28	PEG_TXN3_C
B29	GND	B30	NC
B31	PRSNT2#_2	B32	GND
B33	PEG_TXP4_C	B34	PEG_TXN4_C
B35	GND	B36	GND
B37	PEG_TXP5_C	B38	PEG_TXN5_C
B39	GND	B40	GND
B41	PEG_TXP6_C	B42	PEG_TXN6_C

Pin	Definition	Pin	Definition
B43	GND	B44	GND
B45	PEG_TXP7_C	B46	PEG_TXN7_C
B47	GND	B48	PRSNT2#_3
B49	GND	B50	PEG_TXP8_C
B51	PEG_TXN8_C	B52	GND
B53	GND	B54	PEG_TXP9_C
B55	PEG_TXN9_C	B56	GND
B57	GND	B58	PEG_TXP10_C
B59	PEG_TXN10_C	B60	GND
B61	GND	B62	PEG_TXP11_C
B63	PEG_TXN11_C	B64	GND
B65	GND	B66	PEG_TXP12_C
B67	PEG_TXN12_C	B68	GND
B69	GND	B70	PEG_TXP13_C
B71	PEG_TXN13_C	B72	GND
B73	GND	B74	PEG_TXP14_C
B75	PEG_TXN14_C	B76	GND
B77	GND	B78	PEG_TXP15_C
B79	PEG_TXN15_C	B80	GND
B81	PRSNT2#_4	B82	NC

SATA Connectors

Connector location: SATA1, SATA2

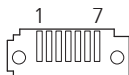

SATA1

Pin	Definition	Pin	Definition
1	GND	2	SATA_TXP2
3	SATA_TXN2	4	GND
5	SATA_RXN2	6	SATA_RXP2
7	GND		

SATA2

Pin	Definition	Pin	Definition
1	GND	2	SATA_TXP3
3	SATA_TXN3	4	GND
5	SATA_RXN3	6	SATA_RXP3
7	GND		

CHAPTER 3: SYSTEM SETUP

Removing the Top Cover



Prior to removing the chassis cover, make sure the unit's power is off and disconnected from the power sources to prevent electric shock or system damage.

1. Remove the 4 screws on the sides.



2. Remove the 4 screws on the top.

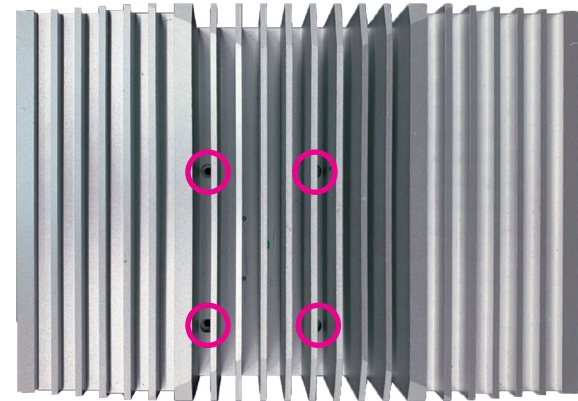

3. With the screws removed, lift up the cover and remove it from the chassis.
4. When reinstalling the top cover to the system, ensure that the 4 mounting holes on the top cover is aligned correctly to the four copper standoffs around the CPU socket.

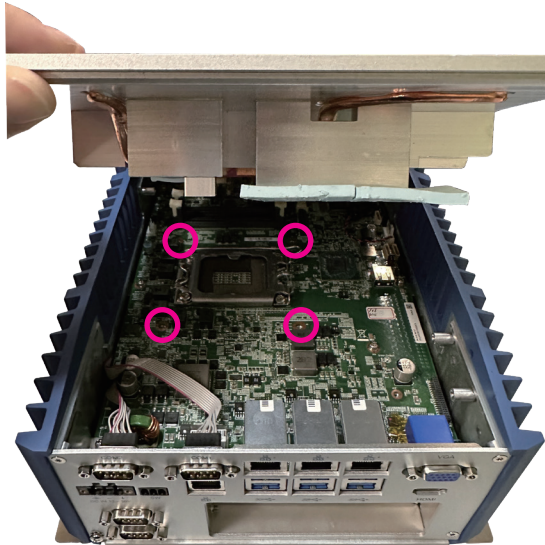

Removing the Bottom Cover

1. Locate the 6 screws on the bottom cover.

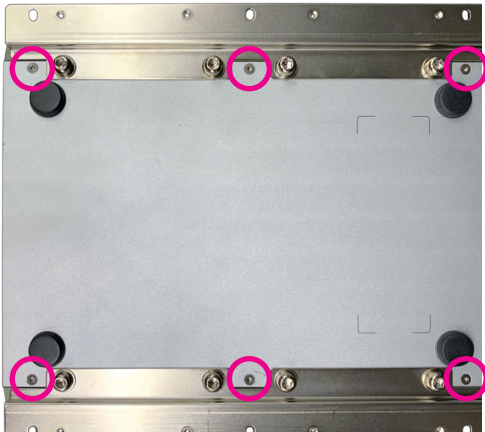

2. Remove the screws, then lift up the bottom cover and remove it from the chassis.

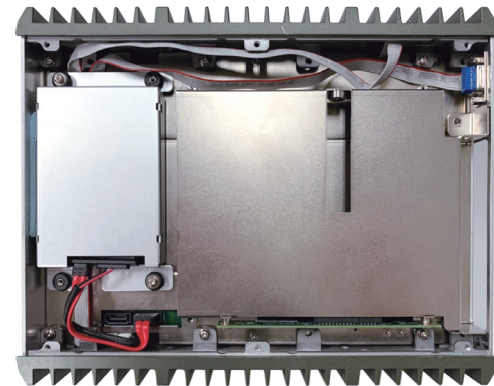

Installing a CPU

1. Locate the CPU socket on the board. Unlock the socket by pushing the load lever down, moving it sideways until it is released from the retention tab.
2. Lift the load lever up to open the CPU retention bracket.

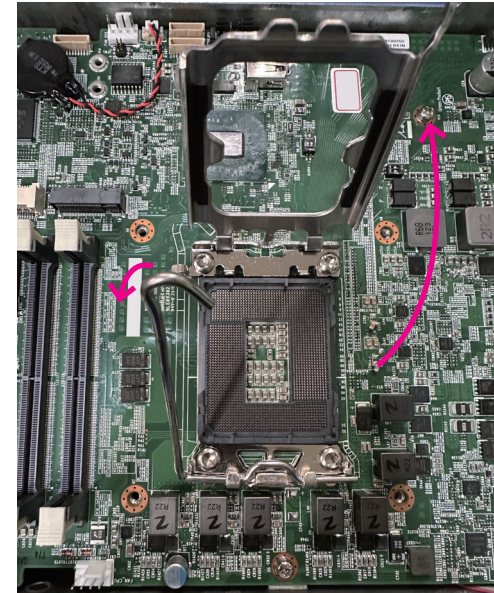
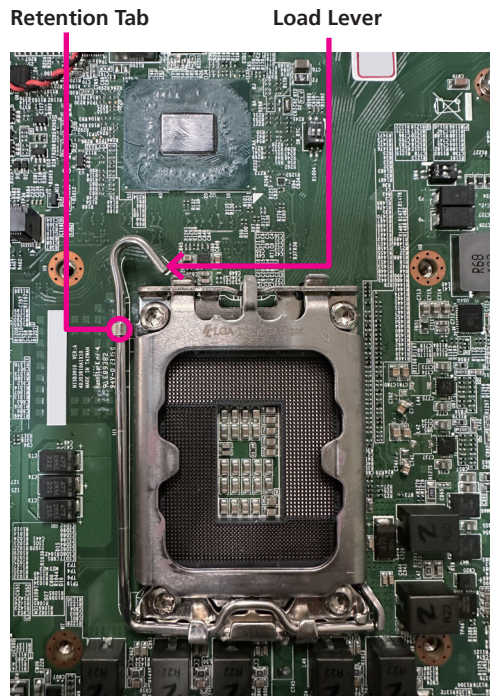

3. Insert the CPU into the socket. The triangular edge on the CPU must align with the corner of the CPU socket shown on the photo.

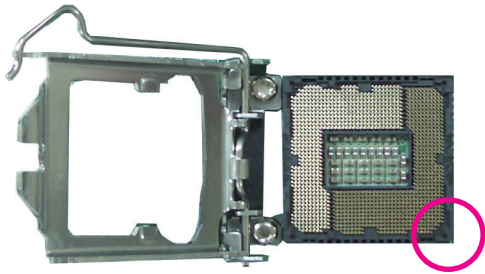

The CPU's notch will at the same time fit into the socket's alignment key.

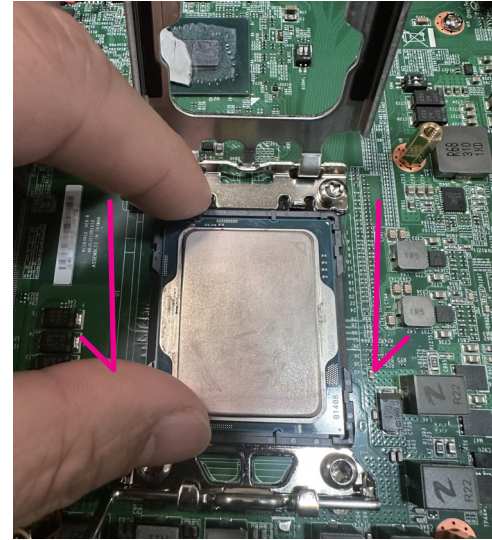
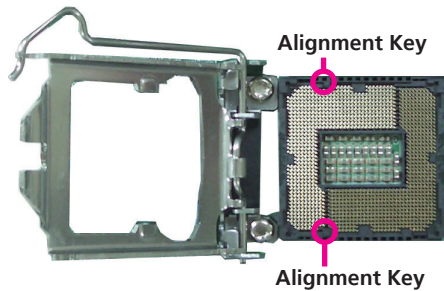

- Handle the CPU by its edges and avoid touching the pins.
- The CPU will fit in only one orientation and can easily be inserted without exerting any force.

4. Close the load plate and then hook the load lever under the retention.

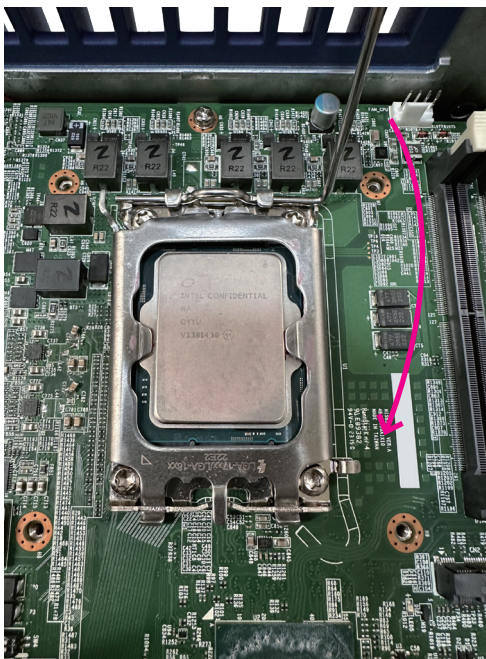

Do not force the CPU into the socket. Forcing the CPU into the socket may bend the pins and damage the CPU.

Installing a SO-DIMM Memory Module

1. Locate the SO-DIMM sockets and release the locks.

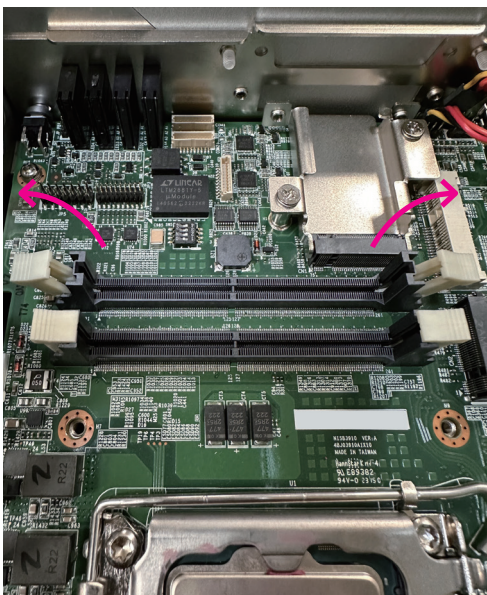

2. Insert the SO-DIMM module into the socket and apply even pressure to both ends of the module until it slips into the socket. While pushing the module into position, the locks will close automatically.



3. Repeat steps 1 and 2 to install the second memory module if you wish to add more memory.

Installing a Mini-PCIe Module

1. Locate the mini-PCIe slot on the board.
2. Insert a mini-PCIe module into the slot at a 45-degree angle until the gold-plated connector on the edge of the module completely disappears inside the slot.
3. Push the module down and tighten a screw into the mounting hole on the module to secure it.

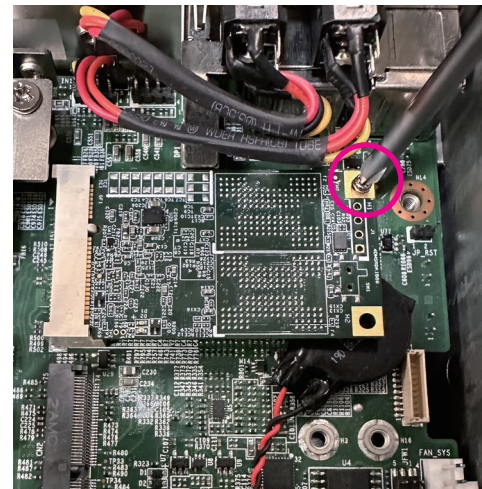
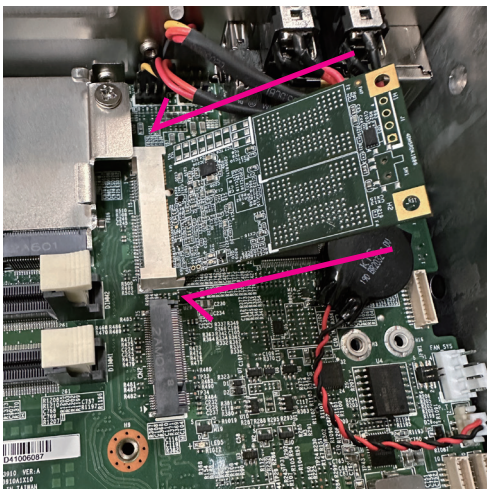

4. Attach the heatsink which has double-sided tape applied onto the M.2 card.

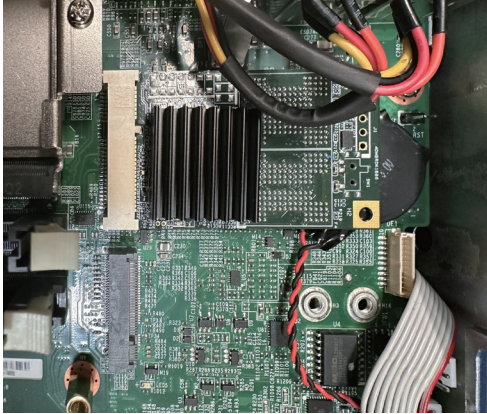

Installing a SIM Card

1. The SIM card is located on the front panel and covered with a panel. To insert the SIM card, refer to the image below to loosen the screws.
2. Place the SIM card directly into the card slot. To remove the SIM card, gently push on its bottom edge.

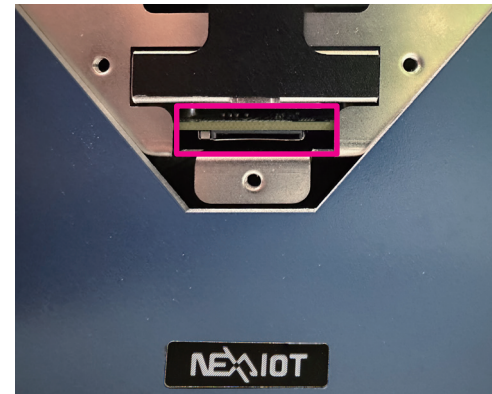

Installing an M.2 Module (External)

1. The external M.2 slot is located on the front panel and covered with a panel. To insert an M.2 module, refer to the image below to loosen the screws.



2. Follow the location indicated below to pull out the M.2 bracket.

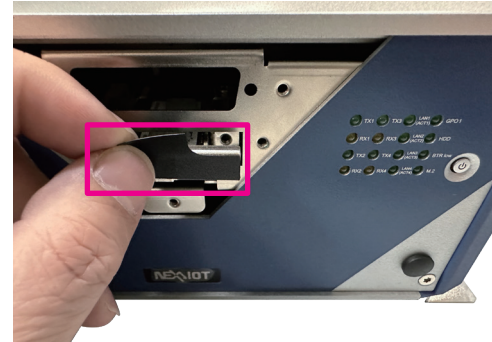

- Stick thermal pad (P/N:5060200111X00) onto the M.2 bracket, and stick ceramic thermal pads (P/N: 5044440181X00) onto the chipsets of the M.2 module respectively
- Slide the M.2 module onto the mounting plate of the M.2 bracket, and secure it with a screw.

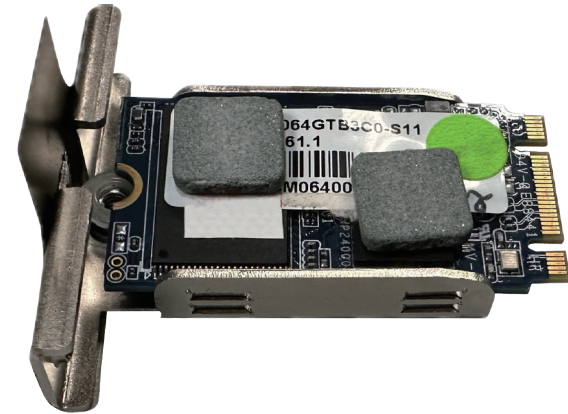
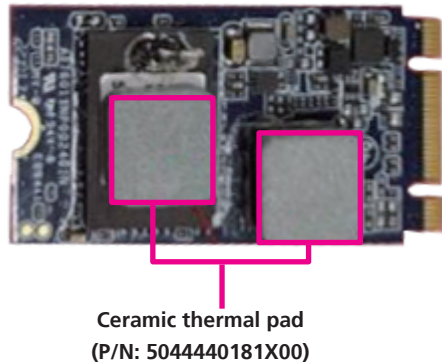
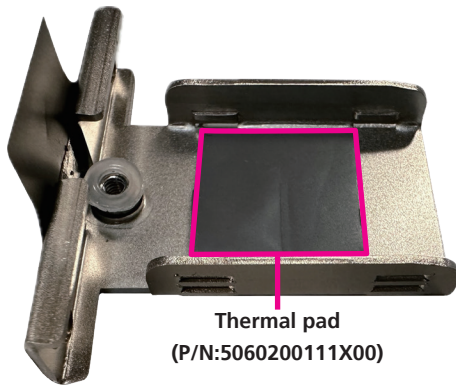

- Install the M.2 bracket back to its original position. Make sure the connector on the edge of the module is plugged firmly into the connector on the board.

Installing an M.2 Module (Internal)

1. Locate the M.2 slot on the board.
2. Insert the M.2 module into the slot at a 30-degree angle until the gold-plated connector on the edge of the module completely disappears inside the slot. Push the module down and then secure it with a mounting screw.

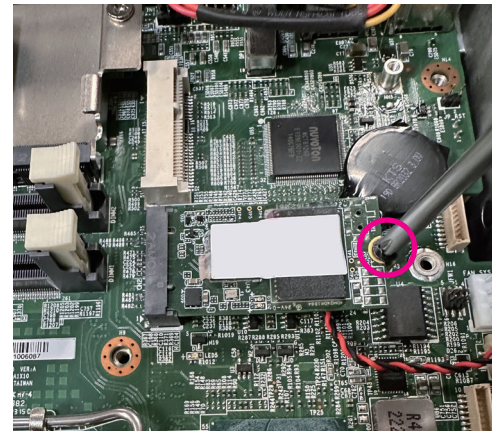
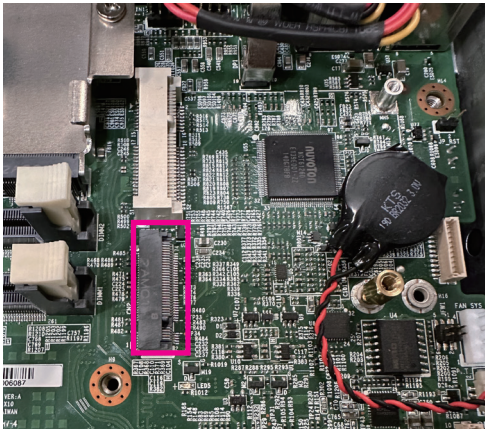

Installing an Internal SATA Storage Drive (NISE 3910E/E16/E2/P2/P2E)

1. With the bottom cover of the chassis removed, loosen the screws securing the storage bracket, and lift it up.
2. Place the storage drive into the bracket and secure the drive with screws.

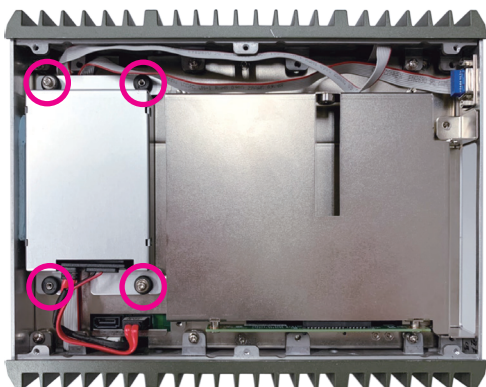

3. Plug the SATA connector into the storage drive and secure the storage bracket back to its original location. If the SATA power and data cables are higher than the chassis, please rearrange the cables so that they are inside the chassis, as shown by the dotted line below.

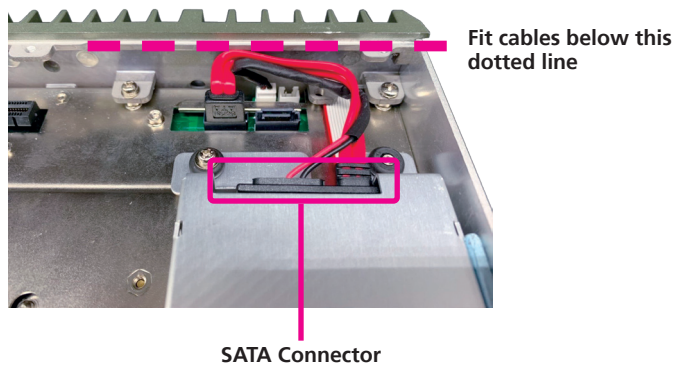

Installing an Internal SATA Storage Drive (NISE 3910R)

1. On the rear panel of NISE 3910R, loosen the screws on the SSD/HDD drive bay, then hold the drive bay handle to pull it out.
2. Insert the storage drive into the drive bay with the SATA data and power connector facing towards the end. Then, while supporting the storage drive, turn the bracket to the other side. From the outside of the storage bracket, secure the drive in place with screws.

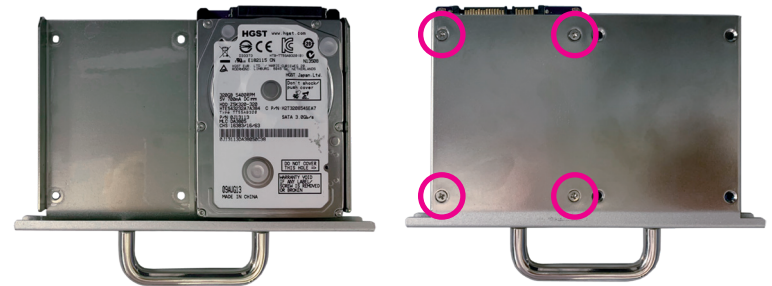

3. Insert the drive bay back in the SSD/HDD slot and tighten the screws to secure it in place.

Wallmount Brackets

The wallmount brackets provide a convenient and economical way of mounting the system on the wall.

1. The mounting holes are located at the bottom of the system. Secure the brackets on each side of the system using the provided mounting screws (M6*10mm).

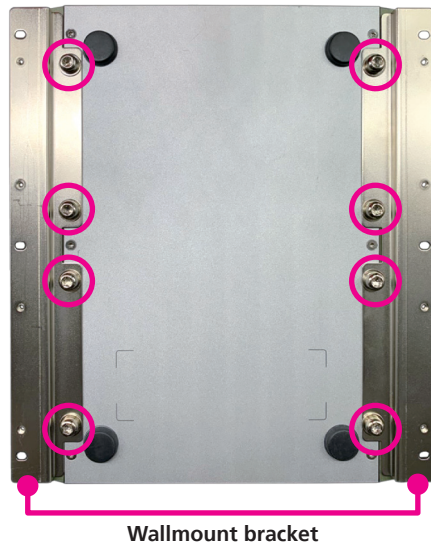

2. Secure the system to the wall by fastening screws through the mounting holes of the bracket.

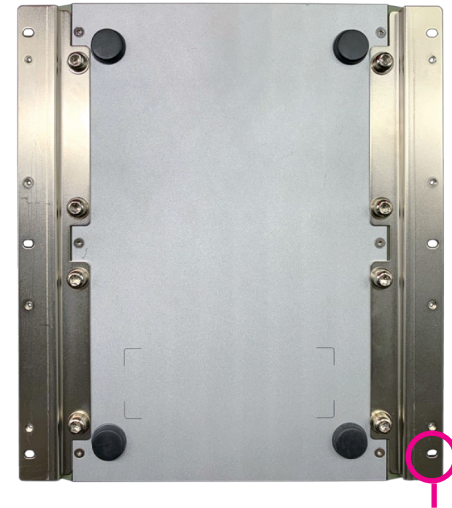

Fasten screws to mount the system to the wall

CHAPTER 4: BIOS SETUP

This chapter describes how to use the BIOS setup program for the NISE 3910 series. The BIOS screens provided in this chapter are for reference only and may change if the BIOS is updated in the future.

To check for the latest updates and revisions, visit the NexAIoT website at www.nexaiot.com.

About BIOS Setup

The BIOS (Basic Input and Output System) Setup program is a menu driven utility that enables you to make changes to the system configuration and tailor your system to suit your individual work needs. It is a ROM-based configuration utility that displays the system's configuration status and provides you with a tool to set system parameters.

These parameters are stored in non-volatile battery-backed-up CMOS RAM that saves this information even when the power is turned off. When the system is turned back on, the system is configured with the values found in CMOS.

With easy-to-use pull down menus, you can configure such items as:

- Hard drives, diskette drives, and peripherals
- Video display type and display options
- Password protection from unauthorized use
- Power management features

The settings made in the setup program affect how the computer performs. It is important, therefore, first to try to understand all the setup options, and second, to make settings appropriate for the way you use the computer.

When to Configure the BIOS

- This program should be executed under the following conditions:
 - When changing the system configuration
 - When a configuration error is detected by the system and you are prompted to make changes to the setup program
 - When resetting the system clock
 - When redefining the communication ports to prevent any conflicts
 - When making changes to the Power Management configuration
 - When changing the password or making other changes to the security setup

Normally, CMOS setup is needed when the system hardware is not consistent with the information contained in the CMOS RAM, whenever the CMOS RAM has lost power, or the system features need to be changed.

Default Configuration

Most of the configuration settings are either predefined according to the Load Optimal Defaults settings which are stored in the BIOS or are automatically detected and configured without requiring any actions. There are a few settings that you may need to change depending on your system configuration.

Entering Setup











When the system is powered on, the BIOS will enter the Power-On Self Test (POST) routines. These routines perform various diagnostic checks; if an error is encountered, the error will be reported in one of two different ways:

- If the error occurs before the display device is initialized, a series of beeps will be transmitted.
- If the error occurs after the display device is initialized, the screen will display the error message.

Powering on the computer and immediately pressing allows you to enter Setup.

Press the  key to enter Setup:

Legends

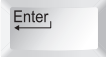
Key	Function
	Moves the highlight left or right to select a menu.
	Moves the highlight up or down between sub-menus or fields.
	Exits the BIOS Setup Utility.
	Scrolls forward through the values or options of the highlighted field.
	Scrolls backward through the values or options of the highlighted field.
	Selects a field.
	Displays General Help.
	Load previous values.
	Load optimized default values.
	Saves and exits the Setup program.
	Press <Enter> to enter the highlighted sub-menu.

Scroll Bar

When a scroll bar appears to the right of the setup screen, it indicates that there are more available fields not shown on the screen. Use the up and down arrow keys to scroll through all the available fields.

Submenu

When “▶” appears on the left of a particular field, it indicates that a submenu which contains additional options are available for that field. To display the submenu, move the highlight to that field and press  .

BIOS Setup Utility

Once you enter the AMI BIOS Setup Utility, the Main Menu will appear on the screen. The main menu allows you to select from several setup functions and one exit. Use arrow keys to select among the items and press  to accept or enter the submenu.

Main

The Main menu is the first screen that you will see when you enter the BIOS Setup Utility.

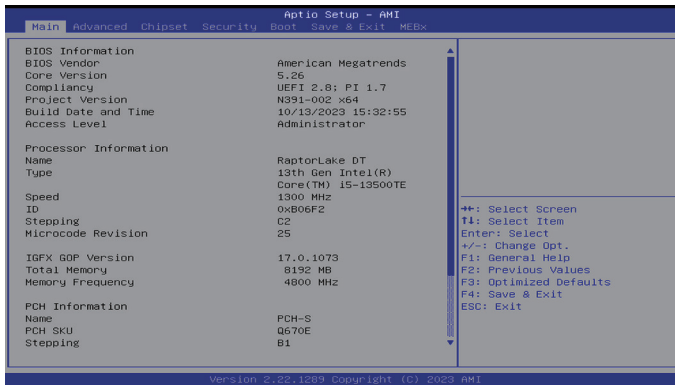

System Language

Selects the language of the system.

System Date

The date format is <day>, <month>, <date>, <year>. Day displays a day, from Monday to Sunday. Month displays the month, from January to December. Date displays the date, from 1 to 31. Year displays the year, from 1999 to 2099.

System Time

The time format is <hour>, <minute>, <second>. The time is based on the 24-hour military-time clock. For example, 1 p.m. is 13:00:00. Hour displays hours from 00 to 23. Minute displays minutes from 00 to 59. Second displays seconds from 00 to 59.

Advanced

The Advanced menu allows you to configure your system for basic operation. Some entries are defaults required by the system board, while others, if enabled, will improve the performance of your system or let you set some features according to your preference.



Setting incorrect field values may cause the system to malfunction.

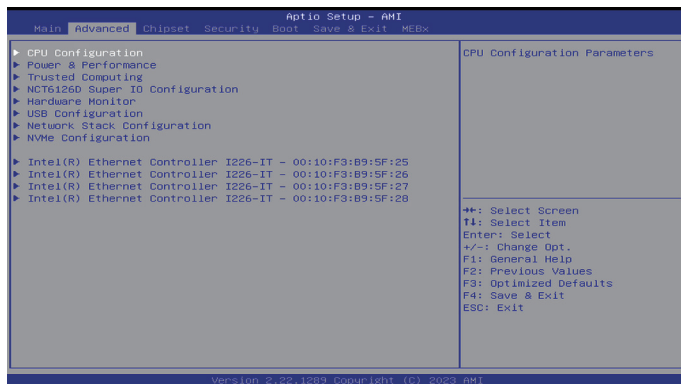

CPU Configuration

This section is used to configure the CPU.



Intel (VMX) Virtualization Technology

Enable or disable Intel Virtualization technology.

Active Processors Cores

Select the number of cores to enable in each processor package.

Hyper-Threading

Enable or disable hyper-threading technology.

Power & Performance

This section is used to configure the CPU power management features.

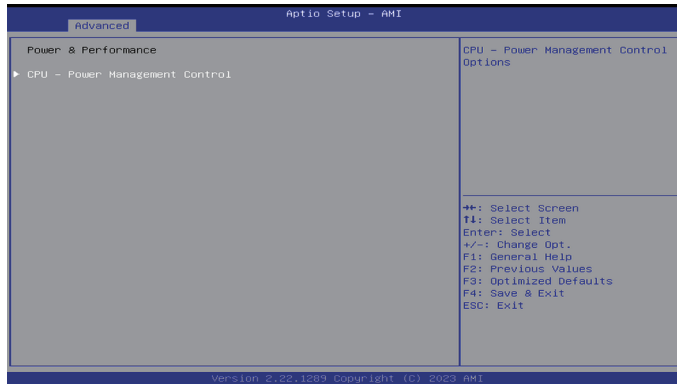

CPU - Power Management Control

Enter the CPU - Power Management Control submenu.

CPU - Power Management Control

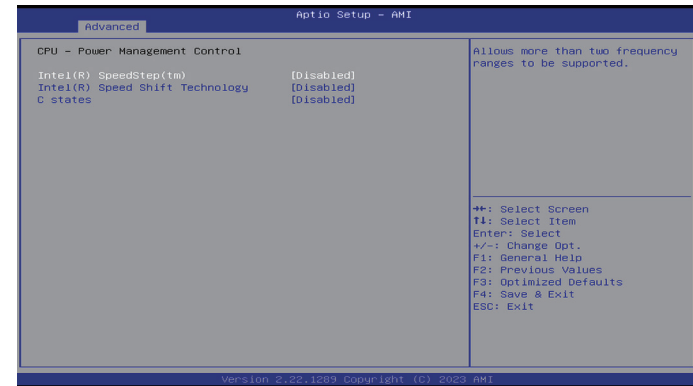

Intel(R) SpeedStep(tm)

Enable or disable Intel SpeedStep technology.

Intel(R) Speed Shift Technology

Enable or disable Intel Speed Shift Technology support. Enabling it will expose the CPPC v2 interface to allow hardware controlled P-states.

C states

Enable or disable CPU C states support for power saving.

Trusted Computing

This section is used to configure Trusted Platform Module (TPM) settings.

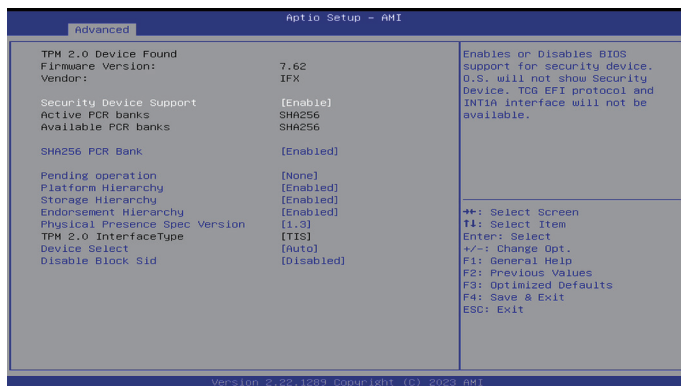

Security Device Support

Enable or disable BIOS support for security device. O.S will not show Security Device. TCG EFI protocol and INT1A interface will not be available.

SHA256 PCR Bank

Enable or disable SHA256 PCR Bank.

Pending operation

Schedule an operation for the security device.

Platform Hierarchy

Enable or disable platform hierarchy.

Storage Hierarchy

Enable or disable storage hierarchy.

Endorsement Hierarchy

Enable or disable endorsement hierarchy.

Physical Presence Spec Version

Configure the physical presence spec version.

Device Select

Configure the TPM version. TPM 1.2 will restrict support to TPM 1.2 devices and TPM 2.0 will restrict support to TPM 2.0 devices. Auto will support both TPM 1.2 and 2.0 devices with the default set to TPM 2.0 devices if not found, and TPM 1.2 devices will be enumerated.

Disable Block Sid

Override to allow SID authentication in TCG storage device.

NCT6126D Super IO Configuration

This section is used to configure the serial ports.

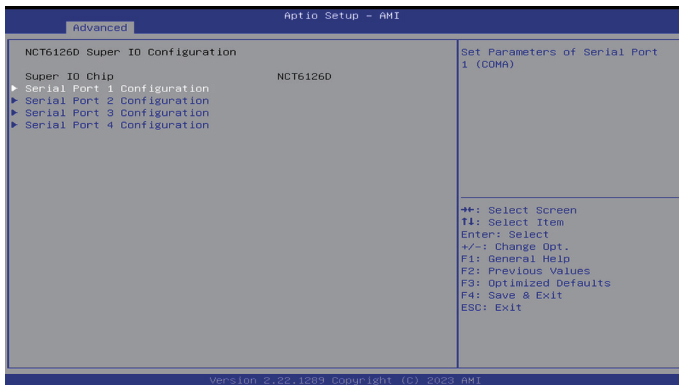

Serial Port 1/2/3/4 Configuration

This section is used to configure serial port 1/2/3/4.

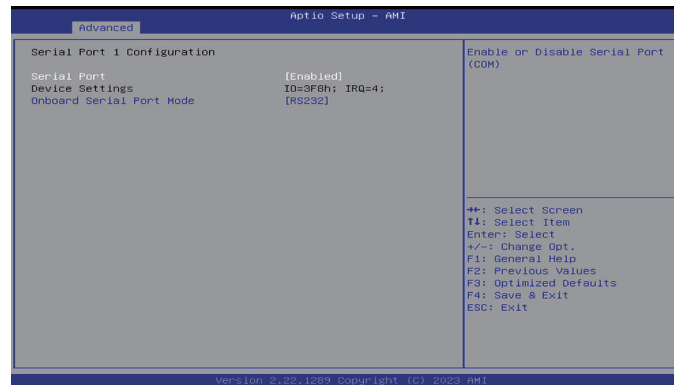

Serial Port 1/2/3/4 Configuration

Enter the Serial Port 1/2/3/4 Configuration submenu.

Serial Port 1/2/3/4

Enable or disable the serial port.

Onboard Serial Port Mode 1/2

Select this to change the serial port mode to RS232, RS422, or RS485.

Hardware Monitor

This section is used to monitor hardware status such as temperature, fan speed, and voltages.

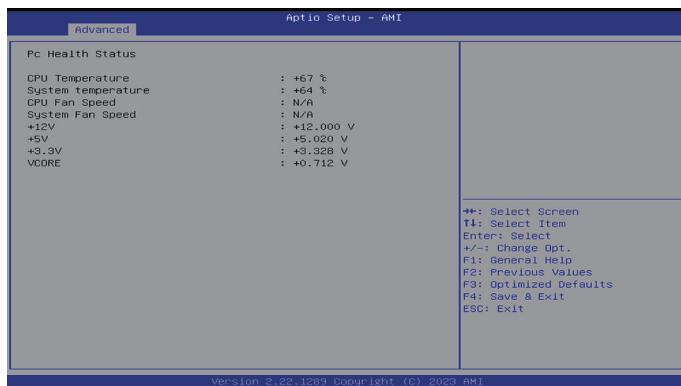

USB Configuration

This section is used to configure the USB.

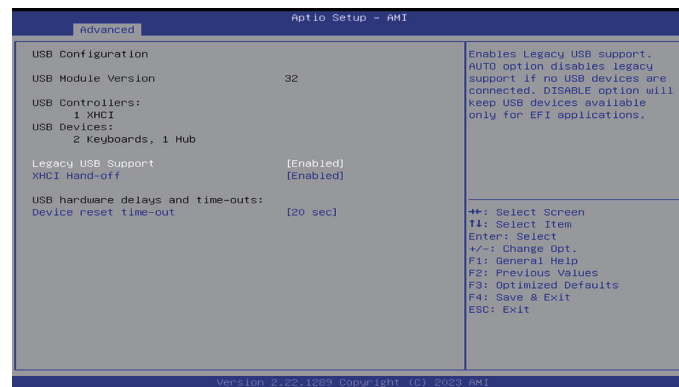

Legacy USB Support

Enabled Enables Legacy USB.
 Auto Disables support for Legacy when no USB devices are connected.
 Disabled Keeps USB devices available only for EFI applications.

XHCI Hand-off

This is a workaround for OSs that does not support XHCI hand-off. The XHCI ownership change should be claimed by the XHCI driver.

Device reset time-out

Selects the USB mass storage device's start unit command timeout.

Network Stack Configuration

This section is used to configure the network stack.

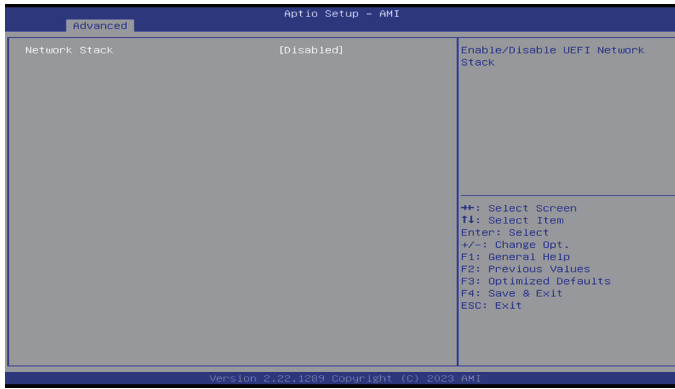

Network Stack

Enable or disable UEFI network stack.

NVMe Configuration

This section is used to configure the NVMe devices installed.



NVMe Configuration

See the detailed information of installed NVMe device.

Intel(R) Ethernet Controller I226-IT

This section is used to display information of the Intel Ethernet controller.

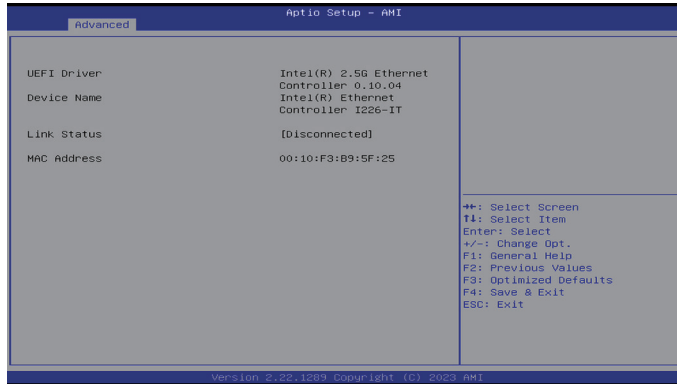

Chipset

This section gives you functions to configure the system based on the specific features of the chipset. The chipset manages bus speeds and access to system memory resources.

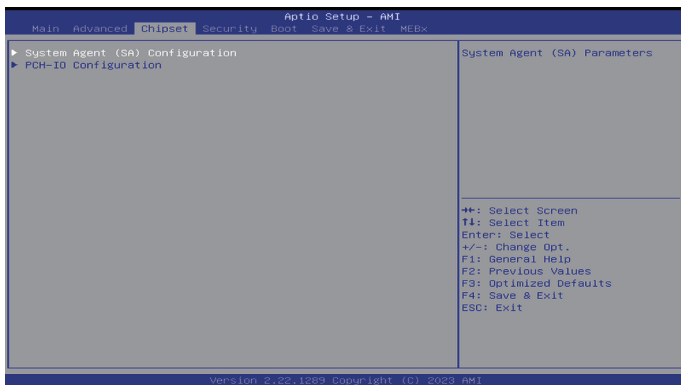

System Agent (SA) Configuration

Configure the System Agent (SA) parameters.

PCH-IO Configuration

Configure the PCH-IO parameters.

System Agent (SA) Configuration

This section is used to configure the System Agent (SA) configuration.

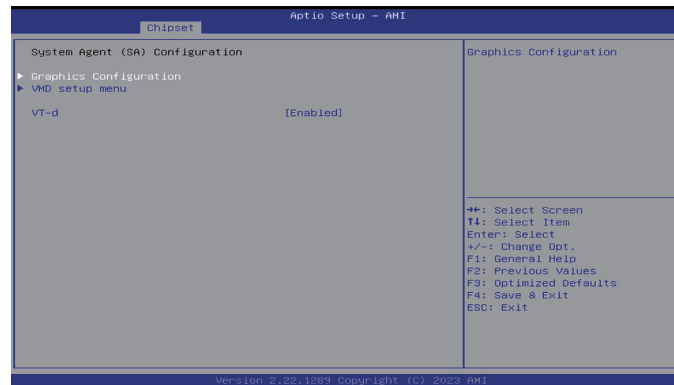

Graphic Configuration

Enter the Graphic Configuration submenu.

VMD setup menu

Enter the VMD setup menu submenu.

VT-d

Enable or disable VT-d capability.

Graphic Configuration

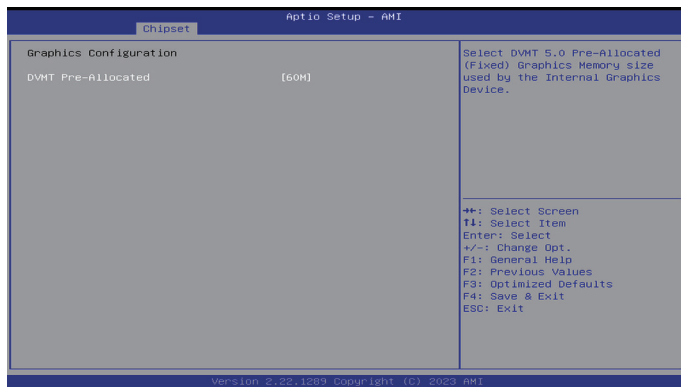

DVMT Pre-Allocated

Select DVMT 5.0 Pre-Allocated (Fixed) graphic memory size used by the internal graphic device.

VMD Configuration

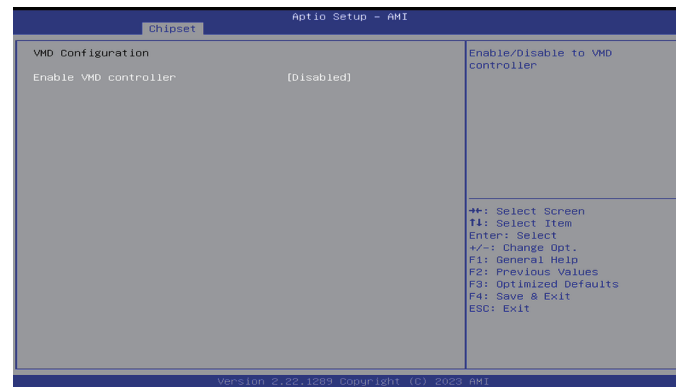

Enable VMD controller

Enable or disable the VMD controller.

PCH-IO Configuration

This section is used to configure PCH-IO configuration.

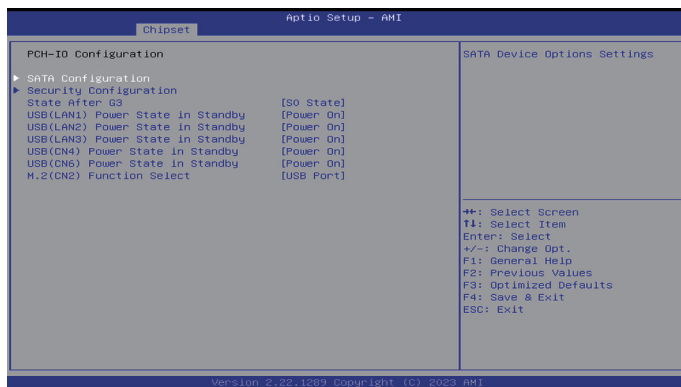

SATA Configuration

Enter the SATA Configuration sub-menu.

Security Configuration

Enter the Security Configuration sub-menu.

State After G3

Specify what state to go to when power is re-applied after a power failure (G3 state).

USB (LAN1/LAN2/LAN3/CN4/CN6) Power State in Standby

Select USB(LAN1/LAN2/LAN3/CN4/CN6) power state in standby mode.

M.2 (CN2) Function Select

Select PCIe+USB3.

SATA Configuration

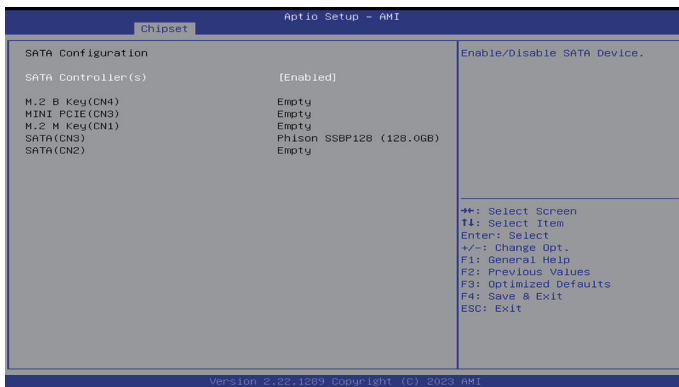

SATA Controller(s)

Enable or disable SATA device.

Security Configuration

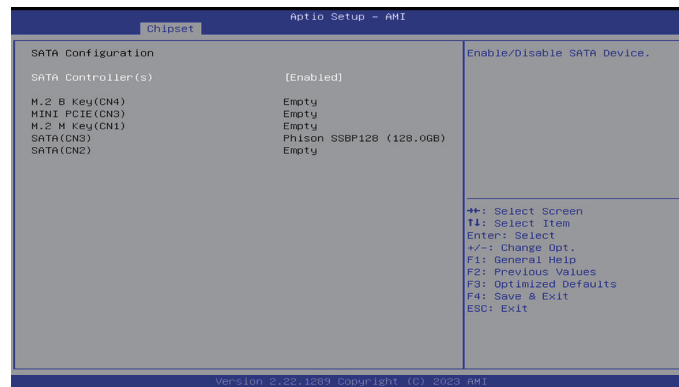

RTC Memory Lock

Enable will lock bytes 38h-3Fh in the lower/upper 128-byte bank of RTC RAM.

Security

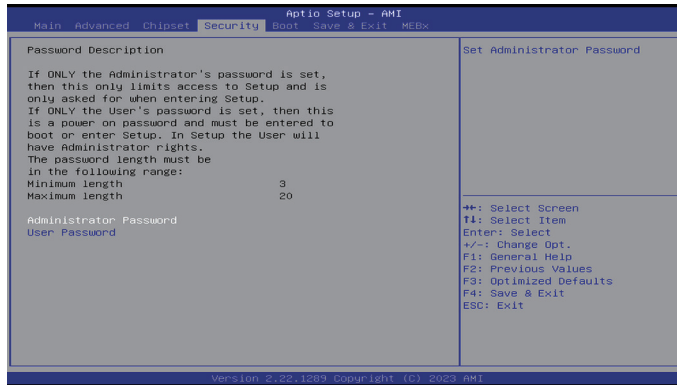

Administrator Password

Select this to reconfigure the administrator's password.

User Password

Select this to reconfigure the user's password.

Boot

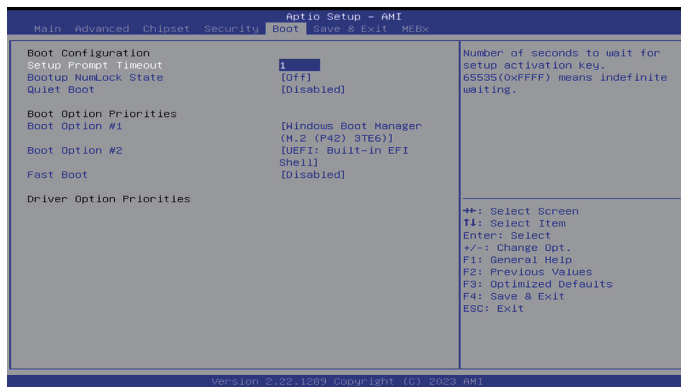

Setup Prompt Timeout

Select the number of seconds to wait for the setup activation key. 65535(0xFFFF) denotes indefinite waiting.

Bootup NumLock State

This allows you to determine the default state of the numeric keypad. By default, the system boots up with NumLock on wherein the function of the numeric keypad is the number keys. When set to Off, the function of the numeric keypad is the arrow keys.

Quiet Boot

Enabled Displays OEM logo instead of the POST messages.
 Disabled Displays normal POST messages.

Boot Option Priorities

Adjust the boot sequence of the system. Boot Option #1 is the first boot device that the system will boot from, next will be #2 and so forth.

Fast Boot

Enable or disables boot with initialization of a minimal set of devices required to launch active boot option. Has no effect for BBS boot options.

Save & Exit

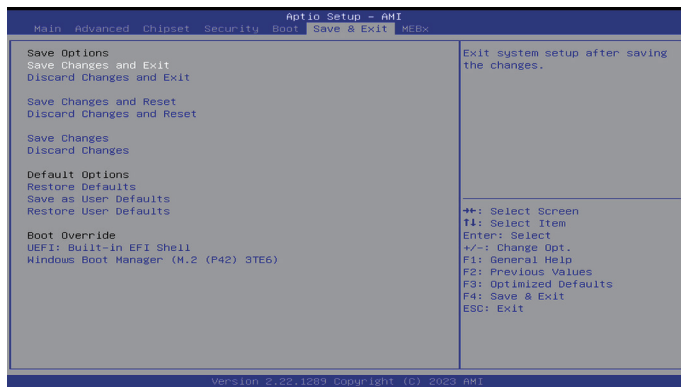

Save Changes and Exit

To save the changes and exit the Setup utility, select this field then press <Enter>. A dialog box will appear. Confirm by selecting Yes. You can also press <F4> to save and exit Setup.

Discard Changes and Exit

To exit the Setup utility without saving the changes, select this field then press <Enter>. You may be prompted to confirm again before exiting. You can also press <ESC> to exit without saving the changes.

Save Changes and Reset

To save the changes and reset, select this field then press <Enter>. A dialog box will appear. Confirm by selecting Yes.

Discard Changes and Reset

To exit the Setup utility and reset without saving the changes, select this field then press <Enter>. You may be prompted to confirm again before exiting.

Save Changes

To save changes and continue configuring the BIOS, select this field then press <Enter>. A dialog box will appear. Confirm by selecting Yes.

Discard Changes

To discard the changes, select this field then press <Enter>. A dialog box will appear. Confirm by selecting Yes to discard all changes made and restore the previously saved settings.

Restore Defaults

To restore the BIOS to default settings, select this field then press <Enter>. A dialog box will appear. Confirm by selecting Yes.

Save as User Defaults

To use the current configurations as user default settings for the BIOS, select this field then press <Enter>. A dialog box will appear. Confirm by selecting Yes.

Restore User Defaults

To restore the BIOS to user default settings, select this field then press <Enter>. A dialog box will appear. Confirm by selecting Yes.

Boot Override

To bypass the boot sequence from the Boot Option List and boot from a particular device, select the desired device and press <Enter>.

MEBx

This MEBx menu is allowed you to view and changed the MEBx congfiguration.

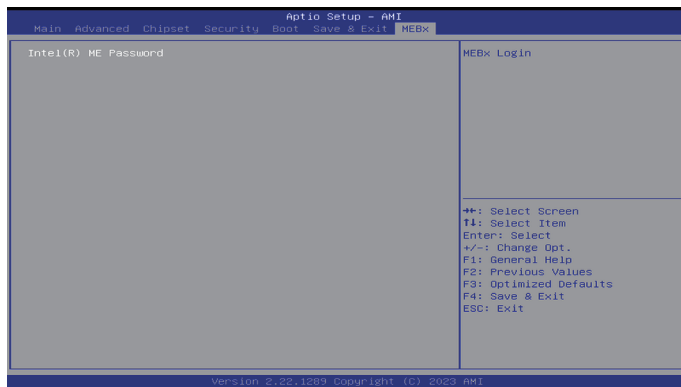

Intel(R) ME Password

MEBx Login and configure AMT BIOS features.