CANopen Slave Device

CAN-2084C

Application User's Manual

Warranty

All products manufactured by ICP DAS are under warranty regarding defective materials for a period of one year from the date of delivery to the original purchaser.

Warning

ICP DAS assumes no liability for damages resulting from the use of this product. ICP DAS reserves the right to change this manual at any time without notice. The information furnished by ICP DAS is believed to be accurate and reliable. However, no responsibility is assumed by ICP DAS for its use, or for any infringements of patents or other rights of third parties resulting from its use.

Copyright

Copyright ©2019 is reserved by ICP DAS.

Trademark

The names used for identification only may be registered trademarks of their respective companies.

Table of Contents

1.	Introduction	3
1.1	Overview	3
1.2	Features	5
1.3	Hardware Specifications	5
1.4	Application	7
2.	Hardware.....	8
2.1	Structure.....	8
2.2	Node ID & Baud Rate Rotary Switch.....	9
2.3	LED Description.....	10
2.4	PIN Assignment	11
2.5	Wire Connection	12
2.6	Input Signal Model.....	13
2.7	Digital Low Pass Filter	14
2.8	Counter Mode	16
2.8.1	Mode 0: Dir/Pulse Counting.....	16
2.8.2	Mode 1: Up/Down Counting.....	16
2.8.3	Mode 2: Frequency Mode	17
2.8.4	Mode 3: Up Counting.....	18
2.8.5	Mode 4: Quadrant Counting	18
3.	Application.....	19
3.1	Object Dictionary	19
3.2	Store and Restore Object.....	25
3.3	Application Object.....	26
3.4	Default PDO Mapping.....	33
3.5	EMCY Communication	34

1. Introduction

1.1 Overview

CANopen is one kind of the network protocols based on CAN bus and mainly used for embedded system, such as industrial machine control, vehicle control system, factory automation, medical equipments control, remote data acquisition, environment monitoring and package machines control. The CAN-2084C is a CANopen slave which follows the CiA 301 version 4.02. The CAN-2084C is a 4/8-channel Counter/Frequency module that provides “Up Counter”, “Frequency”, “Up/Down Counter”, “Dir/Pulse Counter” and “A/B Phase Counter” modes. It provides a variety of measurement applications, such as measuring a number of time-related quantities, counting events or totalizing and monitoring position with quadrature encoders. In addition, a digital filter is used to eliminate the effects of noise. Users can obtain those data or configure the CAN-2084C via the standard CANopen protocol. In order to be fully compatible with other CANopen devices, the CAN-2084C has passed the validation of the CiA CANopen Conformance Test tool. Therefore, it is very easy to integrate the CAN-2084C with the standard CANopen master by applying the EDS file. Combining with the CANopen masters of ICP DAS, you can quickly build a CANopen network to approach your requirements.

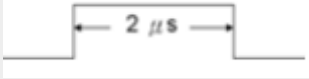

Figure 1-1 CAN-2084C

1.2 Features

- NMT Slave
- Guarding or Heartbeat Error Control protocols
- Supports Dynamic PDO
- Provide the EDS file
- ESD Protection 4 KV Contact for each channel
- Verifies by the CiA CANopen Conformance Test tool

1.3 Hardware Specifications

CANopen Interface	
Connector	5-pin screwed terminal block (CAN_GND, CAN_L, CAN_SHLD, CAN_H, CAN_V+)
Baud Rate (bps)	10 k, 20 k, 50 k, 125 k, 250 k, 500 k, 800 k, 1 M, selected by rotary switch
Terminator Resistor	DIP switch for the 120 Ω terminator resistor
Protocol	CANopen CiA 301 ver4.02, CiA 401 ver2.1
Node ID	1~99 selected by rotary switch
NMT	Slave
Error Control	Node Guarding protocol / Heartbeat Producer
SDOs	1 server, 0 client
PDOs	10 RxPDO, 10 TxPDO (Supports dynamic PDO)
PDO Modes	Event-triggered, remotely-requested, synchronous (cyclic), synchronous (acyclic)
Emergency Message	Yes
EDS file	Yes
Digital Input	
Mode	4-channel Up/Down Counter (Up/Down) 4-channel Dir/Pulse Counter (Bi-direction) 4-channel Quadrant Counting 8-channel Up Counter 8-channel Frequency Programmable Digital Noise Filter: 1 to 32767 μ s
Isolated Input Level	Logic Level 0: +1 V Max. Logic Level 1: +4.5 to +30 V
TTL Input Level	Logic Level 0: 0 to +0.8 V Logic Level 1: 2 to +5 V
Minimum Pulse Width	2 μ s 
Input Frequency	1 Hz ~ (typically) 250 kHz for both counter and frequency mode, where 250 kHz is calculated as follows: supposed that the duty cycle = 50%, by referring to the Minimum Pulse Duration of the High Level, the pulse period will be 2 μ s x 2 = 4 μ s, which is 250 kHz as a maximum. Maximum Frequency: Refer to the Minimum Pulse Duration of the High Level, the maximum frequency is highly affected by the duty cycle Frequency Accuracy = \pm0.4%
EEPROM	128KB

Isolated Voltage	1000Vrms
Hardware	
ESD Protection	4 kV (Contact for each Channel)
LED	
CANopen Status	3 LEDs to PWR, RUN and ERR
Terminal Resister	1 LED to terminal resister indicator
Digital Input	8 LEDs as Digital Input Indicators
Power	
Power Supply	Unregulated +10 ~ +30 VDC
Power Consumption	1.5 W
Mechanism	
Dimensions	33 mm x 99 mm x 78 mm (W x L x H)
Environment	
Operating Temp.	-25 ~ 75 °C
Storage Temp.	-30 ~ 80 °C
Humidity	10 ~ 90% RH, non-condensing

1.4 Application

- Counting events or totalizing
- Detecting frequency
- Monitoring position or speed with quadrature encoder

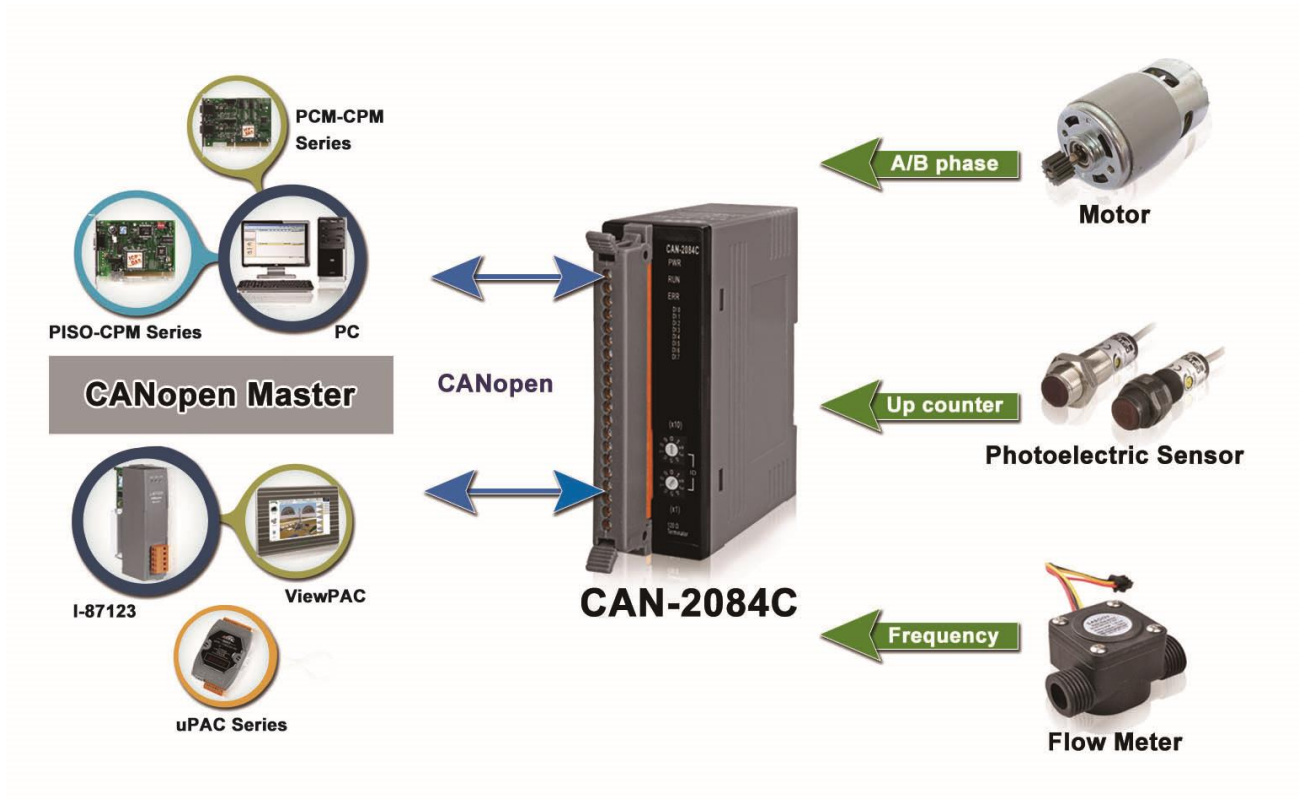

2. Hardware

2.1 Structure

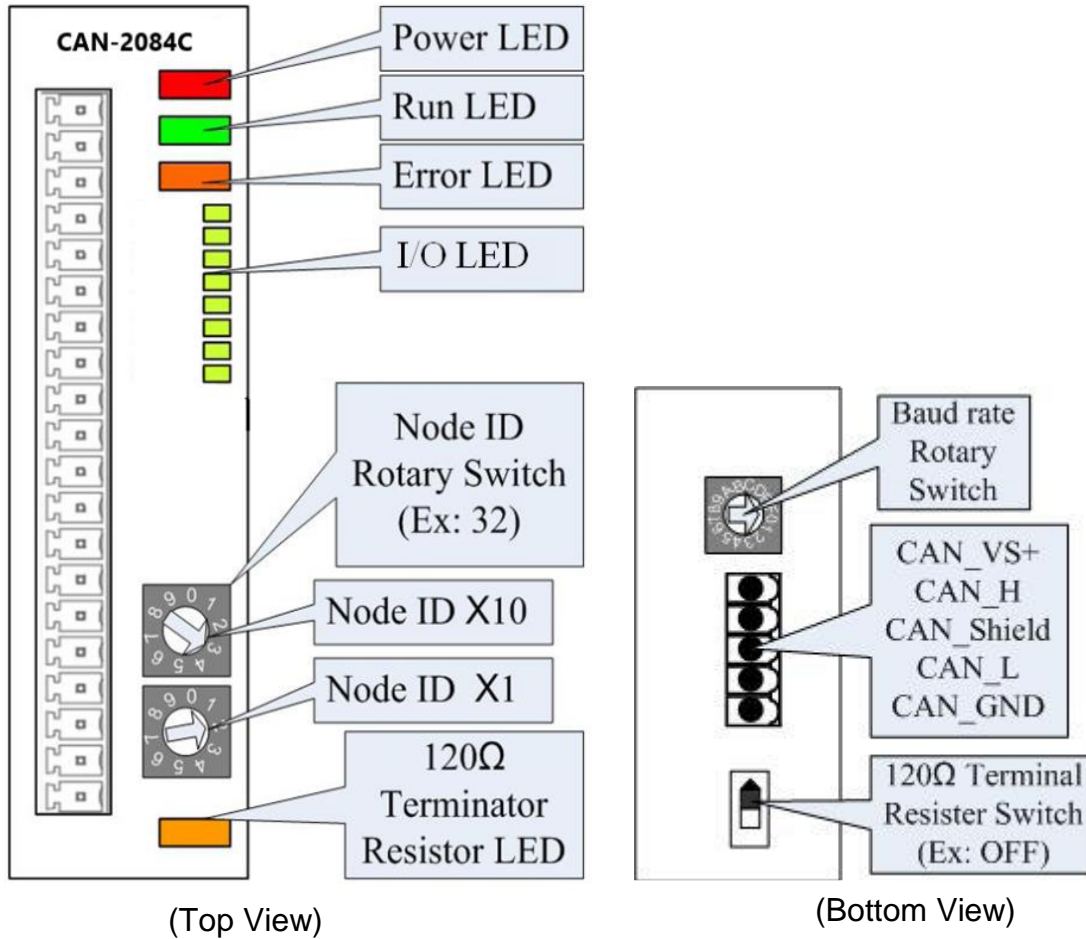

2.2 Node ID & Baud Rate Rotary Switch

The rotary switches for node ID configure the node ID of the CAN-2084C module. These two switches are for the tens digit and the units digit of node ID. The node ID value of this demo picture is 32.

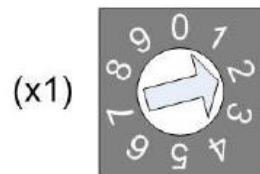
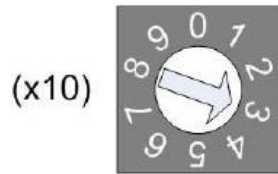

Node ID rotary switch

The rotary switch for baud rate handles the CAN baud rate of the CAN-2084C module. The relationship between the rotary switch value and the practical baud rate is presented in the following table.

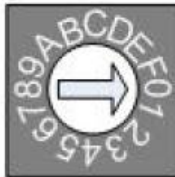

Baud rate rotary switch

Rotary Switch Value	Baud rate (k BPS)
0	10
1	20
2	50
3	125
4	250
5	500
6	800
7	1000

Baud rate and rotary switch

2.3 LED Description

Power LED

The CAN-2084C needs a 10V~30VDC power supply. Under a normal connection, a good power supply and a correct voltage selection, as the unit is turned on, the LED will light up in red.

Run LED

The Run LED indicates the CANopen operation state. The description of the LED state is shown below. About the details, please refer to the section 2.3.1 of the CAN-2000C user manual.

LED Signal	State	Description
No Light	Non-power	Power Supply is not ready
Single Flash	Stopped	The device is in Stopped state
Blinking	Pre-operation	The device is in the pre-operation state
Continuing Light	Operation	The device is in the operational state

Error LED





















The Error LED indicates the CANopen error state. The description of the LED state is shown below. About the details, please refer to the section 2.3.2 of the CAN-2000C user manual.

LED Signal	State	Description
No Light	Non error	Device is in working condition
Single Flash	Error Warning	At least one error of the CAN controller has occurred
Blinking	Guarding fail	Guard event happened
Continuing Light	Bus Off	The CAN controller is bus off



































Terminal Resistor LED

When the switch of the 120Ω terminal resistor is turned on, the terminal resistor LED will be lightening.

2.4 PIN Assignment

Terminal No [Ⓢ]	Pin Assignment [Ⓢ]
 01 [Ⓢ]	C0A+ [Ⓢ]
 02 [Ⓢ]	C0A- [Ⓢ]
 03 [Ⓢ]	C0B+ [Ⓢ]
 04 [Ⓢ]	C0B- [Ⓢ]
 05 [Ⓢ]	C1A+ [Ⓢ]
 06 [Ⓢ]	C1A- [Ⓢ]
 07 [Ⓢ]	C1B+ [Ⓢ]
 08 [Ⓢ]	C1B- [Ⓢ]
 09 [Ⓢ]	C2A+ [Ⓢ]
 10 [Ⓢ]	C2A- [Ⓢ]
 11 [Ⓢ]	C2B+ [Ⓢ]
 12 [Ⓢ]	C2B- [Ⓢ]
 13 [Ⓢ]	C3A+ [Ⓢ]
 14 [Ⓢ]	C3A- [Ⓢ]
 15 [Ⓢ]	C3B+ [Ⓢ]
 16 [Ⓢ]	C3B- [Ⓢ]
 17 [Ⓢ]	GND [Ⓢ]
 18 [Ⓢ]	GND [Ⓢ]
 19 [Ⓢ]	N.C [Ⓢ]
 20 [Ⓢ]	N.C [Ⓢ]

2.5 Wire Connection

Input Mode	Isolated	Non-isolated
Dir/Pulse	Vin+ (Pulse) —  CxA+ Vin- (Pulse) —  CxA- Vin+ (Dir) —  CxB+ Vin- (Dir) —  CxB-	Vin+ (Pulse) —  CxA+ Vin+ (Dir) —  CxB+ Vin- (Pulse) and Vin- (Dir) —  GND
Up/Down	Vin+ (Up) —  CxA+ Vin- (Up) —  CxA- Vin+ (Down) —  CxB+ Vin- (Down) —  CxB-	Vin+ (Up) —  CxA+ Vin+ (Down) —  CxB+ Vin- (Up) and Vin- (Down) —  GND
Up	Vin+ (Up0) —  CxA+ Vin- (Up0) —  CxA- Vin+ (Up1) —  CxB+ Vin- (Up1) —  CxB-	Vin+ (Up0) —  CxA+ Vin+ (Up1) —  CxB+ Vin- (Up0) and Vin-(Up1) —  GND
A/B Phase (Quadrant)	Vin+ (A0) —  CxA+ Vin- (A0) —  CxA- Vin+ (B0) —  CxB+ Vin- (B0) —  CxB-	Vin+ (A0) —  CxA+ Vin+ (B0) —  CxB+ Vin- (A0) and Vin-(B0) —  GND
Frequency	Vin+ (Freq0) —  CxA+ Vin- (Freq0) —  CxA- Vin+ (Freq1) —  CxB+ Vin- (Freq1) —  CxB-	Vin- (Freq0) —  CxA+ Vin- (Freq1) —  CxB+ Vin- (Freq0) and Vin-(Freq1) —  GND

The CAN-2084C has two kind of inputs, isolated and non-isolated (TTL) for different input signals. Users can switch jumper setting on the CAN-2084C board for appropriate signal. These jumpers are located within JP1~JP8. The jumper settings are listed in the following table. The isolated input is set by default.

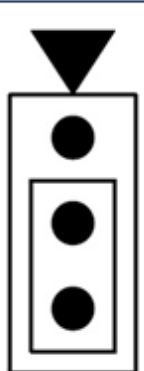
Jumper↕	Counter↕	Jumper setting↕	
JP1 ↕	A0↕	Isolated input (Default)↕	
JP2 ↕	B0↕		
JP3 ↕	A1↕		
JP4 ↕	B1↕		
JP5 ↕	A2↕		
JP6 ↕	B2↕		
JP7 ↕	A3↕		
JP8 ↕	B3↕		

2.6 Input Signal Model

Isolated Input (XOR=0)

The operational logic applied on CAN-2084C modules is a falling edge trigger. (Normal High and Active Low) The external signal is input into a CAN-2084C module through the isolation mechanism, with the signal being reversed from the external signal. This internal signal is the suggested waveform, as the XOR operation (XOR=0) doesn't need to be executed.

The solution is shown below.

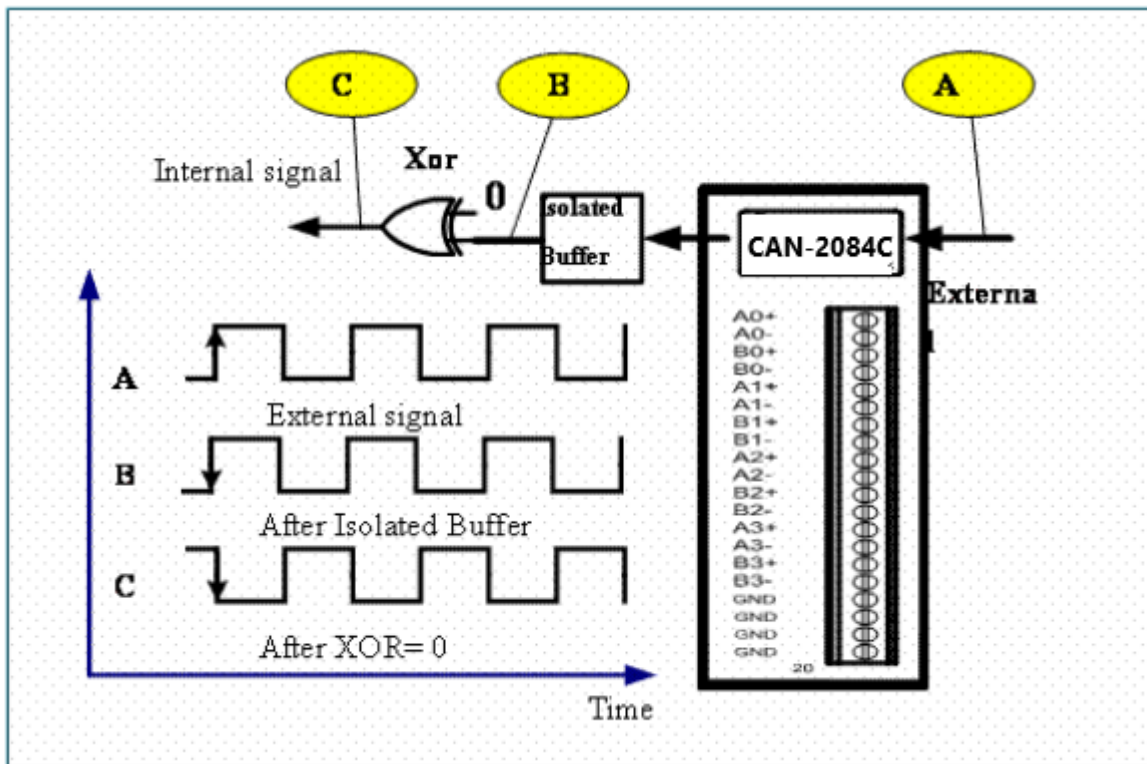

TTL Input (XOR=1)

When an external TTL signal is input into a CAN-2084C module through the TTL mechanism, the signal will be the same as the external signal. This internal signal isn't the recommended waveform as the exclusive OR (XOR=1) operation must be executed to invert the waveform.

The solution is shown below

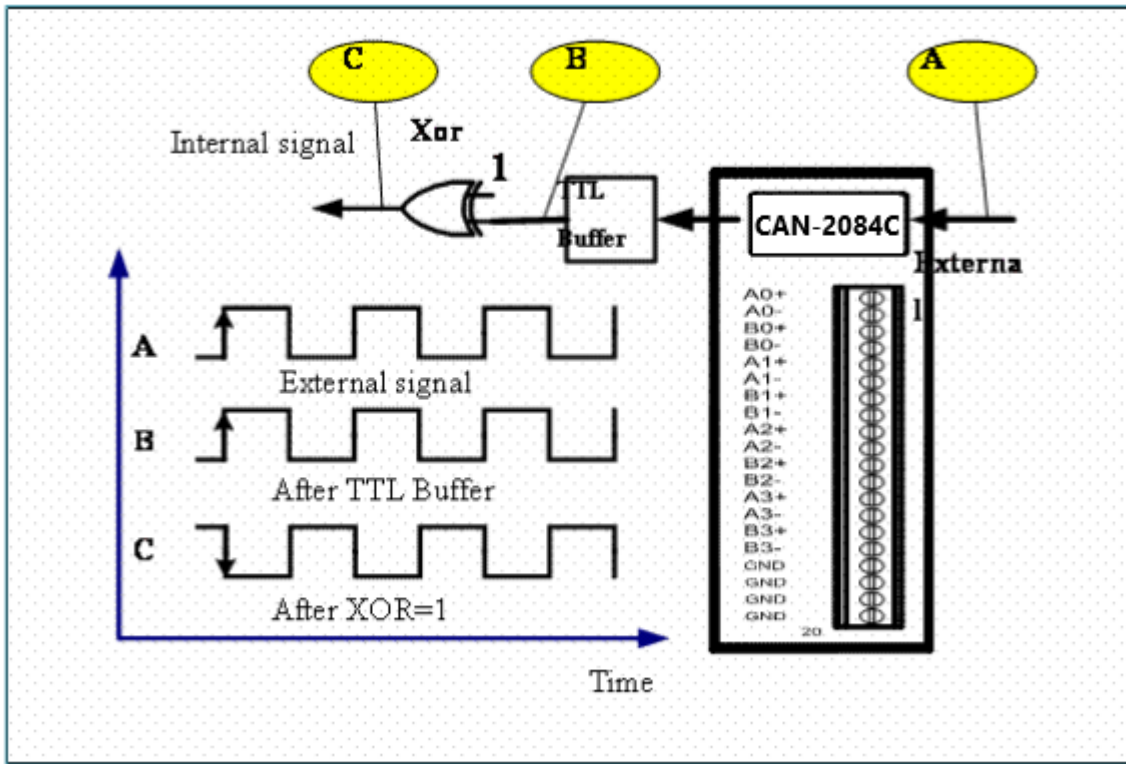

2.7 Digital Low Pass Filter

The CAN-2084C includes three independent 2nd-order digital noise filters that can be used to remove noise, and are implemented as follows:

Channel	Low Pass Filter
0 (A0)	Low Pass Filter 0
1 (B0)	
2 (A1)	Low Pass Filter 1
3 (B1)	
4 (A2)	Low Pass Filter 2
5 (B2)	
6 (A3)	
7 (B3)	

- The Low Pass Filter can be set to either enabled or disabled. The width of the Low Pass Filter is programmable and can be set within a range from 1 μ s to 32767 μ s.
- The Low Pass Filter can be applied to all working modes, both counter and frequency.
- All three Low Pass Filters are disabled by default when the module is shipped.

Refer to the following table for details of how to set the Low Pass Filter:

H = the HIGH width of the input signal T = the period of the filtering clock	
Case	Filtering status
H > 2T	The signal will be PASSED
T ≥ H ≥ 2T	The signal may be FILTERED or PASSED
H < T	The signal will be FILTERED

An example is illustrated in the following figure:

In this example, $H < T$ and the high width of the input signal < the period of the filtering clock, and so the signal will be filtered.

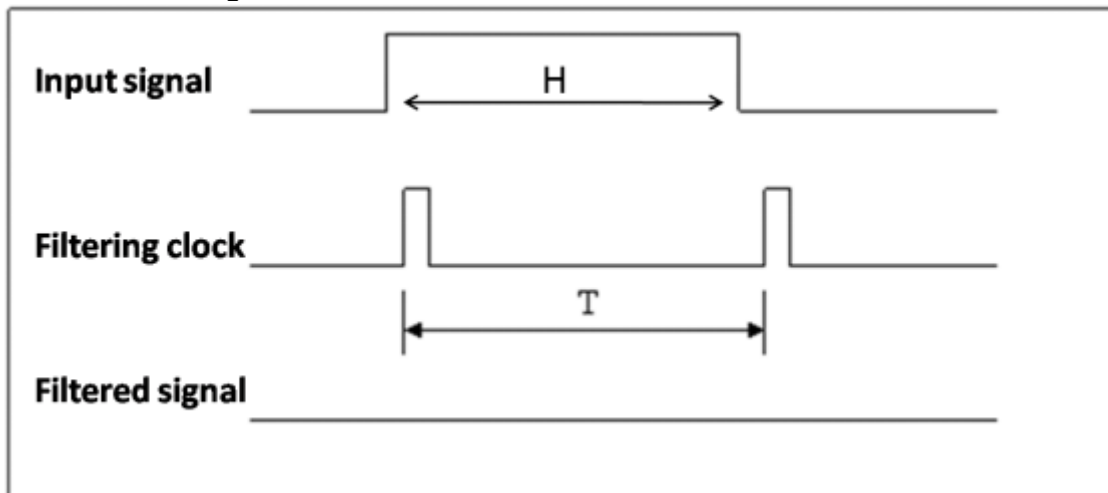

Supposed $T = 1$ ms, that is the filtering clock has a frequency of 1 kHz. Now, if the duty cycle of the input signal is 50%, that is the high width is equal to the low width, then:

- $H < T$ → $H < 1$ ms
- input signal period < 2 ms (duty cycle = 50%)
- input frequency > 500 Hz,

Consequently, the input signal will be filtered.

Now, if the duty cycle of the input signal is 25%, that is the low width is three times the high width, then:

- $H < T$ → $H < 1$ ms
- Input signal period < 4 ms (duty cycle = 25%)
- Input frequency > 250 Hz,

Consequently, the input signal will be filtered.

Similarly, the maximum period of the filtering clock can be calculated to allow the input signal to be passed using the formula $H > 2T$.

2.8 Counter Mode

2.8.1 Mode 0: Dir/Pulse Counting(Bi-direction)

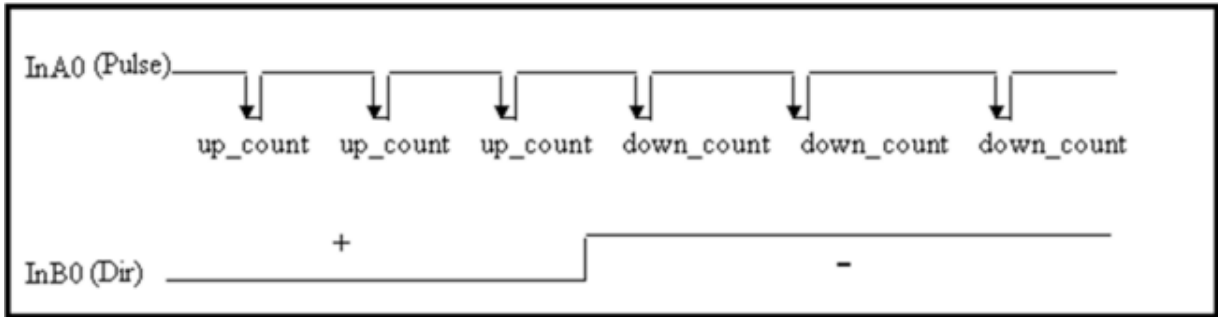

When InB0 is used as Dir:

- If InB0 is Low, counter will be increased by one for every falling edge of InA0.
- If InB0 is High, counter will be decreased by one for every falling edge of InA0.

2.8.2 Mode 1: Up/Down Counting

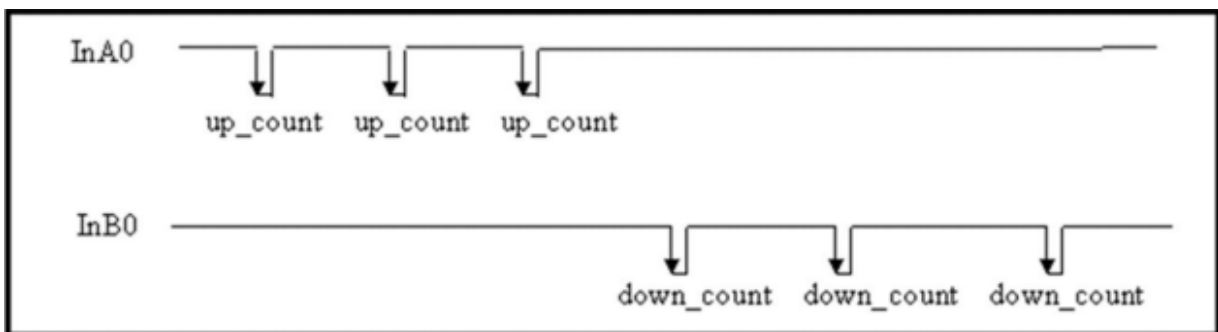

When InA0 is used as an UP_clock and InB0 is used as a DOWN_clock, counter_0 will be increased by one for every falling edge of InA0 and decreased by one for every falling edge of InB0.

2.8.3 Mode 2: Frequency Mode

We calculate frequency of a certain channel by how many counts in a period of time. There are two modes: Normal Mode and High Speed Mode for measurement frequency

Normal Mode:

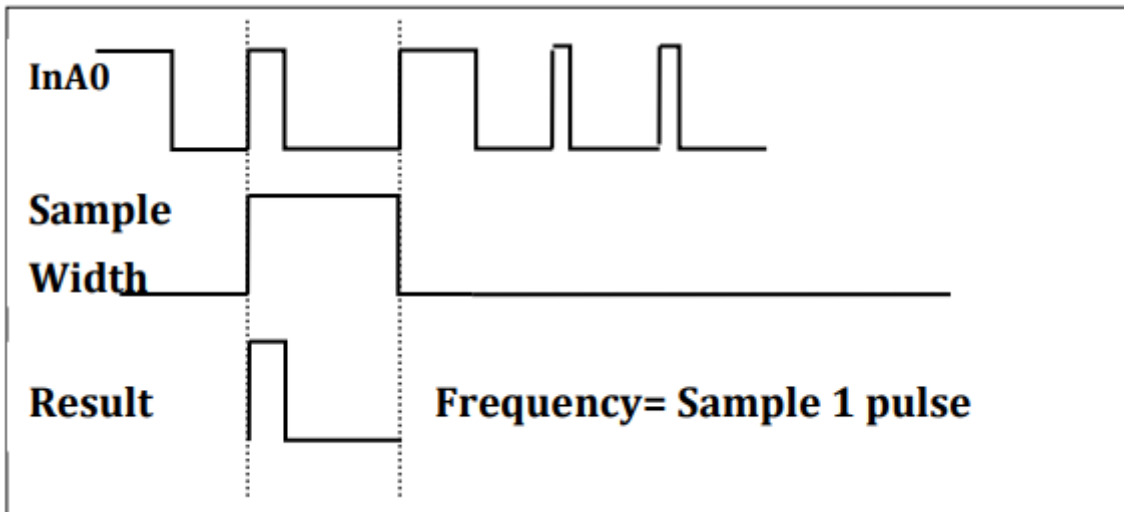

Normal Mode will read 1 pulse, this pulse will be calculated frequency value.

High Speed Mode:

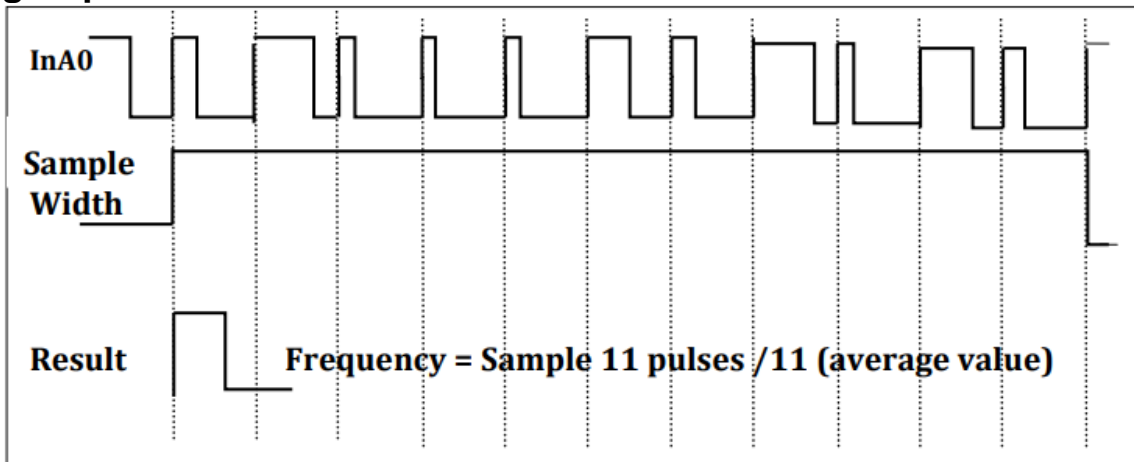

High Speed Mode will read 11 pulses to calculate average value of those 11 pulses.

High Speed Mode will be more accuracy than Normal mode for measurement Frequency. We suggest using High Speed Mode if measurement frequency is more than 10k Hz.

2.8.4 Mode 3: Up Counting

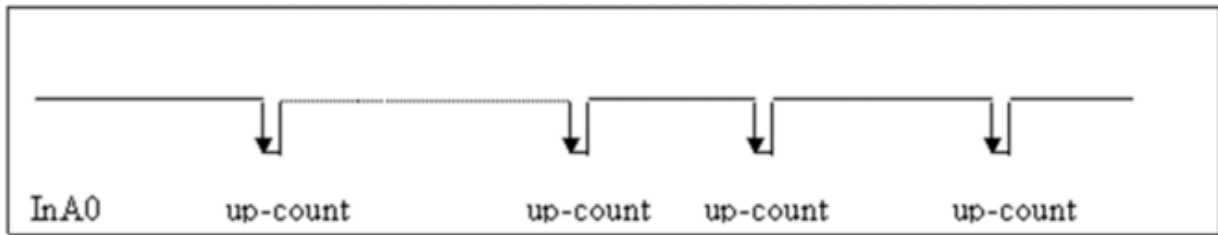

Counter_0 will be incremented by one for every falling edge of InA0

2.8.5 Mode 4: Quadrant Counting(A/B Phase)

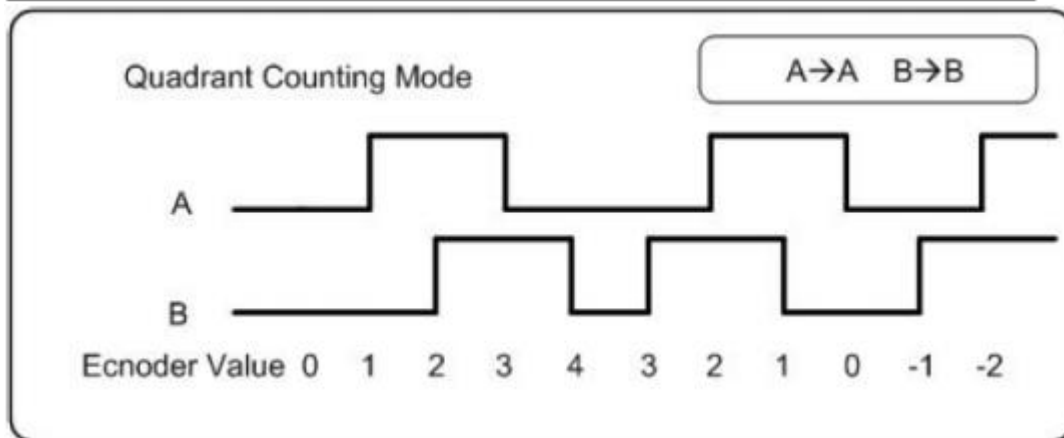
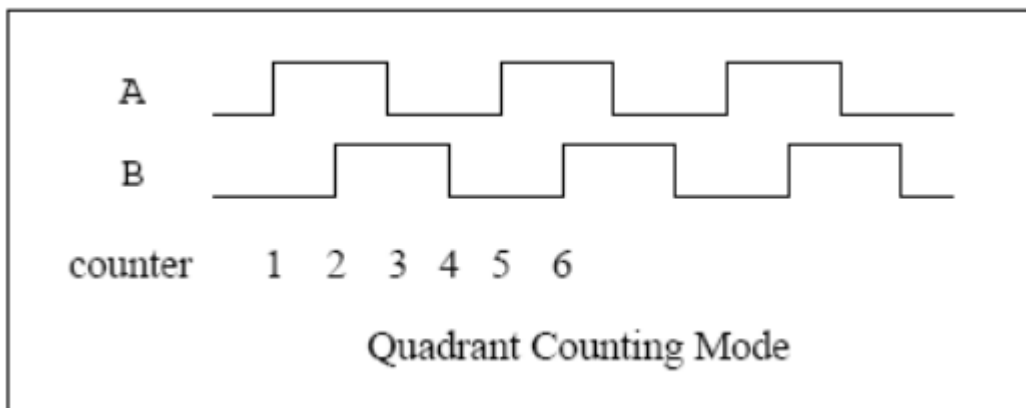

When InA0 is used as an A signal and InB0 is used as a B signal:

- Counter_0 will be increased by one when the InA0 phase leads by 90 degrees to InB0.
- Counter_0 will be decreased by one when the InA0 phase lags by 90 degrees to InB0.

3. Application

3.1 Object Dictionary

General Communication Entries

Idx	Sidx	Description	Type	Attr	Default
1000h	0h	device type	UNSIGNED 32	RO	---
1001h	0h	error register	UNSIGNED 8	RO	---
1003h	0h	largest sub-index supported for “predefine error field”	UNSIGNED 8	RO	0h
	1h	actual error (the newest one)	UNSIGNED 32	RO	---
	---
	5h	actual error (the oldest one)	UNSIGNED 32	RO	---
1005h	0h	COB-ID of Sync message	UNSIGNED 32	RW	80h
1008h	0h	manufacturer device name	VISIBLE_STRING	RO	
1009h	0h	manufacturer hardware version	VISIBLE_STRING	RO	---
100Ah	0h	manufacturer software version	VISIBLE_STRING	RO	---
100Ch	0h	guard time	UNSIGNED 16	RW	0
100Dh	0h	life time factor	UNSIGNED 8	RW	0
1010h	0h	largest subindex supported	UNSIGNED 8	RO	1
1010h	1h	save all parameters	UNSIGNED 32	RW	0
1011h	0h	largest subindex supported	UNSIGNED 8	RO	1
1011h	1h	restore all default parameters	UNSIGNED 32	RW	0
1014h	0h	COB-ID of EMCY	UNSIGNED 32	RW	80h+Node-ID
1015h	0h	Inhibit time of EMCY	UNSIGNED 16	RW	0
1017h	0h	Heartbeat time	UNSIGNED 16	RW	0
1018h	0h	largest sub-index supported for “identity object”	UNSIGNED 8	RO	4
	1h	vender ID	UNSIGNED 32	RO	0x0000013C
	2h	Produce Code	UNSIGNED 32	RO	0x00002026
	3h	Revision_number	UNSIGNED 32	RO	0x00030001
	4h	Serial_number	UNSIGNED 32	RO	0x6cd3683c

SDO Communication Entries

Idx	Sidx	Description	Type	Attr	Default
1200h	0h	largest sub-index supported for "server SDO parameter"	UNSIGNED 8	RO	2
	1h	COB-ID form client to server (RxSDO)	UNSIGNED 32	RO	600h+Node-ID
	2h	COB-ID form server to client (TxSDO)	UNSIGNED 32	RO	580h+Node-ID

RxPDO Communication Entries

Idx	Sidx	Description	Type	Attr	Default
1400h	0h	Number of entries	UNSIGNED 8	RO	2
	1h	COB-ID used by RxPDO	UNSIGNED 32	RW	200h+Node-ID
	2h	Transmission type	UNSIGNED 8	RW	FFh
1401h	0h	Number of entries	UNSIGNED 8	RO	2
	1h	COB-ID used by RxPDO	UNSIGNED 32	RW	300h+Node-ID
	2h	Transmission type	UNSIGNED 8	RW	FFh
1402h	0h	Number of entries"	UNSIGNED 8	RO	2
	1h	COB-ID used by RxPDO	UNSIGNED 32	RW	400h+Node-ID
	2h	Transmission type	UNSIGNED 8	RW	FFh
1403h	0h	Number of entries	UNSIGNED 8	RO	2
	1h	COB-ID used by RxPDO	UNSIGNED 32	RW	500h+Node-ID
	2h	Transmission type	UNSIGNED 8	RW	FFh
1404h	0h	Number of entries	UNSIGNED 8	RO	2
	1h	COB-ID used by RxPDO	UNSIGNED 32	RW	C0000000h
	2h	Transmission type	UNSIGNED 8	RW	---
...
1409h	0h	Number of entries	UNSIGNED 8	RO	2
	1h	COB-ID used by RxPDO	UNSIGNED 32	RW	C0000000h
	2h	Transmission type	UNSIGNED 8	RW	---

RxPDO Mapping Communication Entries

Idx	Sidx	Description	Type	Attr	Default
1600h	0h	Number of entries	UNSIGNED 8	RW	0
1601h	0h	Number of entries	UNSIGNED 8	RW	0
1602h	0h	Number of entries	UNSIGNED 8	RW	0
...
1609h	0h	Number of entries	UNSIGNED 8	RW	0

TxPDO Communication Entries

Idx	Sidx	Description	Type	Attr	Default
1800h	0h	Number of entries	UNSIGNED 8	RO	5
	1h	COB-ID used by TxPDO	UNSIGNED 32	RW	180h+Node-ID
	2h	Transmission type	UNSIGNED 8	RW	FFh
	3h	Inhibit time	UNSIGNED 16	RW	0
	4h	Reversed	---	---	---
	5h	Event timer	UNSIGNED 16	RW	0
1801h	0h	Number of entries	UNSIGNED 8	RO	5
	1h	COB-ID used by TxPDO	UNSIGNED 32	RW	280h+Node-ID
	2h	Transmission type	UNSIGNED 8	RW	FFh
	3h	Inhibit time	UNSIGNED 16	RW	0
	4h	Reversed	---	---	---
	5h	Event timer	UNSIGNED 16	RW	0
1802h	0h	Number of entries	UNSIGNED 8	RO	5
	1h	COB-ID used by TxPDO	UNSIGNED 32	RW	380h+Node-ID
	2h	Transmission type	UNSIGNED 8	RW	FFh
	3h	Inhibit time	UNSIGNED 16	RW	0
	4h	Reversed	---	---	---
	5h	Event timer	UNSIGNED 16	RW	0
1803h	0h	Number of entries	UNSIGNED 8	RO	5
	1h	COB-ID used by TxPDO	UNSIGNED 32	RW	480h+Node-ID
	2h	Transmission type	UNSIGNED 8	RW	FFh
	3h	Inhibit time	UNSIGNED 16	RW	0
	4h	Reversed	---	---	---
	5h	Event timer	UNSIGNED 16	RW	0
1804h	0h	Number of entries	UNSIGNED 8	RO	5
	1h	COB-ID used by TxPDO	UNSIGNED 32	RW	80000000h
	2h	Transmission type	UNSIGNED 8	RW	FFh
	3h	Inhibit time	UNSIGNED 16	RW	0
	4h	Reversed	---	---	---
	5h	Event timer	UNSIGNED 16	RW	0
...
1809h	0h	Number of entries	UNSIGNED 8	RO	5
	1h	COB-ID used by TxPDO	UNSIGNED 32	RW	80000000h
	2h	Transmission type	UNSIGNED 8	RW	FFh
	3h	Inhibit time	UNSIGNED 16	RW	0
	4h	Reversed
	5h	Event timer	UNSIGNED 16	RW	0

Note: The unit of “Inhibit time” is 100 us.

TxPDO Mapping Communication Entries

Idx	Sidx	Description	Type	Attr	Default
1A00h	0h	Number of entries	UNSIGNED 8	RO	0
1A01h	0h	Number of entries	UNSIGNED 8	RO	2
	1h	Read Counter value 1h	UNSIGNED 32	RW	3000 0120h
	2h	Read Counter value 2h	UNSIGNED 32	RW	3000 0220h
1A02h	0h	Number of entries	UNSIGNED 8	RO	2
	1h	Read Counter value 3h	UNSIGNED 32	RW	3000 0320h
	2h	Read Counter value 4h	UNSIGNED 32	RW	3000 0420h
1A03h	0h	Number of entries	UNSIGNED 8	RO	2
	1h	Read Counter value 5h	UNSIGNED 32	RW	3000 0520h
	2h	Read Counter value 6h	UNSIGNED 32	RW	3000 0620h
1A04h	0h	Number of entries	UNSIGNED 8	RO	2
	1h	Read Counter value 7h	UNSIGNED 32	RW	3000 0720h
	2h	Read Counter value 8h	UNSIGNED 32	RW	3000 0820h
1A05h	0h	Number of entries	UNSIGNED 8	RO	0
...
1A09h	0h	Number of entries	UNSIGNED 8	RO	0

Counter Type Entry

Idx	Sidx	Description	Type	Attr	Default
2004h	0h	Number of entries	UNSIGNED 8	RO	3h
	1h	Counter channel 0	UNSIGNED 8	RW	3h

	6h	Counter channel 5	UNSIGNED 8	RW	3h
	7h	Counter channel 6	UNSIGNED 8	RW	3h
	8h	Counter channel 7	UNSIGNED 8	RW	3h

Note: If user want to use Dir/Pulse, Up/Down or Quadrant Mode, user must set the paired channels in the same mode. For example, user use first set as Up/Down Counter, user need to set Channel 0 and Channel 1 into Up/Down Counting mode.

Counter Type

Type Code	Input Type	Number of counter sets
00	Dir/Pulse Counting Mode	4
01	Up/Down Counting Mode	4
02	Frequency Mode	8
03 (Default)	Up Counting Mode	8

04	Quadrant Counting Mode	4
----	------------------------	---

Counter Value Entry

Idx	Sidx	Description	Type	Attr	Default
3000h	0h	Number of entries	UNSIGNED 8	RO	8h
	1h	Channel 0 counter value	UNSIGNED 32	RO	0

	8h	Channel 7 counter value	UNSIGNED 32	RO	0

Overflow Value Entry

Idx	Sidx	Description	Type	Attr	Default
3001h	0h	Number of entries	UNSIGNED 8	RO	8h
	1h	Channel 0 overflow value	UNSIGNED 32	RO	0

	8h	Channel 7 overflow value	UNSIGNED 32	RO	0

Clear Counter Value Entry

Idx	Sidx	Description	Type	Attr	Default
3002h	0h	Number of entries	UNSIGNED 8	RO	8h
	1h	Clear Channel 0 counter value	UNSIGNED 8	WO	---
	---
	8h	Clear Channel 7 counter value	UNSIGNED 8	WO	---

Edge Type Entry

Idx	Sidx	Description	Type	Attr	Default
3003h	0h	Number of entries	UNSIGNED 8	RO	8h
	1h	Channel 0 Edge type	UNSIGNED 32	RW	0

	8h	Channel 7 Edge type	UNSIGNED 32	RW	0

Edge Type

Type Code	Edge Type
0 (default)	Falling
1	Rising

Frequency Mode Entry

Idx	Sidx	Description	Type	Attr	Default
3004h	0h	Number of entries	UNSIGNED 8	RO	8h
	1h	Channel 0 Frequency mode	UNSIGNED 32	RW	0

	8h	Channel 7 Frequency mode	UNSIGNED 32	RW	0
--	----	--------------------------	-------------	----	---

Note: When user set 2004 to 02(Frequency mode), user can use 3004 to determine which mode you want

Frequency Mode

Type Code	Frequency Mode
0 (default)	Normal mode
1	High speed mode

Frequency Time Out Value Entry

Idx	Sidx	Description	Type	Attr	Default
3005h	0h	Number of entries	UNSIGNED 8	RO	8h
	1h	Channel 0 frequency time out value	UNSIGNED 16	RW	0BB8h

	8h	Channel 7 frequency time out value	UNSIGNED 16	RW	0BB8h

Note:

Frequency time out value:

Default: 0xBB8 (3000ms)

Range: 0x0 ~ 0xFFFF

For example:

To measure 1k Hz frequency.

In normal mode, only needs 1 ms to update frequency value.

In High Speed mode, it will measure 11 times (necessary 1ms*11=11ms) and calculate frequency value.

Low Pass Filter Entry

Idx	Sidx	Description	Type	Attr	Default
3006h	0h	Number of entries	UNSIGNED 8	RO	8h
	1h	Channel 0 Low pass filter	UNSIGNED 8	RW	0

	8h	Channel 7 Low pass filter	UNSIGNED 8	RW	0

Note: 0 = Disable , 1 = Enable

Low Pass Filter Period Entry

Idx	Sidx	Description	Type	Attr	Default
3007h	0h	Number of entries	UNSIGNED 8	RO	8h
	1h	Channel 0 Low pass filter period	UNSIGNED 16	RW	1

	8h	Channel 7 Low pass filter period	UNSIGNED 16	RW	1

Note: Time Range: 1µs ~ 32767µs

Input Signal Model Entry

Idx	Sidx	Description	Type	Attr	Default
3008h	0h	Number of entries	UNSIGNED 8	RW	8h
	1h	Channel 0 input signal type	UNSIGNED 8	RW	1

	8h	Channel 7 input signal type	UNSIGNED 8	RW	1

Note: 0 = TTL , 1 = Isolated (default)

3.2 Store and Restore Object

The user can write the value 65766173h to object with index 1010h and subindex 1 to save the application setting, or write the value 64616F6Ch to the object with index 1011h and subindex 1 and reboot the module to load the factory default. The following table lists the relative objects which will be stored or restored after writing these two objects. The factory default for these objects is also shown below:

Index	Subindex	Description	Factory Default
2004h	1~8	Counter type code for channel 0 ~ 7	03h
3000h	1~8	Counter value	0
3001h	1~8	Overflow value	0
3002h	1~8	Clear counter value	--
3003h	1~8	Edge mode	0
3004h	1~8	Frequency mode	0
3005h	1~8	Frequency time out value	BB8h
3006h	1~8	Low pass filter	0
3007h	1~8	Low pass filter time	1
3008h	1~8	Input signal model	1

3.3 Application Object

Type code of CAN-2084C module (0x2004)

The user can read the object with index 2004h and subindex 1~8 to get the Counter type of the channel 0~7. If the user wants to change the Counter type, write the type code to the object with index 2004h and subindex 1~8. For example, if the node ID of CAN-2084C is 1, the following command would be used:

11-bit COB-ID (bit)											RTR	Data Length	8-byte Data (byte)							
Func Code				Node ID									0	1	2	3	4	5	6	7
10	9	8	7	6	5	4	3	2	1	0			0	1	2	3	4	5	6	7
1	1	0	0	0	0	0	0	0	0	1	0	8	2F	04	20	01	01	00	00	00

SDO client  SDO server (CAN-2084C)

11-bit COB-ID (bit)											RTR	Data Length	8-byte Data (byte)							
Func Code				Node ID									0	1	2	3	4	5	6	7
10	9	8	7	6	5	4	3	2	1	0			0	1	2	3	4	5	6	7
1	0	1	1	0	0	0	0	0	0	1	0	8	60	04	20	01	--	--	--	--

SDO client  SDO server (CAN-2084C)

Counter Value (0x3000)

Reading the object with index 3000h and subindex 1~8 to get the Counter value of the channel 0~7.

11-bit COB-ID (bit)											RTR	Data Length	8-byte Data (byte)							
Func Code				Node ID									0	1	2	3	4	5	6	7
10	9	8	7	6	5	4	3	2	1	0			0	1	2	3	4	5	6	7
1	1	0	0	0	0	0	0	0	0	1	0	8	40	00	30	01	00	00	00	00

SDO client  SDO server (CAN-2084C)

11-bit COB-ID (bit)											RTR	Data Length	8-byte Data (byte)							
Func Code				Node ID									0	1	2	3	4	5	6	7
10	9	8	7	6	5	4	3	2	1	0										
1	0	1	1	0	0	0	0	0	0	1	0	8	43	00	30	01	00	00	00	

SDO client



SDO server
(CAN-2084C)

Overflow value (0x3001)

Reading the object with index 3001h and subindex 1~8 to get the Overflow value of the channel 0~7.

11-bit COB-ID (bit)											RTR	Data Length	8-byte Data (byte)							
Func Code				Node ID									0	1	2	3	4	5	6	7
10	9	8	7	6	5	4	3	2	1	0										
1	1	0	0	0	0	0	0	0	0	1	0	8	40	01	30	01	00	00	00	

SDO client



SDO server
(CAN-2084C)

11-bit COB-ID (bit)											RTR	Data Length	8-byte Data (byte)							
Func Code				Node ID									0	1	2	3	4	5	6	7
10	9	8	7	6	5	4	3	2	1	0										
1	0	1	1	0	0	0	0	0	0	1	0	8	43	01	30	01	00	00	00	

SDO client



SDO server
(CAN-2084C)

Clear Counter Value (0x3002)

This object is used to clear the channels counter value and it's write only.

For example, if the node ID of the CAN-2084C is 1, the commands are as follows:

11-bit COB-ID (bit)											RTR	Data	8-byte Data (byte)							
---------------------	--	--	--	--	--	--	--	--	--	--	-----	------	--------------------	--	--	--	--	--	--	--

Func Code				Node ID								Length								
10	9	8	7	6	5	4	3	2	1	0			0	1	2	3	4	5	6	7
1	1	0	0	0	0	0	0	0	0	1	0	8	2F	02	30	01	00	00	00	



11-bit COB-ID (bit)											RTR	Data Length	8-byte Data (byte)							
Func Code				Node ID									0	1	2	3	4	5	6	7
10	9	8	7	6	5	4	3	2	1	0			0	1	2	3	4	5	6	7
1	0	1	1	0	0	0	0	0	0	1	0	8	60	02	30	01	---	---	---	---

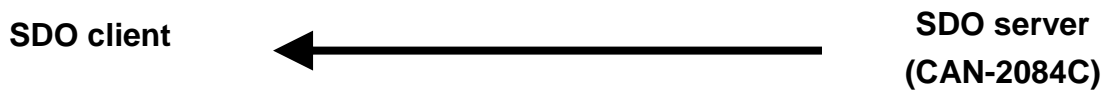

If Data0 is 60, that means the CAN-2084C writes data successfully.
 If Data0 is 80, that means it fails.

Select Edge Mode (0x3003)

This object can be used to select the detecting method of counter. There are three modes can be selected, falling, rising, or both.

For example, if the node ID of CAN-2084C is 1, the commands are shown below:

11-bit COB-ID (bit)											RTR	Data Length	8-byte Data (byte)							
Func Code				Node ID									0	1	2	3	4	5	6	7
10	9	8	7	6	5	4	3	2	1	0			0	1	2	3	4	5	6	7
1	1	0	0	0	0	0	0	0	0	1	0	8	2F	03	30	01	01	00	00	00

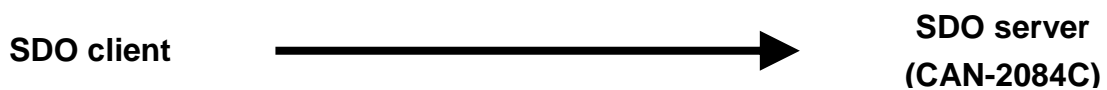

11-bit COB-ID (bit)											RTR	Data Length	8-byte Data (byte)							
Func Code				Node ID									0	1	2	3	4	5	6	7
10	9	8	7	6	5	4	3	2	1	0			0	1	2	3	4	5	6	7
1	0	1	1	0	0	0	0	0	0	1	0	8	60	03	30	01	---	---	---	---

SDO client



SDO server
(CAN-2084C)

If Data0 is 60, that means the CAN-2084C writes data successfully.
If Data0 is 80, that means it fails.

Select Frequency Mode (0x3004)

This object can be used to select the frequency mode. There are two modes can be selected, normal mode and High speed mode. **Note:** If user doesn't choose frequency mode in object 0x2004, 0x3004 make no difference to CAN-2084C module.

For example, if the node ID of CAN-2084C is 1, the commands are shown below:

11-bit COB-ID (bit)											RTR	Data Length	8-byte Data (byte)							
Func Code				Node ID									0	1	2	3	4	5	6	7
10	9	8	7	6	5	4	3	2	1	0										
1	1	0	0	0	0	0	0	0	0	1	0	8	2F	04	30	01	01	00	00	00

SDO client



SDO server
(CAN-2084C)

11-bit COB-ID (bit)											RTR	Data Length	8-byte Data (byte)							
Func Code				Node ID									0	1	2	3	4	5	6	7
10	9	8	7	6	5	4	3	2	1	0										
1	0	1	1	0	0	0	0	0	0	1	0	8	60	04	30	01	---	---	---	---

SDO client



SDO server
(CAN-2084C)

If Data0 is 60, that means the CAN-2084C writes data successfully.
If Data0 is 80, that means it fails.

Set Frequency Time Out Value (0x3005)

User can use this object to set the frequency time out value. The default value is 0xBB8(3000ms) and the range is from 0x0 to 0xFFFF(65535ms). **Note:** If user doesn't choose frequency mode in object 0x2004, 0x3005 make no difference to CAN-2084C module.

For example, if the node ID of CAN-2084C is 1, the commands are shown below:

11-bit COB-ID (bit)											RTR	Data Length	8-byte Data (byte)							
Func Code				Node ID									0	1	2	3	4	5	6	7
10	9	8	7	6	5	4	3	2	1	0			0	1	2	3	4	5	6	7
1	1	0	0	0	0	0	0	0	0	1	0	8	2B	05	30	01	FF	FF	00	00



11-bit COB-ID (bit)											RTR	Data Length	8-byte Data (byte)							
Func Code				Node ID									0	1	2	3	4	5	6	7
10	9	8	7	6	5	4	3	2	1	0			0	1	2	3	4	5	6	7
1	0	1	1	0	0	0	0	0	0	1	0	8	60	05	30	01	---	---	---	---

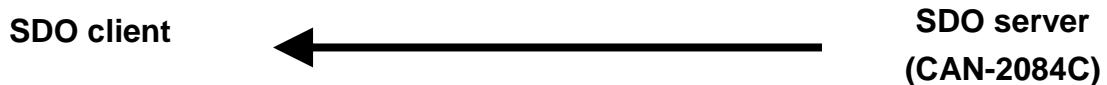

If Data0 is 60, that means the CAN-2084C writes data successfully.
 If Data0 is 80, that means it fails.

Turn On/Off Low Pass Filter (0x3006)

User can use this object to turn on/off the low pass filter of channel0~7.

For example, if the node ID of CAN-2084C is 1, the commands are shown below:

11-bit COB-ID (bit)											RTR	Data Length	8-byte Data (byte)							
Func Code				Node ID									0	1	2	3	4	5	6	7
10	9	8	7	6	5	4	3	2	1	0			0	1	2	3	4	5	6	7
1	1	0	0	0	0	0	0	0	0	1	0	8	2F	06	30	01	01	00	00	00



11-bit COB-ID (bit)											RTR	Data Length	8-byte Data (byte)							
Func Code				Node ID									0	1	2	3	4	5	6	7
10	9	8	7	6	5	4	3	2	1	0			0	1	2	3	4	5	6	7
1	0	1	1	0	0	0	0	0	0	1	0	8	60	06	30	01	---	---	---	---

SDO client



SDO server
(CAN-2084C)

If Data0 is 60, that means the CAN-2084C writes data successfully.
If Data0 is 80, that means it fails.

Set Low Pass Filter Time (0x3007)

User can use this object to set the low pass filter time of channel0~7. The default value is 1μs, and the range is 1μs ~32767μs(0x01~0x7FFF).

For example, if the node ID of CAN-2084C is 1, the commands are shown below:

11-bit COB-ID (bit)											RTR	Data Length	8-byte Data (byte)							
Func Code				Node ID									0	1	2	3	4	5	6	7
10	9	8	7	6	5	4	3	2	1	0										
1	1	0	0	0	0	0	0	0	0	1	0	8	2B	07	30	01	FF	7F	00	00

SDO client



SDO server
(CAN-2084C)

11-bit COB-ID (bit)											RTR	Data Length	8-byte Data (byte)							
Func Code				Node ID									0	1	2	3	4	5	6	7
10	9	8	7	6	5	4	3	2	1	0										
1	0	1	1	0	0	0	0	0	0	1	0	8	60	07	30	01	---	---	---	---

SDO client



SDO server
(CAN-2084C)

If Data0 is 60, that means the CAN-2084C writes data successfully.
If Data0 is 80, that means it fails.

Set Input Signal Model (0x3008)

User can use this object to get channel0~7 into isolated or non-isolated(TTL) model.

For example, if the node ID of CAN-2084C is 1, the commands are shown below:

11-bit COB-ID (bit)											RTR	Data Length	8-byte Data (byte)							
Func Code				Node ID									0	1	2	3	4	5	6	7
10	9	8	7	6	5	4	3	2	1	0										

1	1	0	0	0	0	0	0	0	0	0	1	0	8	2F	08	30	01	01	00	00	00
---	---	---	---	---	---	---	---	---	---	---	---	---	---	----	----	----	----	----	----	----	----

SDO client



SDO server
(CAN-2084C)

11-bit COB-ID (bit)											RTR	Data Length	8-byte Data (byte)							
Func Code				Node ID									0	1	2	3	4	5	6	7
10	9	8	7	6	5	4	3	2	1	0										
1	0	1	1	0	0	0	0	0	0	1	0	8	60	08	30	01	---	---	---	---

SDO client



SDO server
(CAN-2084C)

If Data0 is 60, that means the CAN-2084C writes data successfully.
If Data0 is 80, that means it fails.

Set Module to Operation Mode when powering on (0x2100)

This object 0x2100 with subindex 1 defines if the module will enter operation mode automatically when powering on.

For example, if the node id of CAN-2084C is 1, the commands are as below:

11-bit COB-ID (bit)											RTR	Data Length	8-byte Data (byte)							
Func Code				Node ID									0	1	2	3	4	5	6	7
10	9	8	7	6	5	4	3	2	1	0										
1	1	0	0	0	0	0	0	0	0	1	0	8	2F	00	21	01	01	00	00	00

ID(hex)	RTR	DLC	D1	D2	D3	D4	D5	D6	D7	D8
601	0	8	2F	00	21	01	01	00	00	00

SDO client



SDO server
(CAN-2084C)

11-bit COB-ID (bit)											RTR	Data Length	8-byte Data (byte)							
Func Code				Node ID									0	1	2	3	4	5	6	7
10	9	8	7	6	5	4	3	2	1	0										
1	0	1	1	0	0	0	0	0	0	1	0	8	60	00	21	01	--	--	--	--

ID(hex)	RTR	DLC	D1	D2	D3	D4	D5	D6	D7	D8
581	0	8	60	00	21	01	00	00	00	00

SDO client



SDO server
(CAN-2084C)

Write object index 0x2100 with subindex 1 to 0x01 then store the setting as below.
Module will enter operation mode when powering on.

11-bit COB-ID (bit)											RTR	Data Length	8-byte Data (byte)							
Func Code				Node ID									0	1	2	3	4	5	6	7
10	9	8	7	6	5	4	3	2	1	0										
1	1	0	0	0	0	0	0	0	0	1	0	8	23	10	10	01	73	61	76	65

ID(hex)	RTR	DLC	D1	D2	D3	D4	D5	D6	D7	D8
601	0	8	23	10	10	01	73	61	76	65

SDO client



SDO server
(CAN-2084C)

11-bit COB-ID (bit)											RTR	Data Length	8-byte Data (byte)							
Func Code				Node ID									0	1	2	3	4	5	6	7
10	9	8	7	6	5	4	3	2	1	0										
1	0	1	1	0	0	0	0	0	0	1	0	8	60	10	10	01	--	--	--	--

ID(hex)	RTR	DLC	D1	D2	D3	D4	D5	D6	D7	D8
581	0	8	60	10	10	01	00	00	00	00

SDO client



SDO server
(CAN-2084C)

3.4 Default PDO Mapping

TxPDO mapping list:

ID	Led	D0	D1	D2	D3	D4	D5	D6	D7
180h+x	0	Reserved							
280h+x	0	Counter Value ch0				Counter Value ch1			
380h+x	0	Counter Value ch2				Counter Value ch3			
480h+x	0	Counter Value ch4				Counter Value ch5			

3.5 EMCY Communication

The data format of the emergency object data follows the structure below.

Byte	0	1	2	3	4	5	6	7
Content	Emergency Error code		Error register	Manufacturer specific Error Field				

Each bit on the error register is defined as follows.

Bit	Meaning
0	Generic error
1	Current
2	Voltage
3	Temperature
4	Communication error (Overrun, error state)
5	Device profile specific
6	Reserved (Always 0)
7	Manufacturer specific

The Emergency error codes and the error register are specified in the following table.

Emergency Error Code		Error Register	Manufacture Specific Error Field		Description	
High Byte	Low Byte		First Byte	Last Four Bytes		
00	00	00	00	00 00 00 00	Error Reset or No Error	
10	00	81	01	00 00 00 00	CAN controller Error Occur	
50	00	81	02	00 00 00 00	EEPROM Access Error	
81	01	11	04	00 00 00 00	Soft Rx Buffer Overrun	
81	01	11	05	00 00 00 00	Soft Tx Buffer Overrun	
81	01	11	06	00 00 00 00	CAN controller Overrun	
81	30	11	07	00 00 00 00	Lift Guarding Fail	
81	40	11	08	00 00 00 00	Recover From Bus Off	
82	10	11	09	00 00 00 00	PDO Data Length Error	
FF	00	80	0A	00 00 00 00	Request To Reset Node or Communication	
FF	00	2E	0B	00 00 Upper limit alarm	00 00 Lower limit alarm	Upper/Lower limit alarm for Each channel

