

Datasheet

SATADOM-MV 3ME3 series

- Best boot drive solution for server and embedded system
- SATA 6Gb/s interface
- High IOPS to reduce boot up timing
- Built-in Pin 7 power supply
- DRAM-less, 100% data integrity
- Innovative Firmware Algorithm
- Anti-vibration mechanical design
- Built in iData Guard



Introduction

Innodisk SATADOM-MV 3ME3 is designed as the standard SATA 7 pin connector with SATA interface, and supports SATA III standard (6.0Gb/s) with excellent performance. Innodisk SATADOM-MV 3ME3 absolutely replaces the traditional hard disk and makes personal computer, in any field, smaller and easier.

Innodisk SATADOM-MV 3ME3 effectively reduces the booting time of operation system and the power consumption is less than hard disk drive (HDD), and complies with ATA protocol, no additional drives are required, and can be configured as a boot device or data storage device.

SATADOM-MV

3ME3 series

Contact us for more information about the SATADOM-MV 3ME3.

Innodisk is a service-driven provider of industrial embedded flash storage products and technologies, with a focus on the cloud computing, industrial/embedded, and aerospace and defense industries.

Diagram

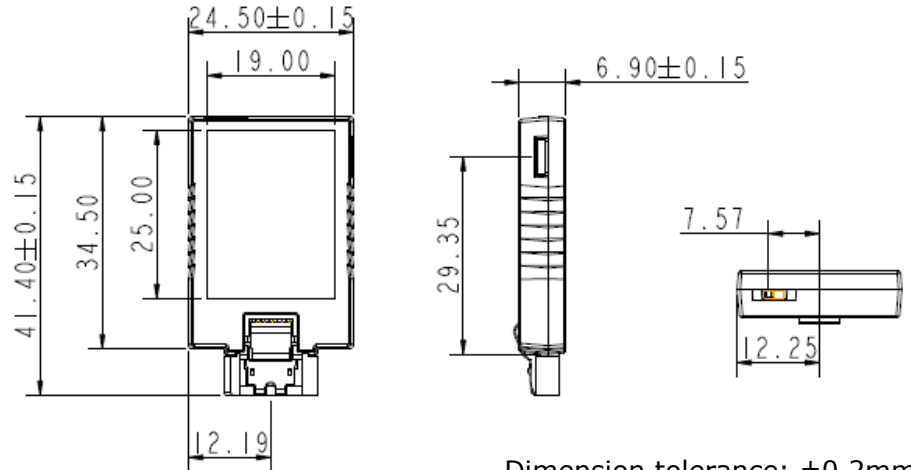

Dimension tolerance: ±0.2mm

Specifications

Interface	SATA III
Flash Type	MLC
Capacity	8GB~128GB
Max. Channels	4
Sequential R/W (MB/sec, max.)	220 / 80
Max. Power Consumption	1.8W (5V x 370mA)
Thermal Sensor	ST- Optional/ WT- Default
External DRAM buffer	-
H/W Write Protect	√
ATA Security	√
S.M.A.R.T.	√
Dimension (WxLxH)	25.2 X 41.5 X 6.8 mm
Environment	Vibration: 20G @7~2000Hz Shock: 1500G @ 0.5ms Storage Temperature: -55°C ~ +95°C MTBF: 3 million hours

Headquarters (Taiwan)

5F., No. 237, Sec. 1, Datong Rd.,
Xizhi Dist., New Taipei City,
Taiwan (R.O.C.)
Tel: +886-2-7703-3000
Email: sales@innodisk.com

Branch Offices:

USA
usasales@innodisk.com
+1-510-770-9421
Europe
eusales@innodisk.com
+31-(0)40-282-1818
Japan
jpsales@innodisk.com
+81-3-6667-0161
China
sales_cn@innodisk.com
+86-755-21673689
www.innodisk.com

© 2015 Innodisk Corporation.
All right reserved. Specifications
are subject to change without
prior notice.

201600831

Ordering Information

Operation Temp.	8GB	16GB	32GB	64GB	128GB
Standard Grade (0°C ~ +70°C)	DESMV-08GD09*C1SC(F)	DESMV-16GD09*C1DC(F)	DESMV-32GD09*C1DC(F)	DESMV-64GD09*C1DC(F)	DESMV-A28D09*C1DC(F)
Industrial Grade (-40°C ~ +85°C)	DESMV-08GD09*W1SC(F)	DESMV-16GD09*W1DC(F)	DESMV-32GD09*W1DC(F)	DESMV-64GD09*W1DC(F)	DESMV-A28D09*W1DC(F)

*S: Toshiba A19 nm MLC/ B: Toshiba 15nm MLC

PN end with F is SATADOM Pin 7 with power supply version, which doesn't provide power cable.

innodisk

www.innodisk.com