



**NEXCOM International Co., Ltd.**

**Network and Communication Solutions**

**Desktop Fixed Wireless Access Appliance**

**DFA1163**

User Manual

# CONTENTS

## Preface

Copyright .....	iv
Disclaimer .....	iv
Acknowledgements .....	iv
Regulatory Compliance Statements .....	iv
Declaration of Conformity .....	iv
RoHS Compliance .....	v
Warranty and RMA .....	vi
Safety Information .....	viii
Installation Recommendations .....	viii
Safety Precautions .....	ix
Technical Support and Assistance .....	x
Conventions Used in this Manual .....	x
Global Service Contact Information .....	xi
Package Contents .....	xiii
Package Contents Cont. ....	xiv
Package Contents .....	xv
Ordering Information .....	xvi

## Chapter 1: Product Introduction

Overview .....	1
Key Features .....	1
Hardware Specifications .....	2
Knowing Your DFA1163 .....	3
Front Panel .....	3

Rear Panel .....	4
Mechanical Dimensions .....	5

## Chapter 2: Jumpers and Connectors

Before You Begin .....	6
Precautions .....	6
Jumper Settings .....	7
Locations of the Jumpers and Connectors .....	8
Jumpers .....	9
RTC Clear .....	9
PMC Clear .....	9
Connector Pin Definitions .....	10
External I/O Interfaces .....	10
DC-12V Power Connector .....	10
+54V DC IN .....	10
System Power Button .....	11
USB 3.0 .....	11
LAN Connector .....	12
LAN Connector .....	12
LAN Connector .....	13
LAN Connector .....	14
Console Port & USB 3.0 .....	14
MGMT Port & USB 3.0 .....	15
Internal Connectors .....	16
Fan Connector .....	16
GPIO .....	16

TPM .....	17
Block Diagram .....	18

## Chapter 3: System Setup

Removing the Chassis Cover .....	19
Installing a DIMM Memory Module .....	21
Installing the M.2 Module .....	22
Installing Both the 5G and Wi-Fi Module .....	23

## Chapter 4: BIOS Setup

About BIOS Setup .....	26
When to Configure the BIOS .....	26
Default Configuration .....	27
Entering Setup .....	27
Legends .....	27
BIOS Setup Utility .....	29
Main .....	29
Advanced .....	30
Intel RC Setup .....	40
Security .....	49
Boot .....	49
Save & Exit .....	50

# PREFACE

## Copyright

This publication, including all photographs, illustrations and software, is protected under international copyright laws, with all rights reserved. No part of this manual may be reproduced, copied, translated or transmitted in any form or by any means without the prior written consent from NEXCOM International Co., Ltd.

## Disclaimer

The information in this document is subject to change without prior notice and does not represent commitment from NEXCOM International Co., Ltd. However, users may update their knowledge of any product in use by constantly checking its manual posted on our website: <http://www.nexcom.com>. NEXCOM shall not be liable for direct, indirect, special, incidental, or consequential damages arising out of the use of any product, nor for any infringements upon the rights of third parties, which may result from such use. Any implied warranties of merchantability or fitness for any particular purpose is also disclaimed.

## Acknowledgements

DFA1163 is a trademark of NEXCOM International Co., Ltd. All other product names mentioned herein are registered trademarks of their respective owners.

## Regulatory Compliance Statements

This section provides the FCC compliance statement for Class B devices and describes how to keep the system CE compliant.

## Declaration of Conformity

### FCC

This equipment has been tested and verified to comply with the limits for a Class B digital device, pursuant to Part 15 of FCC Rules. These limits are designed to provide reasonable protection against harmful interference when the equipment is operated in a commercial environment. This equipment generates, uses, and can radiate radio frequency energy and, if not installed and used in accordance with the instructions, may cause harmful interference to radio communications. Operation of this equipment in a residential area (domestic environment) is likely to cause harmful interference, in which case the user will be required to correct the interference (take adequate measures) at their own expense.

### CE

The product(s) described in this manual complies with all applicable European Union (CE) directives if it has a CE marking. For computer systems to remain CE compliant, only CE-compliant parts may be used. Maintaining CE compliance also requires proper cable and cabling techniques.

## RoHS Compliance



### **NEXCOM RoHS Environmental Policy and Status Update**

NEXCOM is a global citizen for building the digital infrastructure. We are committed to providing green products and services, which are compliant with European Union RoHS (Restriction on Use of Hazardous Substance in Electronic Equipment) directive 2011/65/EU, to be your trusted green partner and to protect our environment.

RoHS restricts the use of Lead (Pb) < 0.1% or 1,000ppm, Mercury (Hg) < 0.1% or 1,000ppm, Cadmium (Cd) < 0.01% or 100ppm, Hexavalent Chromium (Cr6+) < 0.1% or 1,000ppm, Polybrominated biphenyls (PBB) < 0.1% or 1,000ppm, and Polybrominated diphenyl Ethers (PBDE) < 0.1% or 1,000ppm.

In order to meet the RoHS compliant directives, NEXCOM has established an engineering and manufacturing task force in to implement the introduction of green products. The task force will ensure that we follow the standard NEXCOM development procedure and that all the new RoHS components and new manufacturing processes maintain the highest industry quality levels for which NEXCOM are renowned.

The model selection criteria will be based on market demand. Vendors and suppliers will ensure that all designed components will be RoHS compliant.

### **How to recognize NEXCOM RoHS Products?**

For existing products where there are non-RoHS and RoHS versions, the suffix "(LF)" will be added to the compliant product name.

All new product models launched after January 2013 will be RoHS compliant. They will use the usual NEXCOM naming convention.

## Warranty and RMA

### NEXCOM Warranty Period

NEXCOM manufactures products that are new or equivalent to new in accordance with industry standard. NEXCOM warrants that products will be free from defect in material and workmanship for 2 years, beginning on the date of invoice by NEXCOM. HCP series products (Blade Server) which are manufactured by NEXCOM are covered by a three year warranty period.

### NEXCOM Return Merchandise Authorization (RMA)

- Customers shall enclose the “NEXCOM RMA Service Form” with the returned packages.
- Customers must collect all the information about the problems encountered and note anything abnormal or, print out any on-screen messages, and describe the problems on the “NEXCOM RMA Service Form” for the RMA number apply process.
- Customers can send back the faulty products with or without accessories (manuals, cable, etc.) and any components from the card, such as CPU and RAM. If the components were suspected as part of the problems, please note clearly which components are included. Otherwise, NEXCOM is not responsible for the devices/parts.
- Customers are responsible for the safe packaging of defective products, making sure it is durable enough to be resistant against further damage and deterioration during transportation. In case of damages occurred during transportation, the repair is treated as “Out of Warranty.”
- Any products returned by NEXCOM to other locations besides the customers’ site will bear an extra charge and will be billed to the customer.

### Repair Service Charges for Out-of-Warranty Products

NEXCOM will charge for out-of-warranty products in two categories, one is basic diagnostic fee and another is component (product) fee.

### Repair Service Charges for Out-of-Warranty Products

NEXCOM will charge for out-of-warranty products in two categories, one is basic diagnostic fee and another is component (product) fee.

### System Level

- Component fee: NEXCOM will only charge for main components such as SMD chip, BGA chip, etc. Passive components will be repaired for free, ex: resistor, capacitor.
- Items will be replaced with NEXCOM products if the original one cannot be repaired. Ex: motherboard, power supply, etc.
- Replace with 3rd party products if needed.
- If RMA goods can not be repaired, NEXCOM will return it to the customer without any charge.

### Board Level

- Component fee: NEXCOM will only charge for main components, such as SMD chip, BGA chip, etc. Passive components will be repaired for free, ex: resistors, capacitors.
- If RMA goods can not be repaired, NEXCOM will return it to the customer without any charge.

## Warnings

Read and adhere to all warnings, cautions, and notices in this guide and the documentation supplied with the chassis, power supply, and accessory modules. If the instructions for the chassis and power supply are inconsistent with these instructions or the instructions for accessory modules, contact the supplier to find out how you can ensure that your computer meets safety and regulatory requirements.

## Cautions

Electrostatic discharge (ESD) can damage system components. Do the described procedures only at an ESD workstation. If no such station is available, you can provide some ESD protection by wearing an antistatic wrist strap and attaching it to a metal part of the computer chassis.

## Safety Information

Before installing and using the device, note the following precautions:

- Read all instructions carefully.
- Do not place the unit on an unstable surface, cart, or stand.
- Follow all warnings and cautions in this manual.
- When replacing parts, ensure that your service technician uses parts specified by the manufacturer.
- Avoid using the system near water, in direct sunlight, or near a heating device.
- The load of the system unit does not solely rely for support from the rackmounts located on the sides. Firm support from the bottom is highly necessary in order to provide balance stability.
- The computer is provided with a battery-powered real-time clock circuit. There is a danger of explosion if battery is incorrectly replaced. Replace only with the same or equivalent type recommended by the manufacturer. Discard used batteries according to the manufacturer's instructions.

## Installation Recommendations

Ensure you have a stable, clean working environment. Dust and dirt can get into components and cause a malfunction. Use containers to keep small components separated.

Adequate lighting and proper tools can prevent you from accidentally damaging the internal components. Most of the procedures that follow require only a few simple tools, including the following:

- A Philips screwdriver
- A flat-tipped screwdriver
- A grounding strap
- An anti-static pad

Using your fingers can disconnect most of the connections. It is recommended that you do not use needle-nose pliers to disconnect connections as these can damage the soft metal or plastic parts of the connectors.



## Safety Precautions

1. Read these safety instructions carefully.
2. Keep this User Manual for later reference.
3. Disconnect this equipment from any AC outlet before cleaning. Use a damp cloth. Do not use liquid or spray detergents for cleaning.
4. For plug-in equipment, the power outlet socket must be located near the equipment and must be easily accessible.
5. Keep this equipment away from humidity.
6. Put this equipment on a stable surface during installation. Dropping it or letting it fall may cause damage.
7. The openings on the enclosure are for air convection to protect the equipment from overheating. **DO NOT COVER THE OPENINGS.**
8. Make sure the voltage of the power source is correct before connecting the equipment to the power outlet.
9. Place the power cord in a way so that people will not step on it. Do not place anything on top of the power cord. Use a power cord that has been approved for use with the product and that it matches the voltage and current marked on the product's electrical range label. The voltage and current rating of the cord must be greater than the voltage and current rating marked on the product.
10. All cautions and warnings on the equipment should be noted.
11. If the equipment is not used for a long time, disconnect it from the power source to avoid damage by transient overvoltage.
12. Never pour any liquid into an opening. This may cause fire or electrical shock.
13. Never open the equipment. For safety reasons, the equipment should be opened only by skilled person.
14. If one of the following situations arises, get the equipment checked by service personnel:
  - a. The power cord or plug is damaged.
  - b. Liquid has penetrated into the equipment.
  - c. The equipment has been exposed to moisture.
  - d. The equipment does not work well, or you cannot get it to work according to the user's manual.
  - e. The equipment has been dropped and damaged.
  - f. The equipment has obvious signs of breakage.
15. Do not place heavy objects on the equipment.
16. The unit uses a three-wire ground cable which is equipped with a third pin to ground the unit and prevent electric shock. Do not defeat the purpose of this pin. If your outlet does not support this kind of plug, contact your electrician to replace your obsolete outlet.
17. **CAUTION: DANGER OF EXPLOSION IF BATTERY IS INCORRECTLY REPLACED. REPLACE ONLY WITH THE SAME OR EQUIVALENT TYPE RECOMMENDED BY THE MANUFACTURER. DISCARD USED BATTERIES ACCORDING TO THE MANUFACTURER'S INSTRUCTIONS.**

“ATTENTION: Risque d'explosion si la batterie est remplacée par un type incorrect. Mettre au rebus les batteries usagées selon les instructions.”
18. This equipment is not suitable for use in locations where children are likely to be present.

Cet équipement ne convient pas à une utilisation dans des lieux pouvant accueillir des enfants.
19. Suitable for installation in Information Technology Rooms in accordance with Article 645 of the National Electrical Code and NFPA 75.

Peut être installé dans des salles de matériel de traitement de l'information conformément à l'article 645 du National Electrical Code et à la NFPA 75.
20. Use certified and rated Laser Class I for Optical Transceiver product.

## Technical Support and Assistance

1. For the most updated information of NEXCOM products, visit NEXCOM's website at [www.nexcom.com](http://www.nexcom.com).
2. For technical issues that require contacting our technical support team or sales representative, please have the following information ready before calling:
  - Product name and serial number
  - Detailed information of the peripheral devices
  - Detailed information of the installed software (operating system, version, application software, etc.)
  - A complete description of the problem
  - The exact wordings of the error messages

### Warning!

1. Handling the unit: carry the unit with both hands and handle it with care.
2. Maintenance: to keep the unit clean, use only approved cleaning products or clean with a dry cloth.

## Conventions Used in this Manual



### Warning:

Information about certain situations, which if not observed, can cause personal injury. This will prevent injury to yourself when performing a task.



### Caution:

Information to avoid damaging components or losing data.



### Note:

Provides additional information to complete a task easily.

## Global Service Contact Information

### Headquarters

#### **NEXCOM International Co., Ltd.**

9F, No. 920, Chung-Cheng Rd.,  
ZhongHe District, New Taipei City, 23586,  
Taiwan, R.O.C.

Tel: +886-2-8226-7786

Fax: +886-2-8226-7782

[www.nexcom.com](http://www.nexcom.com)

### Asia

#### Taiwan

#### **NexAIoT Co., Ltd.**

#### **Taipei Office**

13F, No.920, Chung-Cheng Rd.,  
ZhongHe District,  
New Taipei City, 23586, Taiwan, R.O.C.

Tel: +886-2-8226-7796

Fax: +886-2-8226-7792

Email: [sales@nexcom.com.tw](mailto:sales@nexcom.com.tw)

[www.nexcom.com.tw](http://www.nexcom.com.tw)

#### **NexAIoT Co., Ltd.**

#### **Taichung Office**

16F, No.250, Sec. 2, Chongde Rd.,  
Beitun Dist.,

Taichung City 406, R.O.C.

Tel: +886-4-2249-1179

Fax: +886-4-2249-1172

Email: [sales@nexcom.com.tw](mailto:sales@nexcom.com.tw)

[www.nexcom.com.tw](http://www.nexcom.com.tw)

#### **NexCOBOT Taiwan Co., Ltd.**

13F, No.916, Chung-Cheng Rd.,  
ZhongHe District,  
New Taipei City, 23586, Taiwan, R.O.C.

Tel: +886-2-8226-7796

Fax: +886-2-8226-7792

Email: [sales@nexcom.com.tw](mailto:sales@nexcom.com.tw)

[www.nexcom.com.tw](http://www.nexcom.com.tw)

#### **GreenBase Technology Corp.**

13F, No.922, Chung-Cheng Rd.,  
Zhonghe Dist.,  
New Taipei City, 23586, Taiwan, R.O.C.

Tel: +886-2-8226-7786

Fax: +886-2-8226-7900

Email: [sales@nexcom.com.tw](mailto:sales@nexcom.com.tw)

[www.nexcom.com.tw](http://www.nexcom.com.tw)

### China

#### **NEXSEC Incorporated**

Floor 5, No.4, No.7 fengxian middle Rd.,  
(Beike Industrial Park), Haidian District,  
Beijing, 100094, China

Tel: +86-10-5704-2680

Fax: +86-10-5704-2681

Email: [sales@nexcom.cn](mailto:sales@nexcom.cn)

[www.nexcom.cn](http://www.nexcom.cn)

**NEXCOM Shanghai**

Room 603/604, Huiyinmingzun Plaza Bldg., 1,  
No. 609, Yunlin East Rd.,  
Shanghai, 200062, China  
Tel: +86-21-5278-5868  
Fax: +86-21-3251-6358  
Email: sales@nexcom.cn  
www.nexcom.cn

**NEXCOM Surveillance Technology Corp.**

Floor 5, Building C, ZhenHan Industrial Zone,  
GanKeng Community, Buji Street,  
LongGang District,  
ShenZhen, 518112, China  
Tel: +86-755-8364-7768  
Fax: +86-755-8364-7738  
Email: steveyang@nexcom.com.tw  
www.nexcom.cn

**NEXCOM United System Service**

Room 603/604, Huiyinmingzun Plaza Bldg. 1,  
No. 609, Yunlin East Rd.,  
Shanghai, 200062, China  
Tel: +86-21-5278-5868  
Fax: +86-21-3251-6358  
Email: renwang@nexcom.com.tw  
www.nexcom.cn

**NEXGOL**

1st Floor, Building B4, Electronic 2nd Area,  
(Phoenix Lake Industrial Park), Yongchuan Dist.,  
Chongqing City, 402160, China  
Tel: +86-23-4960-9080  
Fax: +86-23-4966-5855  
Email: sales@nexcobot.com  
www.nexgol.com/NexGoL

**Beijing NexGemo Technology Co.,Ltd.**

5th Floor, Gemotech Building, No.1, Development Rd.,  
Changping International Information Industry Base,  
Changping District,  
Beijing, 102206, China  
Tel: +86-10-8190-9399  
Fax: +86-10-8190-9456

**Japan****NEXCOM Japan**

9F, Tamachi Hara Bldg.,  
4-11-5, Shiba Minato-ku,  
Tokyo, 108-0014, Japan  
Tel: +81-3-5419-7830  
Fax: +81-3-5419-7832  
Email: sales@nexcom-jp.com  
www.nexcom-jp.com

**Europe****United Kingdom  
NEXCOM EUROPE**

10 Vincent Avenue,  
Crownhill Business Centre,  
Milton Keynes, Buckinghamshire  
MK8 0AB, United Kingdom  
Tel: +44-1908-267121  
Fax: +44-1908-262042  
Email: sales.uk@nexcom.eu  
www.nexcom.eu

**America****USA  
NEXCOM USA**

46665 Fremont Blvd,  
Fremont CA 94538, USA  
Tel: +1-510-656-2248  
Fax: +1-510-656-2158  
Email: sales@nexcom.com  
www.nexcomusa.com

## Package Contents

Before continuing, verify that the DFA1163 package that you received is complete. Your package should have all the items listed in the following table.

Item	Part Number	Name	Description	Qty
1	50311F0100X00	(H)Round Head Screw w/Spring+Flat Washer Long Fei:P3x6L	P3x6 iso/SW6x0.5 NI	6
2	50311F0111X00	(H)Flat Head Screw Long Fei:F3x5ISO+Nylok Black	F3x5 Black Nylok	15
3	50311F0144X00	I Head Screw Long Fei:	M3x4mm NI Nylok	4
4	50311F0162X00	(H)Round Head Screw GW/Washer Long Fei	P4x8 iso/w NI	1
5	50311F0181X00	(H)P Head Screw Long Fei	M3X8L Nilok	5
6	50311F0245X00	Flat Head Screw Long Fei	F4X8L-Tap Cut Black	8
7	50311T0050X00	I Head Screw Long Fei	ISO I3x8mm Black	2
8	50322C0028X00	NXG50 NUT S.C.:GE4N2SN10800 (Must be used with DC JACK)	10.00x(5/16x32W) T=2.10mm	1
9	50333F0008X00	NXG50 Washer S.C.:GJ4W1SN10800 (Must be used with DC JACK)	10.10x8.10mm T=0.3mm	1
10	50344C0112X00	Copper Post Long Fei:Copper Post 8x5xM3	With Male/Female(Female)8mmx(Male)5mmxM3	5
11	5044440031X00	Rubber Foot Kang Yang:RF20-5-4P	19.8x18x5.0mm	4
12	50501A1295X00	(N)Chassis for DFA1163M VER:A CHYUAN-JYH	254x226x44mm SGCC T=0.8mm Painting:PANTONE 8403C	1
13	5050200114X00	Fan for vDNA1160 VER:A SUN TAI:AD204020MBPA08	40x40x20mm 8000RPM 12V 2510 4Pin L=100mm	2
14	5060200394X00	Thermal Pad for vDNA1160 VER:A E-LIN	31x25x1mm K=15W/m-k	1
15	5060600038X00	NICE3120 Diamter Hole Plugs 康揚:MHD-7	7.2xDiameter:9xH:5.7mm Black	7
16	5061711373X00	(N)SFP+ 2x1 Cage Chant Sincere:902GHB1BCTA2N1A3	w/EMI & Light Pipe Press-fit Type 63.25x14.75x26.95mm	1
17	5061711600X00	(N)54V Power Cover for DFA1163M VER:A CHYUAN-JYH	30.8x24x19mm SGCC T=1.0mm	1
18	5061711601X00	(N)Fan Bracket for DFA1163M VER:A CHYUAN-JYH	42x40x15.8mm SGCC T=1.0mm	2
19	60110A0235X00	Pizza Box for AGX5000 Switch PCB VER:A YI GIA	333x264x82mm B Flute 14kg	1
20	60111A0457X00	Outside Carton for NPA-1610-M (B3) VER:A YI GI	O/D:380x320x232mm AB Flute 18kg	1
21	6012200052X00	PE Zipper Bag #8 炎洲:印刷由任袋8號	170x240mm,w/China RoHS Symbol	1
22	6012200062X00	PE Bag for DNA730/840 PANADVANCE	350x330mm T:0.08mm With RoHS Symbol	1

## Package Contents Cont.

Before continuing, verify that the DFA1163 package that you received is complete. Your package should have all the items listed in the following table.

Item	Part Number	Name	Description	Qty
23	6013301556X00	EPE for DFA1163 VER:A SENTENEL	304x198x101mm	2
24	6019900289X00	Paper Plate for NSK6301 4 IN 1 Pack VER:A YI GIA	324x254mm AB Flute 14kg	1
25	6019900290X00	Paper Partition for NSK6301 4 IN 1 PACK VER:A YI GIA	253x151mm B Flute 14kg	1
26	6019900291X00	Carton Lining for NSK6301 4 IN 1 PACK VER:A YI GIA	577x330mm B Flute 14kg	1
27	6023309081X00	Cable EDI:232091081804-RS	COM Port. DB9 Female To RJ45 8P8C L:1800mm	1
28	7400090005X00	Power Adapter DELTA:DPS-90AB-3 D	DC 90W 12V/7.5A 150x60x30.5mm	1
29	CE01000338X00	C Eeprom Of I211(Intel) VER:0.6 Color:A	File:I211_DNB1160.txt	1
30	50311F0100X00	(H)Round Head Screw w/Spring+Flat Washer Long Fei:P3x6L	P3x6 iso/SW6x0.5 NI	6
31	50311F0111X00	(H)Flat Head Screw Long Fei:F3x5ISO+Nylok Black	F3x5 Black Nylok	15
32	50311F0144X00	I Head Screw Long Fei:	M3x4mm NI Nylok	4
33	50311F0162X00	(H)Round Head Screw GW/Washer Long Fei	P4x8 iso/w NI	1
34	50311F0181X00	(H)P Head Screw Long Fei	M3X8L Nilok	5
35	50311F0245X00	Flat Head Screw Long Fei	F4X8L-Tap Cut Black	8
36	50311T0050X00	I Head Screw Long Fei	ISO I3x8mm Black	2
37	50322C0028X00	NXG50 Nut S.C.:GE4N2SN10800 (Must be used with DC JACK)	10.00x(5/16x32W) T=2.10mm	1
38	50333F0008X00	NXG50 Washer S.C.:GJ4W1SN10800 (Must be used with DC JACK)	10.10x8.10mm T=0.3mm	1
39	50344C0112X00	Copper Post Long Fei:Copper Post 8x5xM3	With Male/Female(Female)8mmx(Male)5mmxM3	5
40	5044440031X00	Rubber Foot Kang Yang:RF20-5-4P	19.8x18x5.0mm	4
41	50501A1295X00	(N)Chassis for DFA1163M VER:A CHYUAN-JYH	254x226x44mm SGCC T=0.8mm PAINTING:PANTONE 8403C	1
42	5050200114X00	Fan for vDNA1160 VER:A SUN TAI:AD204020MBPA08	40x40x20mm 8000RPM 12V 2510 4Pin L=100mm	2
43	5060200394X00	Thermal Pad for vDNA1160 VER:A E-LIN	31x25x1mm K=15W/m-k	1
44	5060600038X00	NICE3120 Diameter Hole Plugs 康揚:MHD-7	7.2xDiameter:9xH:5.7mm Black	7

## Package Contents

Before continuing, verify that the DFA1163 package that you received is complete. Your package should have all the items listed in the following table.

Item	Part Number	Name	Description	Qty
45	5061711373X00	(N)SFP+ 2x1 Cage Chant Sincere:902GHB1BCTA2N1A3	w/EMI & Light Pipe Press-fit Type 63.25x14.75x26.95mm	1
46	5061711600X00	(N)54V Power Cover for DFA1163M VER:A CHYUAN-JYH	30.8x24x19mm SGCC T=1.0mm	1
47	5061711601X00	(N)Fan Bracket for DFA1163M VER:A CHYUAN-JYH	42x40x15.8mm SGCC T=1.0mm	2
48	60110A0235X00	Pizza Box for AGX5000 Switch PCB VER:A YI GIA	333x264x82mm B Flute 14kg	1
49	60111A0457X00	Outside Carton for NPA-1610-M (B3) VER:A YI GIA	O/D:380x320x232mm AB Flute 18kg	1
50	6012200052X00	PE Zipper Bag #8 炎洲:印刷由任袋8號	170x240mm,w/China RoHS Symbol	1
51	6012200062X00	PE Bag for DNA730/840 Panadvance	350x330mm T:0.08mm With RoHS Symbol	1
52	6013301556X00	EPE for DFA1163 VER:A SENTENEL	304x198x101mm	2
53	6019900289X00	Paper Plate for NSK6301 4 IN 1 Pack VER:A YI GIA	324x254mm AB Flute 14kg	1
54	6019900290X00	Paper Partition for NSK6301 4 IN 1 Pack VER:A YI GI	253x151mm B Flute 14kg	1
55	6019900291X00	Carton Lining for NSK6301 4 IN 1 Pack VER:A YI GIA	577x330mm B Flute 14kg	1
56	6023309081X00	Cable EDI:232091081804-RS	COM Port. DB9 Female to RJ45 8P8C L:1800mm	1
57	7400090005X00	Power Adapter Delta:DPS-90AB-3 D	DC 90W 12V/7.5A 150x60x30.5mm	1

## Ordering Information

The following below provides ordering information for DFA1163.

- **DFA 1163 (P/N: 10FA0116300X0)**

Intel Atom® Processor C3558R, BGA type 4 cores/2.4 GHz,  
2 x DDR4-2400 DIMM ECC memory, max. 64 GB

- **DFA 1163A (P/N: 10FA0116301X0)**

Intel Atom® Processor C3758R, BGA type 8 cores/2.4 GHz,  
2 x DDR4-2400 DIMM ECC memory, max. 64 GB

- **DFA 1163M (P/N: 10FA0116302X0)**

Intel Atom® Processor C3758R, BGA type 8 cores/2.4 GHz,  
2 x DDR4-2400 DIMM ECC memory, max. 64 GB, TSN support,  
5G FR1/FR2 support



# CHAPTER 1: PRODUCT INTRODUCTION

## Overview



## Key Features

- Intel Atom® processor C3000R
- 2 x DDR4 ECC RDIMM/UDIMM
- 1 x 10GbE SFP+ port
- 12 x RJ45 ports (with optional PoE+ support)
- Supports Wi-Fi 6
- Supports 4G LTE and 5G FR1 SA/NSA modes
- Supports 5G FR2 NSA mode (DFA 1163M only)
- Supports TSN (DFA 1163M only)

## Hardware Specifications

### Main Board

- Intel Atom® processor C3000R
  - Intel Atom® processor C3558R, BGA type, 4 cores/  
2.4 GHz for DFA 1163
  - Intel Atom® processor C3758R, BGA type, 8 cores/  
2.4 GHz for DFA 1163A
  - Intel Atom® processor C3758R, BGA type, 8 cores/  
2.4 GHz for DFA 1163M
- TPM 2.0 onboard

### Main Memory

- 2 x DDR4-2400 ECC RDIMM/UDIMM, up to 64GB

### Storage

- 1 x 8G onboard eMMC
- 1 x PCIe3x 4 M.2 2280 Key M SSD

### Interface External

- Button: power and reset
- LAN ports LED indicators: active/link speed
- 8 x LED indicators: power/PoE/MGMT/SSD/WLAN/5G LTE
- 1 x USB 3.0 connector combined with RJ45 console port
- 1 x USB 3.0 connector combined with RJ45 management port
- 1 x Dual Micro SIM slot
- 2 x 2.5GbE RJ45 ports ports (with optional PoE+ support)
- 2 x 1GbE RJ45 ports ports (with optional PoE+ support)
- 8 x 1GbE RJ45 Switch ports (with optional PoE+ support)
- 1 x 1GbE SFP port

- 1 x 10GbE SFP+ port
- 2 x Fixed smart fans
- 2 x Power inlets (1 x 12V, 1 x 54V)
- 6 x Antenna holes (4 x for 4G LTE/5G antennas, 2 x for Wi-Fi 6 antennas)

### Interface-Internal

- 1 x M.2 3080 Key M slot for Wi-Fi 6 module
- 1 x M.2 3042/3052 Key B slot for 4G LTE/5G module

### Power Input

- 65W 12V AC power adapter
- 280W 54V PoE power adapter (optional)

### Dimensions and Weight

- Chassis dimension (mm): 253.5mm x 226mm x 44mm (W x D x H)
- Package dimension (mm): 380mm x 320mm x 232mm (W x D x H)
- Without package: 3.81 kg
- With package: 4.98 kg

### Environment

- Operating temperature: 0°C~40°C
- Storage temperature: -20°C~80°C
- Relative humidity: 10%~90% non-condensing

### Certifications

- CE/FCC Class B

# Knowing Your DFA1163

## Front Panel

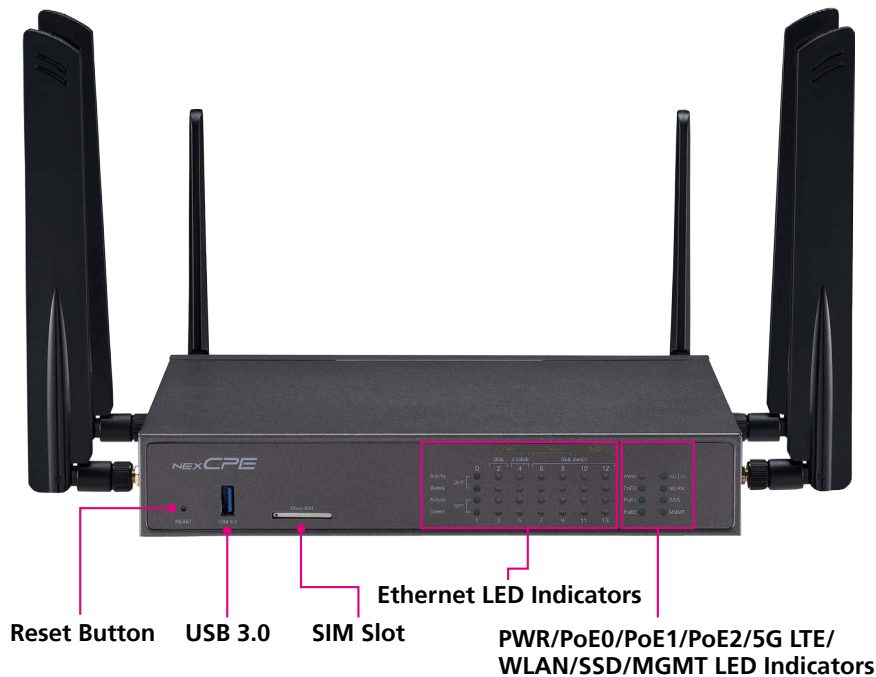

### Reset Button

Press to restart the system.

### USB 3.0 Ports

Used to connect USB 3.0/2.0 devices.

### SIM Slot

Used to insert a SIM card.

### Ethernet LED Indicators

Displays Ethernet activity

Link activity: Green for link; Flashing green for activity.

GbE speed: Green for 1G; Amber for 100M; Off for 10M

2.5GbE: Green for 2.5G; Amber for 1G; Off for 100M/10M

SFP: Green for 1G; Off for others

SFP+: Green for 10G; Off for others

### LED Indicators (PWR/PoE0/PoE1/PoE2/5G LTE/WLAN/SSD/MGMT)

Power LED: Green for on; Red for off

PoE0~2: Green for active; Off for inactive

5G LTE: Green for module installation; Off for module non-installation

WLAN: Green for module installation; Off for module non-installation

SSD: Green for active; Flashing green for data transferring; Off for inactive

MGMT: Green for active; Off for inactive

## Rear Panel

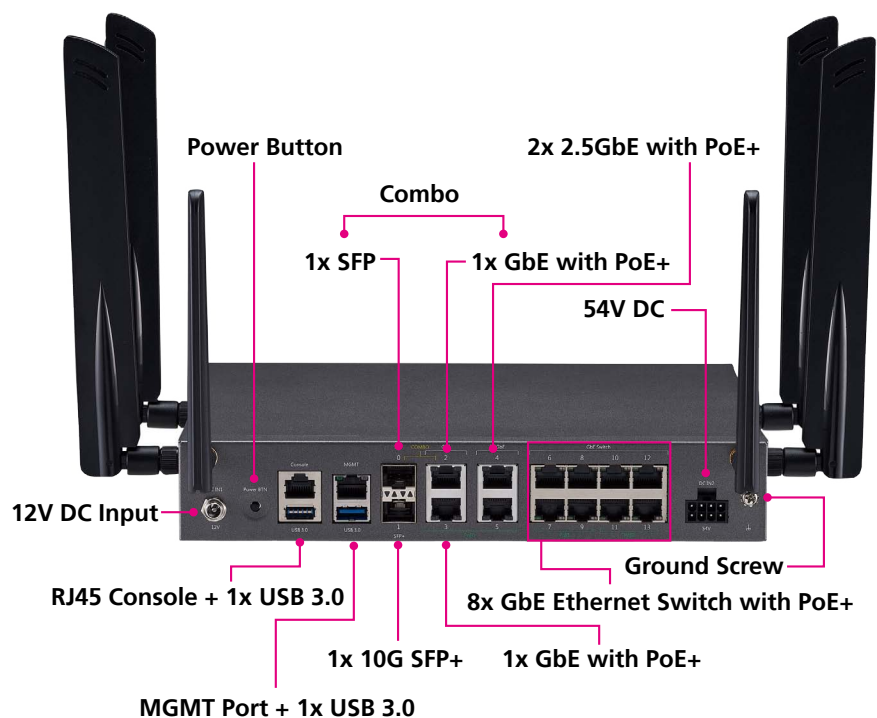

### 12V DC Input/54V DC Input

12V: Used to plug a DC power cord. (For x86 system)

54V: Used to plug a DC power cord. (For PoE)

### Power Button

Press to power-on or power-off the system.

### RJ45 Console Port

Used to connect to devices with RJ45 type console connection.

### USB 3.0 Ports

Used to connect USB 3.0/2.0 devices.

### MGMT Port

For the remote management and configuration of a networking device.

### SFP Port

Used to connect SFP transceivers/modules.

### Gigabit PoE Ports

Used to connect the system to Powered Device (PD) compliant devices, such as IP cameras.

### GbE Ethernet switch with PoE+

Used for connection with multiple network devices.

### Ground Screw

Used for chassis grounding.

### Antenna Holes

Used to mount and connect external antennas.

# Mechanical Dimensions

## DFA 1163

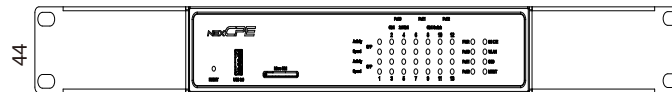
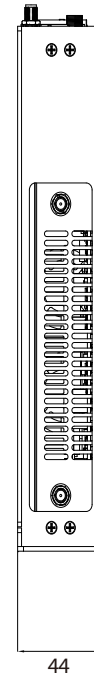
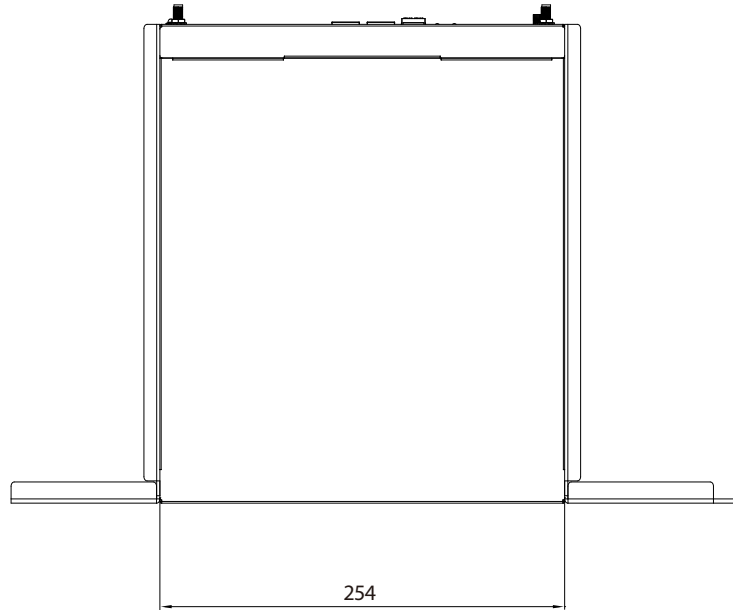
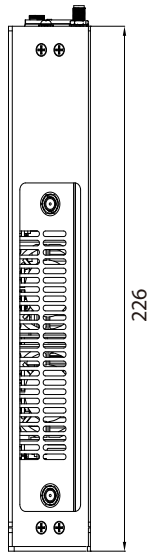
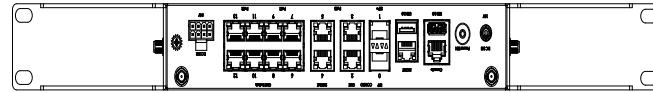

## CHAPTER 2: JUMPERS AND CONNECTORS

This chapter describes how to set the jumpers and connectors on the DFA1163 motherboard.

### Before You Begin

- Ensure you have a stable, clean working environment. Dust and dirt can get into components and cause a malfunction. Use containers to keep small components separated.
- Adequate lighting and proper tools can prevent you from accidentally damaging the internal components. Most of the procedures that follow require only a few simple tools, including the following:
  - A Philips screwdriver
  - A flat-tipped screwdriver
  - A set of jewelers screwdrivers
  - A grounding strap
  - An anti-static pad
- Using your fingers can disconnect most of the connections. It is recommended that you do not use needle-nosed pliers to disconnect connections as these can damage the soft metal or plastic parts of the connectors.
- Before working on internal components, make sure that the power is off. Ground yourself before touching any internal components, by touching a metal object. Static electricity can damage many of the electronic components. Humid environments tend to have less static electricity than

dry environments. A grounding strap is warranted whenever danger of static electricity exists.

### Precautions

Computer components and electronic circuit boards can be damaged by discharges of static electricity. Working on computers that are still connected to a power supply can be extremely dangerous.

Follow the guidelines below to avoid damage to your computer or yourself:

- Always disconnect the unit from the power outlet whenever you are working inside the case.
- If possible, wear a grounded wrist strap when you are working inside the computer case. Alternatively, discharge any static electricity by touching the bare metal chassis of the unit case, or the bare metal body of any other grounded appliance.
- Hold electronic circuit boards by the edges only. Do not touch the components on the board unless it is necessary to do so. Don't flex or stress the circuit board.
- Leave all components inside the static-proof packaging that they shipped with until they are ready for installation.
- Use correct screws and do not over tighten screws.

## Jumper Settings

A jumper is the simplest kind of electric switch. It consists of two metal pins and a cap. When setting the jumpers, ensure that the jumper caps are placed on the correct pins. When the jumper cap is placed on both pins, the jumper is short. If you remove the jumper cap, or place the jumper cap on just one pin, the jumper is open.

Refer to the illustrations below for examples of what the 2-pin and 3-pin jumpers look like when they are short (on) and open (off).

Two-Pin Jumpers: Open (Left) and Short (Right)

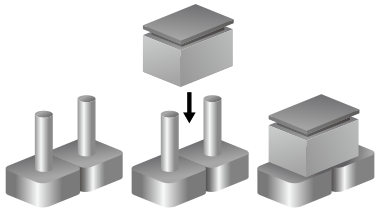

Three-Pin Jumpers: Pins 1 and 2 are Short

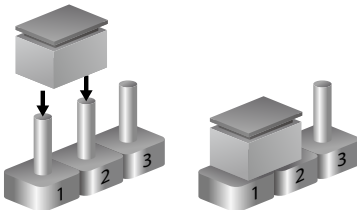

# Locations of the Jumpers and Connectors

The figure below shows the location of the jumpers and connectors.

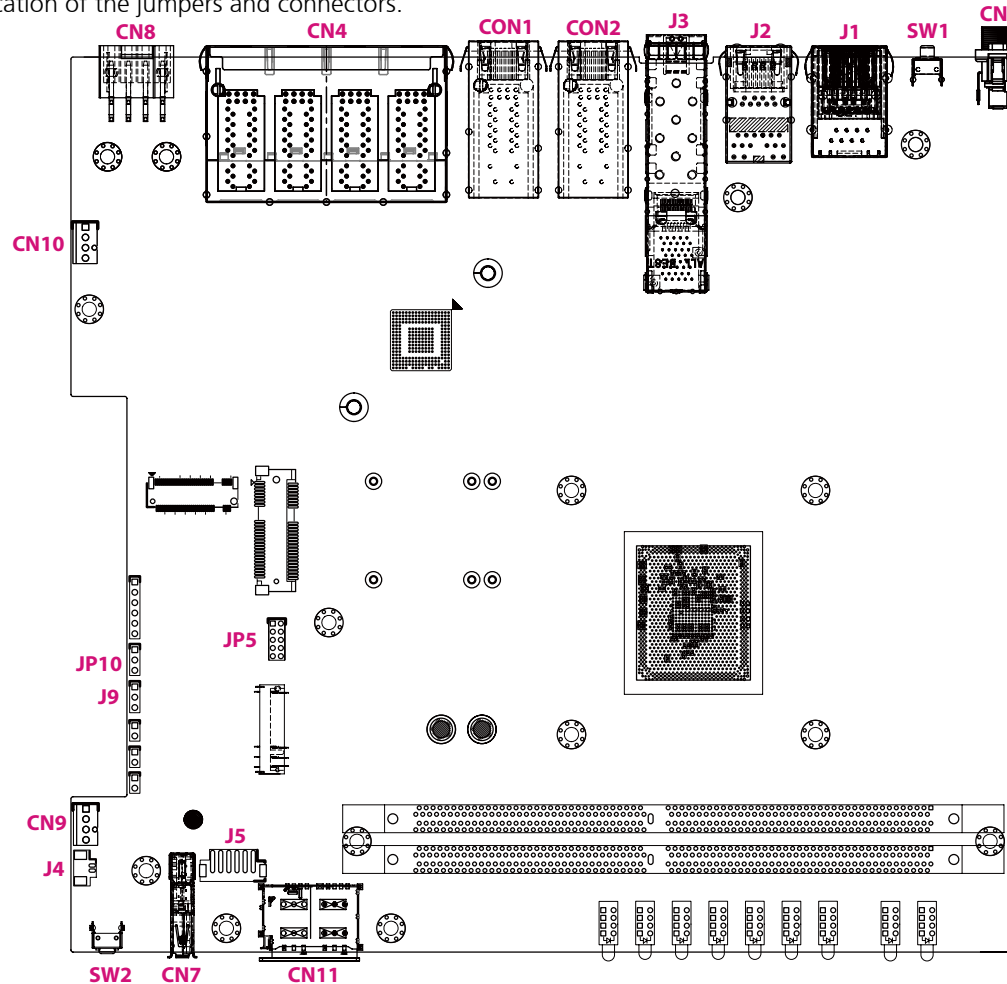



## Jumpers

### RTC Clear

Connector type: 1x3 3-pin header  
Connector location: JP9



Pin	Description
1-2	Normal
2-3	Clear CMOS

### PMC Clear

Connector type: 1x3 3-pin header  
Connector location: JP10

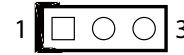

Pin	Description
1-2	Normal
2-3	Clear PMC

## Connector Pin Definitions

### External I/O Interfaces

#### DC-12V Power Connector

Connector type: 12V for x86 system

Connector location: CN1

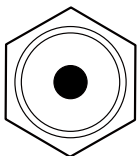

Pin	Description
1	GND
2	GND
3	DC_IN

#### +54V DC IN

Connector type: 54V for PoE

Connector location: CN8

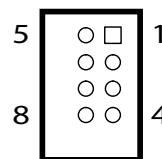

Pin	Signal	Pin	Signal
1	Vmain_54V	5	NA-
2	POE_AGND	6	NA
3	NA	7	POE_AGND
4	P54V_PG	8	POE_AGND

## System Power Button

Connector location: SW1

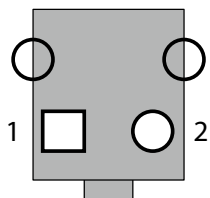

Pin	Function
2	GND
1	PWR_BTN_CAL_N

## USB 3.0

Connector type: USB 3.0

Connector location: CN7

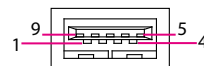

Pin	Signal	Pin	Signal
1	P5V_USB	6	USB3_RX_D0+
2	USB2_P0-	7	GND
3	USB2_P0+	8	USB3_TX_D0-
4	GND	9	USB3_TX_D0+
5	USB3_RX_D0-		

## LAN Connector

Connector type: GbE Ethernet switch with PoE+

Connector location: CN4

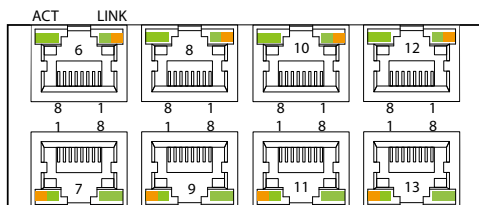

Pin	Signal	Pin	Signal
A1	P_LAN2_MDI0P	B1	P_LAN1_MDI0P
A2	P_LAN2_MDI0N	B2	P_LAN1_MDI0N
A3	P_LAN2_MDI1P	B3	P_LAN1_MDI1P
A4	P_LAN2_MDI1N	B4	P_LAN1_MDI1N
A5	P_LAN2_MDI2P	B5	P_LAN1_MDI2P
A6	P_LAN2_MDI2N	B6	P_LAN1_MDI2N
A7	P_LAN2_MDI3P	B7	P_LAN1_MDI3P
A8	P_LAN2_MDI3N	B8	P_LAN1_MDI3N
A9	GND	B9	GND
A10	GND	B10	GND
AL4	P3V3	BL4	P3V3
AL3	PORT2_ACT_N	BL3	PORT1_ACT_N
AL1	PORT2_L100_N	BL1	PORT1_L100_N
AL2	PORT2_L1000_N	BL2	PORT1_L1000_N
MH1	CGND	MH4	CGND
MH2	CGND	MH5	CGND
MH3	CGND	MH6	CGND

## LAN Connector

Connector type: 2.5GbE RJ45 port with PoE+

Connector location: CON1

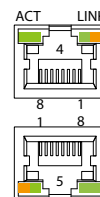

Pin	Signal	Pin	Signal
A1	LAN1_MDIN0	B1	LAN2_MDIN0
A2	LAN1_MDIP0	B2	LAN2_MDIP0
A3	LAN1_MDIN1	B3	LAN2_MDIN1
A4	LAN1_MDIP1	B4	LAN2_MDIP1
A5	LAN1_MDIN2	B5	LAN2_MDIN2
A6	LAN1_MDIP2	B6	LAN2_MDIP2
A7	LAN1_MDIN3	B7	LAN2_MDIN3
A8	LAN1_MDIP3	B8	LAN2_MDIP3
A9	GND	B9	GND
A10	GND	B10	GND
AL4	P3V3	BL4	P3V3
AL3	LAN1_LED_ACT_N	BL3	LAN2_LED_ACT_N
AL1	LAN1_LED_LINK1000_N	BL1	LAN1_LED_LINK1000_N
AL2	LAN1_LED_LINK2500_N	BL2	LAN2_LED_LINK2500_N

## LAN Connector

Connector type: SFP and 10G SFP+

Connector location: J3

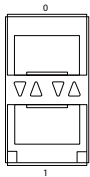

Pin	Signal	Pin	Signal
T1	GND	T20	GND
T2	TxFault1	T19	1_SFP+_TD-
T3	TxDisable1	T18	1_SFP+_TD+
T4	P10G_Sda1	T17	GND
T5	P10G_Scl1	T16	3P3V_SFP1_T
T6	ModABS1_L	T15	3P3V_SFP1_R
T7	1_RS0	T14	GND
T8	RxLOS1	T13	1_SFP+_RD+
T9	1_RS1	T12	1_SFP+_RD-
T10	GND	T11	GND
L1	GND	L20	GND
L2	TxFault2	L19	2_SFP+_TD-
L3	TxDisable2	L18	2_SFP+_TD+
L4	P10G_Sda2	L17	GND

Pin	Signal	Pin	Signal
L5	P10G_Scl2	L16	3P3V_SFP2_T
L6	ModABS2_L	L15	3P3V_SFP2_R
L7	2_RS0	L14	GND
L8	RxLOS2	L13	2_SFP+_RD+
L9	2_RS1	L12	2_SFP+_RD-
L10	GND	L11	GND

## LAN Connector

Connector type: GbE with PoE+  
Connector location: CON2

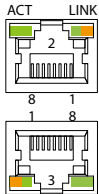

Pin	Signal	Pin	Signal
A1	Port3_TX0N	B1	LAN2_MDIN0
A2	Port3_TX0P	B2	LAN2_MDIP0
A3	Port3_TX1N	B3	LAN2_MDIN1
A4	Port3_TX1P	B4	LAN2_MDIP1
A5	Port3_TX2N	B5	LAN2_MDIN2
A6	Port3_TX2P	B6	LAN2_MDIP2
A7	Port3_TX3N	B7	LAN2_MDIN3
A8	Port3_TX3P	B8	LAN2_MDIP3
A9	GND	B9	GND
A10	GND	B10	GND
AL4	P3V3	BL4	P3V3
AL3	P1_LED2	BL3	P3_LED2
AL1	P1_LED1	BL1	P3_LED1
AL2	P1_LED0	BL2	P3_LED0

## Console Port & USB 3.0

Connector type: RJ45 console port & USB 3.0  
Connector location: J1

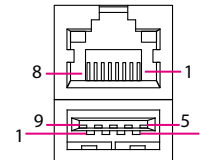

Pin	Signal	Pin	Signal
1	USB_PORT1_VBUS	P1	SP_RTS1_R
2	USB2_P1-	P2	SP_DTR1_R
3	USB2_P1+	P3	SP_TXD1_R
4	GND	P4	SP_DCD1_R
5	USB3_RX_D1-	P5	GND
6	USB3_RX_D1+	P6	SP_RXD1_R
7	GND	P7	SP_DSR1_R
8	USB3_TX_D1-	P8	SP_CTS1_CON
9	USB3_TX_D1+		

## MGMT Port & USB 3.0

Connector type: RJ45 management port & USB 3.0

Connector location: J2

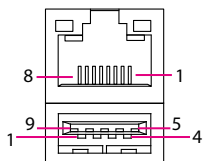

Pin	Signal	Pin	Signal
1	USB_PORT2_VBUS	11	LAN3_TX0P
2	USB2_P2-	12	LAN3_TX0N
3	USB2_P2+	13	LAN3_TX1P
4	GND	14	LAN3_TX1N
5	USB3_RX_D2-	15	LAN3_TX2P
6	USB3_RX_D2+	16	LAN3_TX2N
7	GND	17	LAN3_TX3P
8	USB3_TX_D2-	18	LAN3_TX3N
9	USB3_TX_D2+		
L1	LAN3_LED_LINK100#	L3	LAN3_LED_ACT#
L2	LAN3_LED_LINK1G#	L4	P3V3_STBY

## Internal Connectors

### Fan Connector

Connector type: 1x4 4-pin header

Connector location: CN9 & CN10

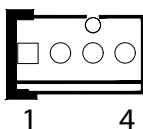

Pin	Description
1	GND
2	P12V
3	TACH
4	PWM

### GPIO

Connector type: 2x5 10-pin header

Connector location: JP5

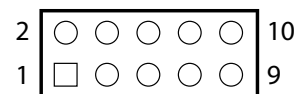

Pin	Signal	Pin	Signal
1	P5V	6	SIO_GPOUT2
2	GND	7	SIO_GPIN3
3	SIO_GPIN1	8	SIO_GPOUT3
4	SIO_GPOUT1	9	SIO_GPIN4
5	SIO_GPIN2	10	SIO_GPOUT4



## TPM

Connector type: 2x7 14-pin header

Connector location: TPM

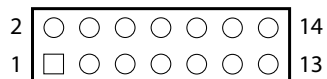

Pin	Signal	Pin	Signal
1	GND	8	LPC_LAD3
2	LPC_CLKOUT1_BK	9	GND
3	NC	10	LPC_LAD0
4	LPC_FRAME_N	11	LPC_SERIRQ
5	LPC_LAD2	12	P3V3
6	CPLD_TPM_PLTRST_N	13	GND
7	LPC_LAD1	14	GND

# Block Diagram

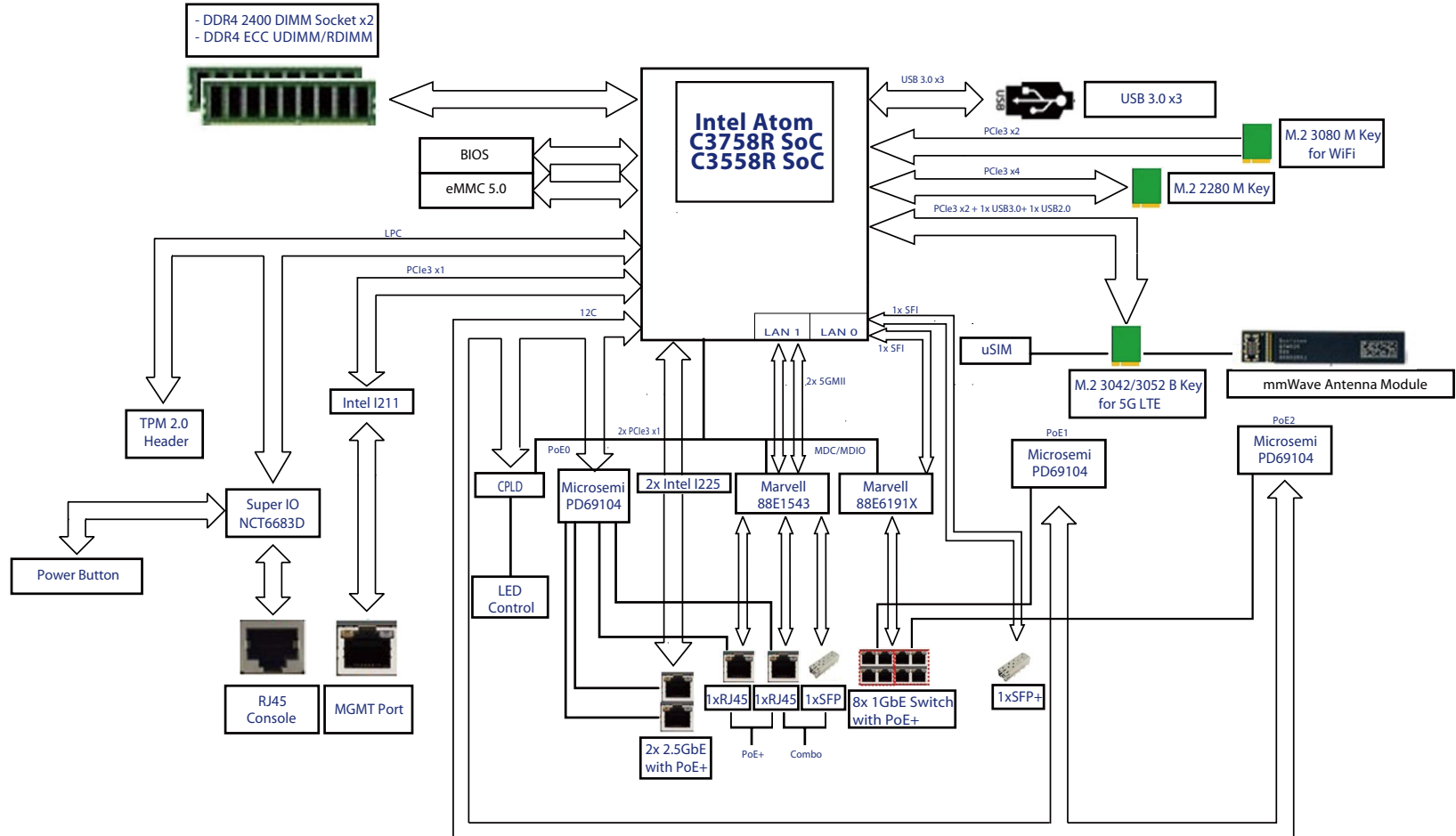

## CHAPTER 3: SYSTEM SETUP

### Removing the Chassis Cover



Prior to removing the chassis cover, make sure the unit's power is off and disconnected from the power sources to prevent electric shock or system damage.

1. The screws on the bottom and sides of the cover are used to secure the cover to the chassis. Remove these screws and put them in a safe place for later use.

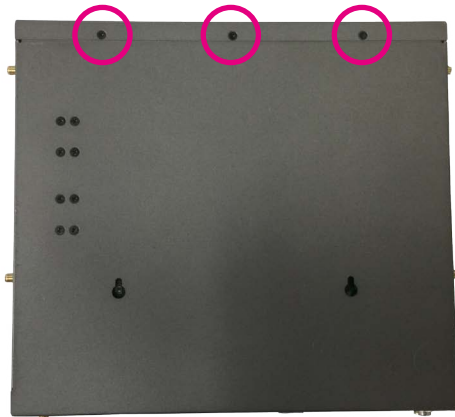

Screws on the bottom



Screws on the sides

2. With the screws removed, gently slide the cover outwards then lift up the cover to remove it.

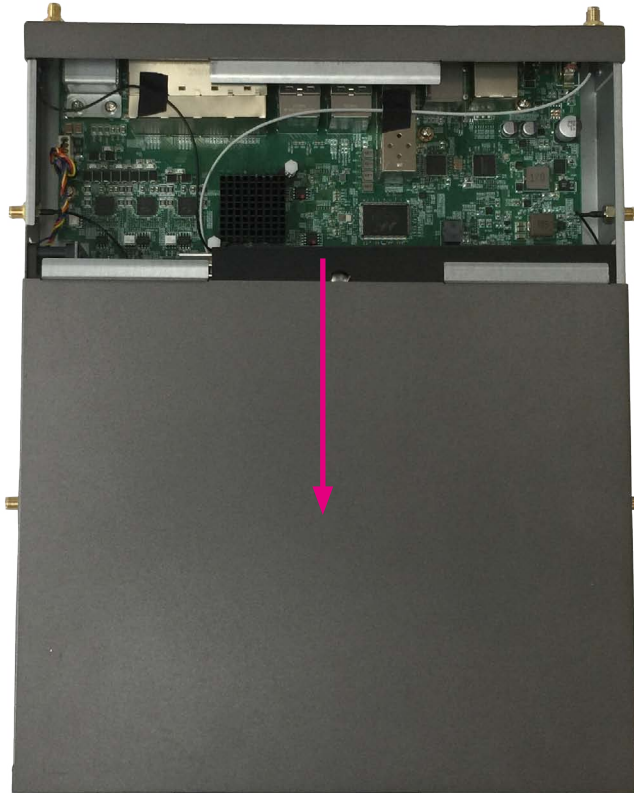

## Installing a DIMM Memory Module

1. Locate the DIMM socket on the motherboard and push the ejector tabs which are at the ends of the socket outward. This indicates that the socket is unlocked.
2. Seat the module vertically, pressing it down firmly until it is completely seated in the socket. The ejector tabs at the ends of the socket will automatically snap into the locked position to hold the module in place.

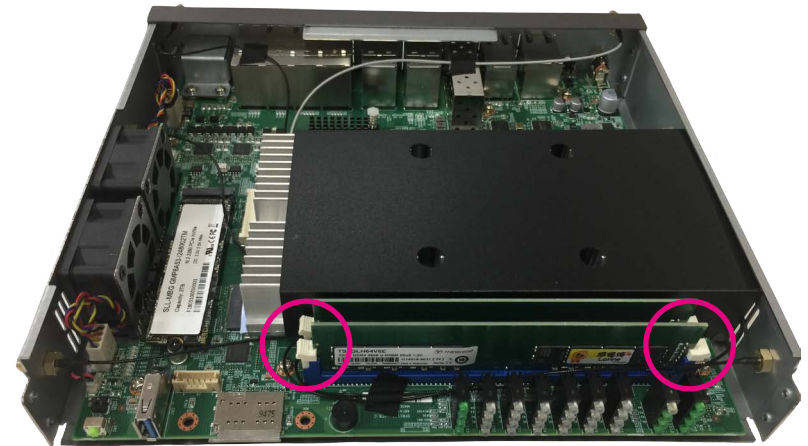
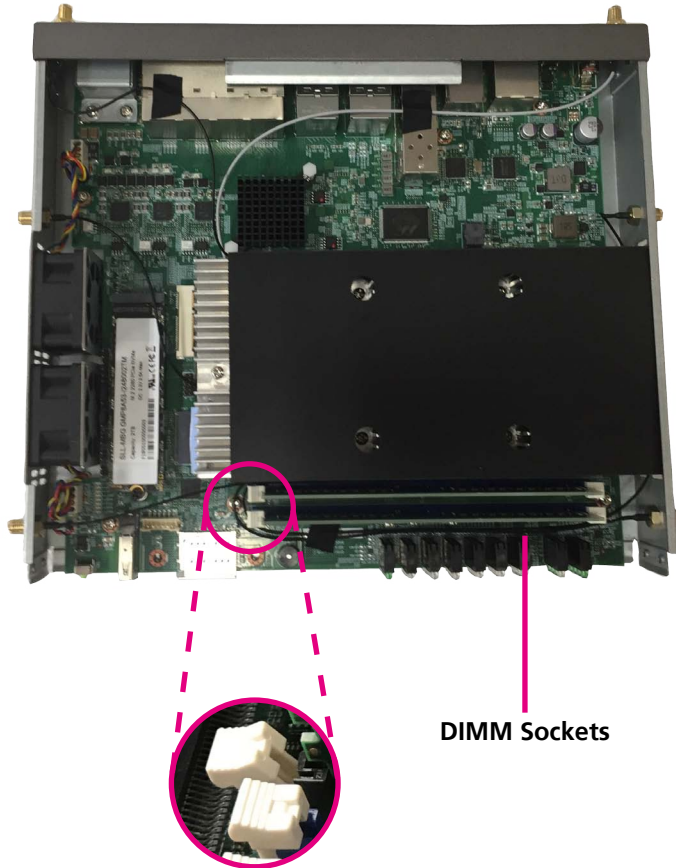

## Installing the M.2 Module

1. Locate the M.2 slot on the motherboard.

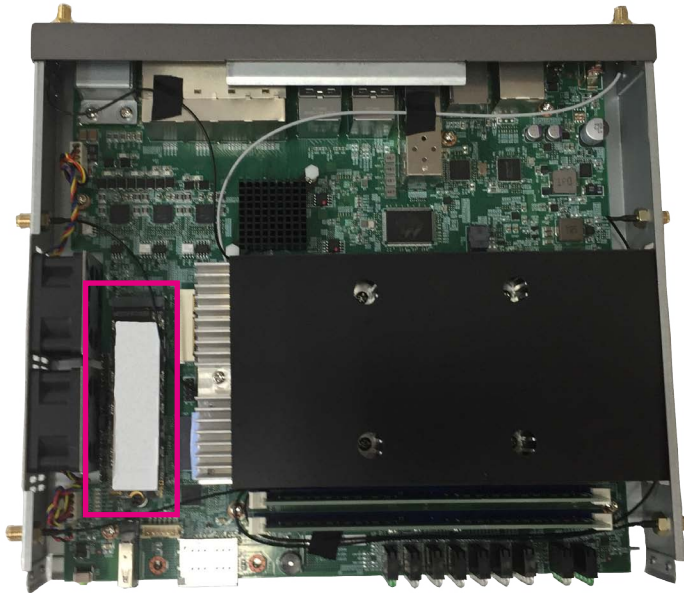

2. Insert the M.2 module into the M.2 slot at a 45 degrees angle until the gold-plated connector on the edge of the module completely disappears inside the slot. Push the M.2 module down and fasten the M.2 mounting screw into the mounting hole to secure the module.

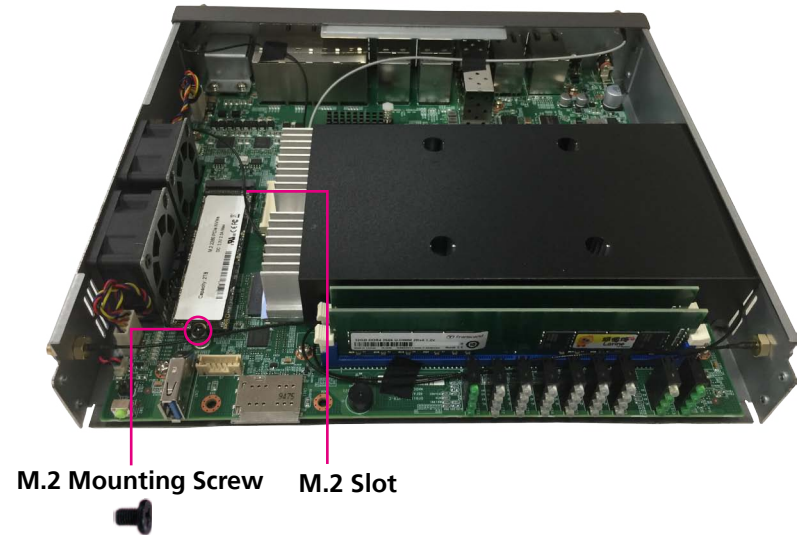

## Installing Both the 5G and Wi-Fi Module

1. Locate the 5G slot on the motherboard.

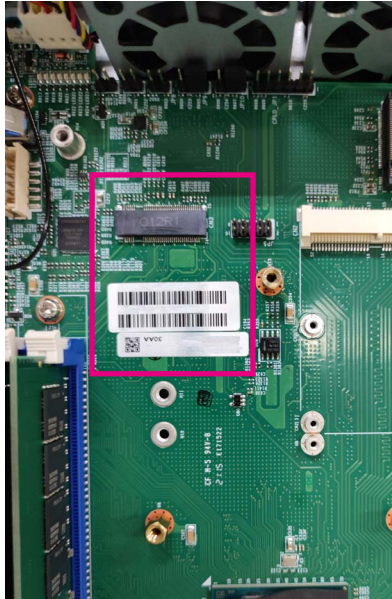

2. Insert the 5G module into the 5G slot at a 45 degrees angle until the gold-plated connector on the edge of the module completely disappears inside the slot. Push the 5G module down and fasten the mounting screw into the mounting hole to secure the module.

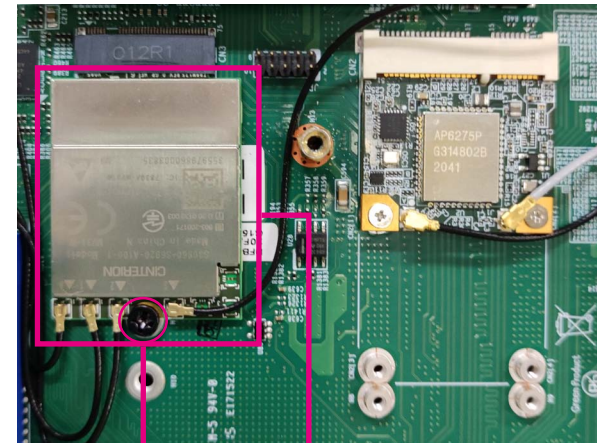

Mounting Screw 5G Module



3. Take out the thermal pad from the accessory bad and remove the release paper on both sides of the thermal pad. Fix the thermal pad in the center of the module.



4. Locate the Wi-Fi slot on the motherboard.

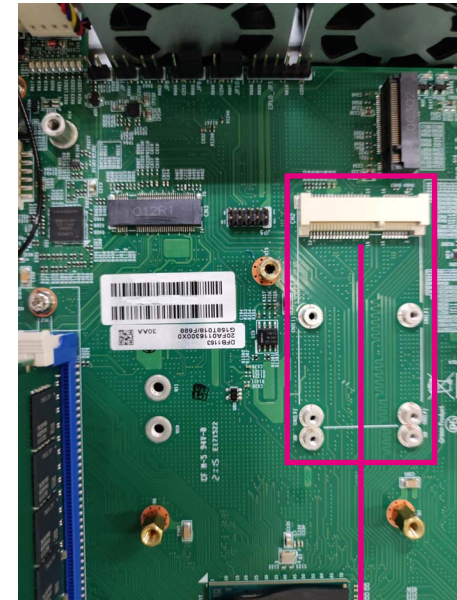

Wi-Fi Slot



5. Insert the Wi-Fi module into the Wi-Fi slot at a 45 degrees angle until the gold-plated connector on the edge of the module completely disappears inside the slot. Push the Wi-Fi module down and fasten a Wi-Fi mounting screw into the mounting hole to secure the module.

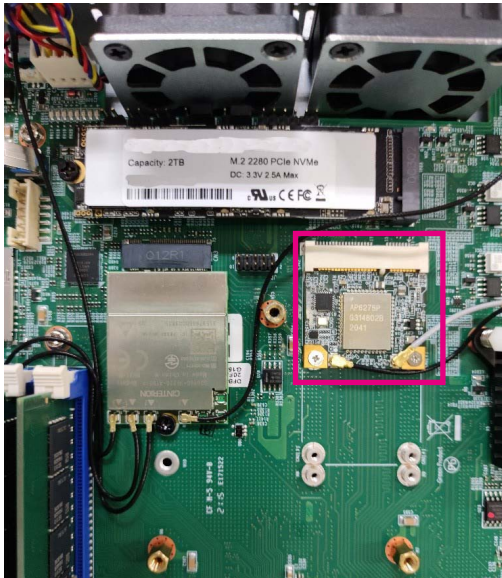

# CHAPTER 4: BIOS SETUP

This chapter describes how to use the BIOS setup program for DFA1163. The BIOS screens provided in this chapter are for reference only and may change if the BIOS is updated in the future.

To check for the latest updates and revisions, visit the NEXCOM website at [www.nexcom.com.tw](http://www.nexcom.com.tw).

## About BIOS Setup

The BIOS (Basic Input and Output System) Setup program is a menu driven utility that enables you to make changes to the system configuration and tailor your system to suit your individual work needs. It is a ROM-based configuration utility that displays the system's configuration status and provides you with a tool to set system parameters.

These parameters are stored in non-volatile battery-backed-up CMOS RAM that saves this information even when the power is turned off. When the system is turned back on, the system is configured with the values found in CMOS.

With easy-to-use pull down menus, you can configure such items as:

- Hard drives, diskette drives, and peripherals
- Video display type and display options
- Password protection from unauthorized use
- Power management features

The settings made in the setup program affect how the computer performs. It is important, therefore, first to try to understand all the setup options, and second, to make settings appropriate for the way you use the computer.

## When to Configure the BIOS

- This program should be executed under the following conditions:
  - When changing the system configuration
  - When a configuration error is detected by the system and you are prompted to make changes to the setup program
  - When resetting the system clock
  - When redefining the communication ports to prevent any conflicts
  - When making changes to the Power Management configuration
  - When changing the password or making other changes to the security setup

Normally, CMOS setup is needed when the system hardware is not consistent with the information contained in the CMOS RAM, whenever the CMOS RAM has lost power, or the system features need to be changed.

## Default Configuration

Most of the configuration settings are either predefined according to the Load Optimal Defaults settings which are stored in the BIOS or are automatically detected and configured without requiring any actions. There are a few settings that you may need to change depending on your system configuration.











## Entering Setup

When the system is powered on, the BIOS will enter the Power-On Self Test (POST) routines. These routines perform various diagnostic checks; if an error is encountered, the error will be reported in one of two different ways:

- If the error occurs before the display device is initialized, a series of beeps will be transmitted.
- If the error occurs after the display device is initialized, the screen will display the error message.

Powering on the computer and immediately pressing  allows you to enter Setup.

## Legends

Key	Function
	Moves the highlight left or right to select a menu.
	Moves the highlight up or down between sub-menu or fields.
	Exits the BIOS Setup Utility.
	Scrolls forward through the values or options of the highlighted field.
	Scrolls backward through the values or options of the highlighted field.
	Selects a field.
	Displays General Help.
	Load previous values.
	Load optimized default values.
	Saves and exits the Setup program.
	Press <Enter> to enter the highlighted sub-menu

## Scroll Bar

When a scroll bar appears to the right of the setup screen, it indicates that there are more available fields not shown on the screen. Use the up and down arrow keys to scroll through all the available fields.

## Submenu

When “▶” appears on the left of a particular field, it indicates that a submenu which contains additional options are available for that field. To display the submenu, move the highlight to that field and press  .

## BIOS Setup Utility

Once you enter the AMI BIOS Setup Utility, the Main Menu will appear on the screen. The main menu allows you to select from several setup functions and one exit. Use arrow keys to select among the items and press  to accept or enter the submenu.

### Main

The Main menu is the first screen that you will see when you enter the BIOS Setup Utility.



### Access Level

Displays the access level of the current user in the BIOS.

### System Date

The date format is <day>, <month>, <date>, <year>. Day displays a day, from Monday to Sunday. Month displays the month, from 1 to 12. Date displays the date, from 1 to 31. Year displays the year, from 2005 to 2099.

### System Time

The time format is <hour>, <minute>, <second>. The time is based on the 24-hour military-time clock. For example, 1 p.m. is 13:00:00. Hour displays hours from 00 to 23. Minute displays minutes from 00 to 59. Second displays seconds from 00 to 59.

## Advanced

The Advanced menu allows you to configure your system for basic operation. Some entries are defaults required by the system board, while others, if enabled, will improve the performance of your system or let you set some features according to your preference.



Setting incorrect field values may cause the system to malfunction.



## Trusted Computing

This section is used to configure Trusted Platform Module (TPM) settings.



### Security Device Support

Enables or disables BIOS support for security device. O.S will not show Security Device. TCG EFI protocol and INT1A interface will not be available.

### SHA-1 PCR Bank

Enables or disables SHA-1 PCR Bank.

### SHA256 PCR Bank

Enables or disables SHA256 PCR Bank.

### Pending operation

Schedules an operation for the security device.

### Platform Hierarchy

Enables or disables platform hierarchy.

### Storage Hierarchy

Enables or disables platform hierarchy.

### Endorsement Hierarchy

Enables or disables endorsement hierarchy.

### TPM2.0 UEFI Spec Version

Configures the TPM2.0 UEFI spec version.

### Physical Presence Spec Version

Configures the physical presence spec version.

## NCT6683D Super IO Configuration

This section is used to configure the serial port of the super IO.



### Super IO Chip

Displays the Super I/O chip used on the board.

### Serial Port 1 Configuration

Configures the IO/IRQ settings of serial port 1.

## Serial Port 1 Configuration

This section is used to configure serial port 1.



### Serial Port

Enables or disables the serial port.

### Change Settings

Selects an optimal setting for the Super IO device.

## Hardware Monitor

This section is used to monitor hardware status such as temperature, fan speed and voltages.

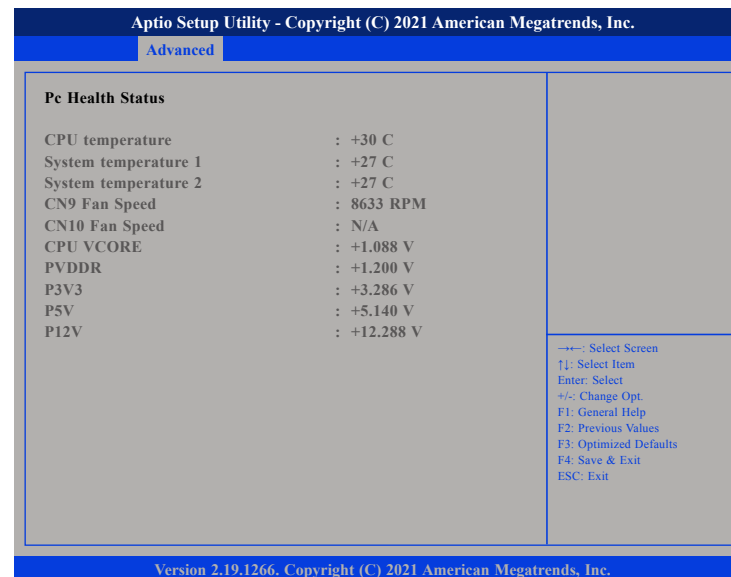

### CPU Temperature

Detects and displays the current CPU temperature.

### System Temperature 1 and System Temperature 2

Detects and displays the current temperature of the system.

### CN9 Fan Speed and CN10 Fan Speed

Detects and displays the fan speed of CN4 and CN5.

### CPU VCORE to P12V

Detects and displays the output voltages.



## Serial Port Console Redirection

This section is used to configure the serial port that will be used for console redirection.



### Console Redirection

Enables or disables the console redirection.

### Console Redirection Settings

Enables or disables the console redirection. When enabled, Console Redirection Settings will be available.

## COM0 Console Redirection Settings

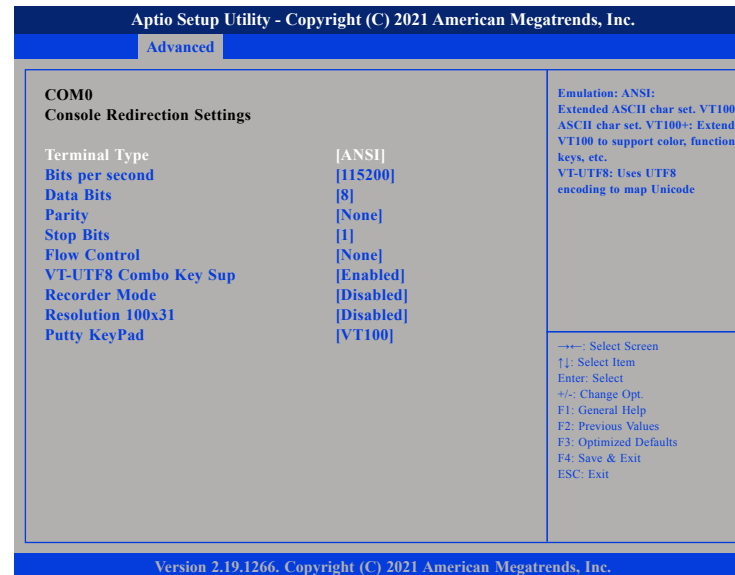

### Terminal Type

ANSI Extended ASCII character set.

VT100 ASCII character set.

VT100+ Extends VT100 to support color, function keys, etc.

VT-UTF8 Uses UTF8 encoding to map Unicode characters onto 1 or more bytes.

### Bits Per Second

Selects the serial port transmission speed. The speed must match the other side. Long or noisy lines may require a lower speed.

### Data Bits

The options are 7 and 8.

### Parity

A parity bit can be sent with the data bits to detect some transmission errors.

Even Parity bit is 0 if the number of 1's in the data bits is even.

Odd Parity bit is 0 if number of 1's in the data bits is odd.

### Stop Bits

Stop bits indicate the end of a serial data packet. (A start bit indicates the beginning). The standard setting is 1 stop bit. Communication with slow devices may require more than 1 stop bit.

### Flow Control

Flow control can prevent data loss from buffer overflow. When sending data and the receiving buffers are full, a "stop" signal can be sent to stop the data flow.

### VT-UTF8 Combo Key Support

Enables or disables VT-UTF8 combo key support.

### Recorder Mode

When this field is enabled, only text will be sent. This is to capture the terminal data.

### Resolution 100x31

Enables or disables extended terminal resolution.

### Putty Keypad

Selects the Putty keyboard emulation type.

## PCI Subsystem Settings

This section is used to configure the PCI.



### PCI Latency Timer

Configures the length of time allowed for the PCI device to control the bus before another takes over.

### VGA Palette Snoop

Enables or disables the VGA palette registers snooping.

### PERR# Generation

Enables or disables the PCI device to generate PERR#.

### SERR# Generation

Enables or disables the PCI device to generate SERR#.

### Above 4G Decoding

Enables or disables decoding of 64-bit devices in 4G address space.

### SR-IOV Support

Enables or disables SR-IOV support.

### BME DMA Mitigation

Enables or disables the function to re-enable bus master attribute during PCI enumeration for PCI bridges after SMM is locked.

## PCI Express Settings



**PCI Express Device Register Settings**

Relaxed Ordering	[Enabled]	Enables or Disables PCI Express Device Relaxed Ordering.
Extended Tag	[Disable]	
No Snoop	[Enabled]	
Maximum Payload	[1024 Bytes]	
Maximum Read Request	[256 Bytes]	

**PCI Express Link Register Settings**

ASPM Support	[Disable]	---: Select Screen ↑↓: Select Item Enter: Select +/-: Change Opt. F1: General Help F2: Previous Values F3: Optimized Defaults F4: Save & Exit ESC: Exit
Extended Synch	[Disable]	

Link Training Retry [5]  
 Link Training Timeout [1000]  
 Unpopulated Links [Keep Link ON]

Version 2.19.1266. Copyright (C) 2021 American Megatrends, Inc.

### Relaxed Ordering

Enables or disables the PCI Express device's relaxed ordering.

### Extended Tag

When this function is enabled, it allows a device to use 8-bit tag field as a request.

### No Snoop

Enables or disables the PCI Express device's no snoop option.

### Maximum Payload

Selects the maximum TLP payload size of the PCI Express devices.

### Maximum Read Request

Selects the maximum read request size of the PCI Express devices.

### ASPM Support

Selects the ASPM level.

Force L0 Forces all links to L0 state.

Auto The BIOS automatically selects an ASPM level.

Disable Disables ASPM.

### Extended Synch

When this function is enabled, it allows generation of extended synchronization patterns.

### Link Training Retry

Selects the number of retry attempts.

### Link Training Timeout

Selects the timeout period of link training in microseconds.

### Unpopulated Links

Enables or disables unpopulated PCI Express links.

## PCI Express GEN 2 Settings

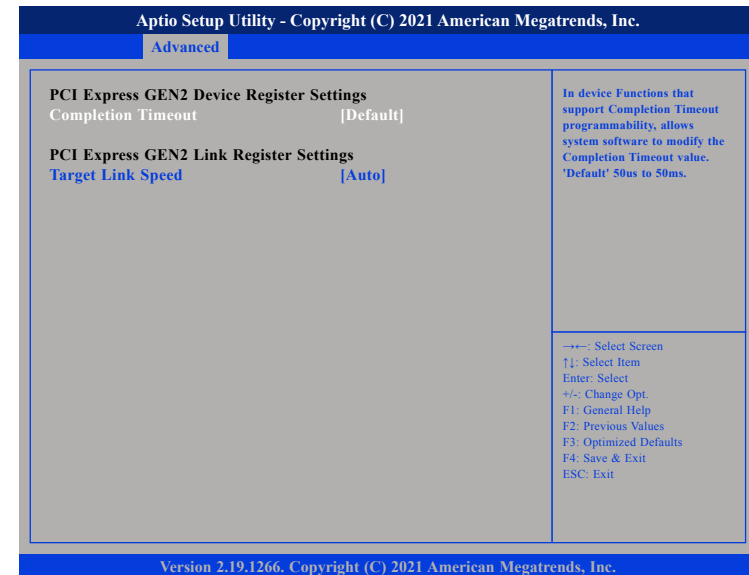

### Completion Timeout

Configures the completion timeout value.

### Target Link Speed

Configures the PCIe link speed.

## Network Stack Configuration

This section is used to configure the network stack.

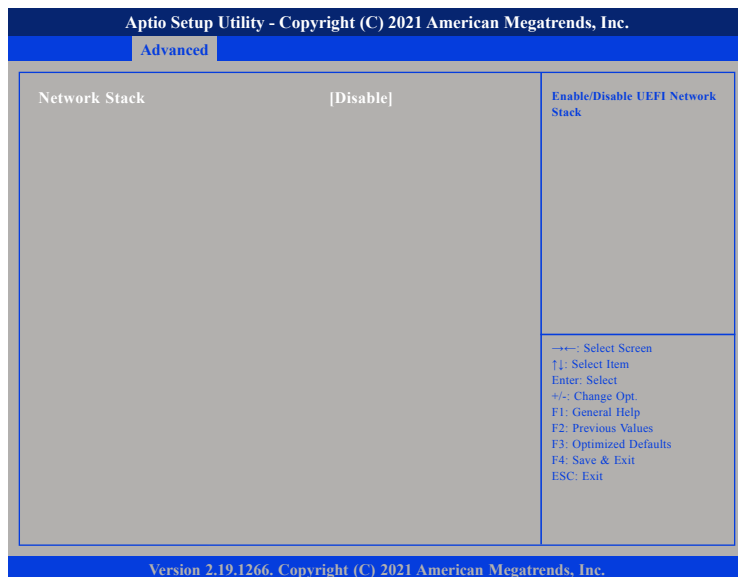

### Network Stack

Enables or disables UEFI network stack.

## CSM Configuration

This section is used to configure the compatibility support module features.

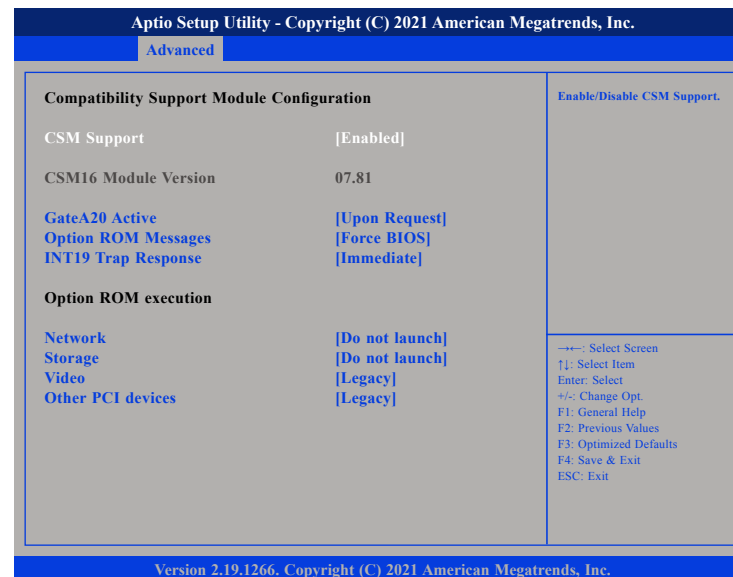

### CSM Support

This field is used to enable or disable CSM support, if Auto option is selected, based on OS, CSM will be enabled or disabled automatically.

### GateA20 Active

Upon Request GA20 can be disabled using BIOS services.  
 Always Do not allow disabling of GA20; this option is useful when any RT code is executed above 1MB.

### Option ROM Messages

This field is used to set display mode for Option ROM. The options are Force BIOS and Keep Current.

### INT19 Trap Response

Allows Option ROMs to trap Interrupt 19 when enabled.

Immediate	Execute the trap right away.
Postponed	Execute the trap during legacy boot.

### Network

Enables or disables the boot option for legacy network devices.

### Storage

Enables or disables the boot option for legacy storage devices.

### Video

Enables or disables the boot option for legacy video devices.

### Other PCI Devices

Enables or disables the boot option for legacy PCI devices.

### SDIO Configuration

This section is used to configure the SDIO access mode.

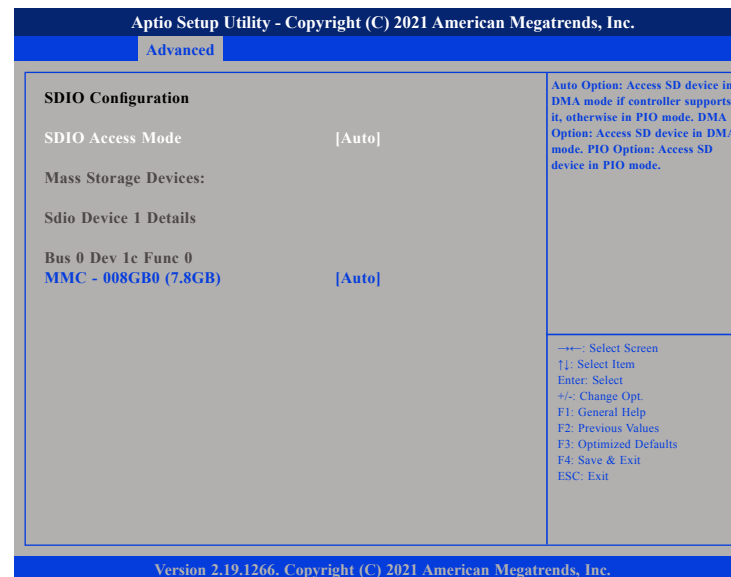

### SDIO Configuration

Auto Option: Access SD device in DMA mode if controller support it, otherwise in PIO mode.

DAM Option: Access SD device in DMA mode.

PIO Option: Access SD device in PIO mode

## USB Configuration

This section is used to configure the USB.



### Legacy USB Support

Enable Enables Legacy USB.

Auto Disables support for Legacy when no USB devices are connected.

Disable Keeps USB devices available only for EFI applications.

### XHCI Hand-off

This is a workaround for OSs that does not support XHCI hand-off. The XHCI ownership change should be claimed by the XHCI driver.

### USB Mass Storage Driver Support

Enables or disables USB mass storage driver support.

### Port 60/64 Emulation

Enables the 60h/64h I/O port emulation. You must enable this to fully support USB keyboard legacy for non-USB OSes.

### Mass Storage Devices

Configures the mass storage device emulation type. AUTO enumerates devices according to their media format. Optical drives are emulated as CDROM, drives with no media will be emulated according to a drive type.

## Intel RC Setup

This section is used to configure the processor and chipset settings.



### Relax Security Config

Enables or disables the security configuration to be able to use BIOS update tools.

## Processor Configuration

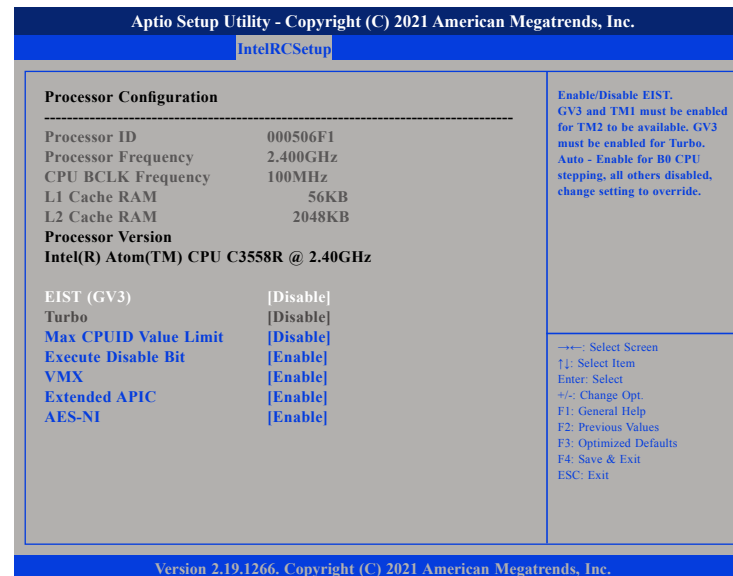

### EIST (GV3)

Enables or disables Intel® SpeedStep. GV3 and TM1 must be enabled for TM2 to be available. GV3 must be enabled for Turbo.

Auto - Enable for B0 CPU stepping, all others will be disabled, change setting to override.

### Max CPUID Value Limit

Set this field to Disable when using Windows XP. Set this field to Enable when using legacy operating systems so that the system will boot even when it doesn't support CPUs with extended CPUID function.



### Execute Disable Bit

When this field is set to Disable, it will force the XD feature flag to always return to 0.

### VMX

When this field is set to Enabled, the VMM can utilize the additional hardware capabilities provided by Vanderpool Technology.

### Extended APIC

Enables or disables extended APIC support.

### AES-NI

Enables or disables Intel® AES-NI support.

## North Bridge Chipset Configuration

The screenshot shows the BIOS setup utility interface. At the top, it reads 'Aptio Setup Utility - Copyright (C) 2021 American Megatrends, Inc.' and 'IntelRCSetup'. The main section is titled 'North Bridge Chipset Configuration'. Below this, there is a 'Memory Information' section with the following details:

Total Memory	4096 MB
Memory Frequency	DDR4 - 2400 MHz
Memory Frequency	[DDR-2400]

Below the memory information, there is a blue arrow pointing to 'SSA Config'. To the right of the main configuration area, there is a box containing the following text:

DDR memory frequency:  
DDR4 up to DDR-2666  
DDR3 up to DDR-1867

At the bottom right of the screen, there is a legend for navigation keys:

- ←: Select Screen
- ↑↓: Select Item
- Enter: Select
- +/-: Change Opt.
- F1: General Help
- F2: Previous Values
- F3: Optimized Defaults
- F4: Save & Exit
- ESC: Exit

At the very bottom of the screen, it reads 'Version 2.19.1266. Copyright (C) 2021 American Megatrends, Inc.'

### Memory Frequency

Configures the DDR memory frequency.

## SSA Config

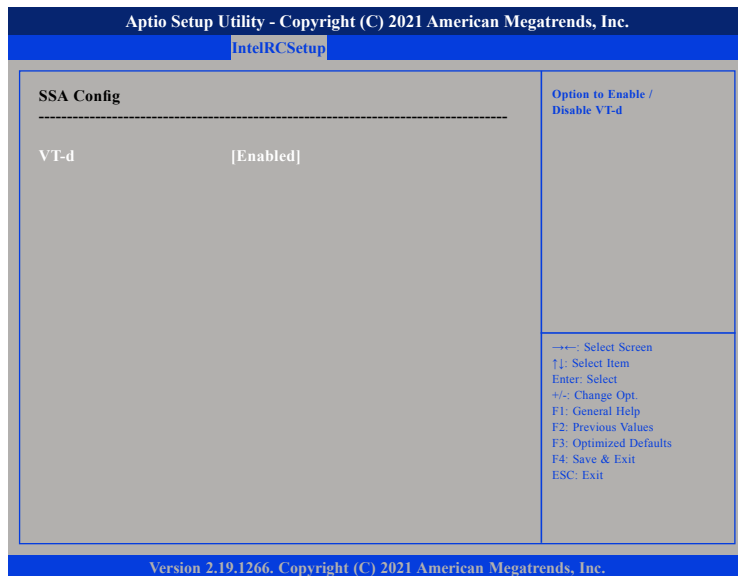

### VT-d

Enables or disables Intel® VT-d technology.

## South Bridge Chipset Configuration



### State After G3

Configures which state to use when power is re-applied after a power failure (G3 state).

## South Bridge USB Configuration



### USB SS Configuration

Enters the sub-menu for USB super speed configuration.

### USB HS Configuration

Enters the sub-menu for USB high speed configuration.

## USB SS Configuration

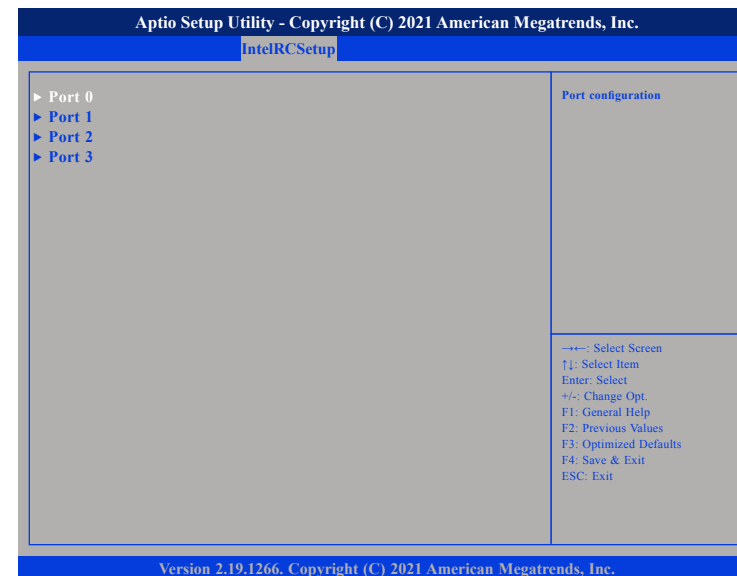

### Port 0 to Port 3

Enters the sub-menu for port 0, port 1, port 2 and port 3 configuration.

### USB SS Port 0



#### USB SS Physical Connector

Enables or disables the USB Physical Connector (physical port). Once disabled, any USB devices plugged into the connector will not be detected by BIOS or OS.

### USB SS Port 1

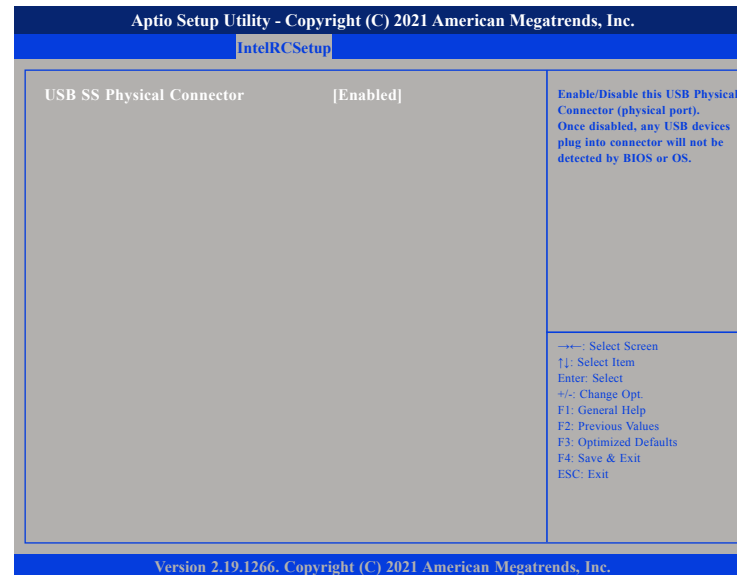

#### USB SS Physical Connector

Enables or disables the USB Physical Connector (physical port). Once disabled, any USB devices plugged into the connector will not be detected by BIOS or OS.

## USB SS Port 2

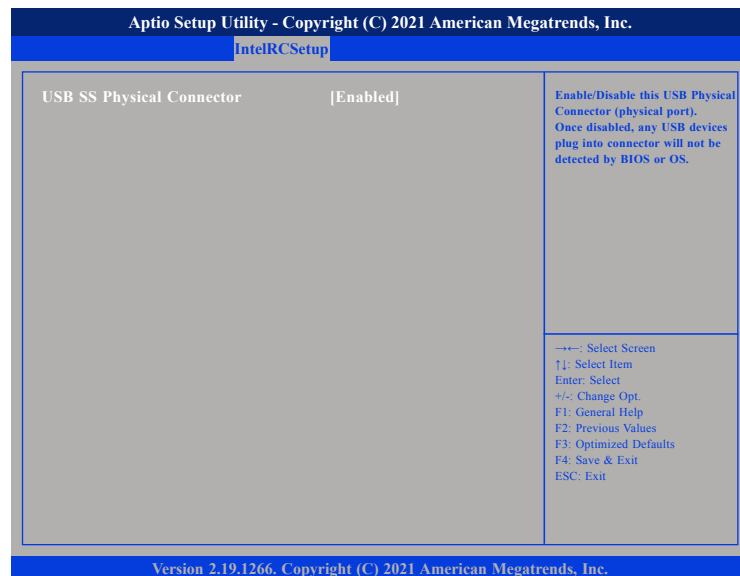

### USB SS Physical Connector

Enables or disables the USB Physical Connector (physical port). Once disabled, any USB devices plugged into the connector will not be detected by BIOS or OS.

## USB SS Port 3

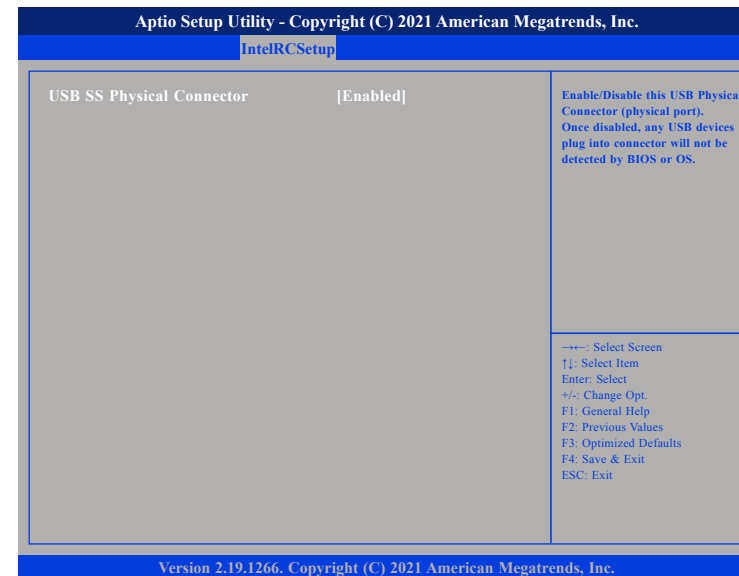

### USB SS Physical Connector

Enables or disables the USB Physical Connector (physical port). Once disabled, any USB devices plugged into the connector will not be detected by BIOS or OS.

## USB HS Configuration



### Port 0 to Port 3

Enters the sub-menu for port 0 to port 3 configuration.

## USB HS Port 0

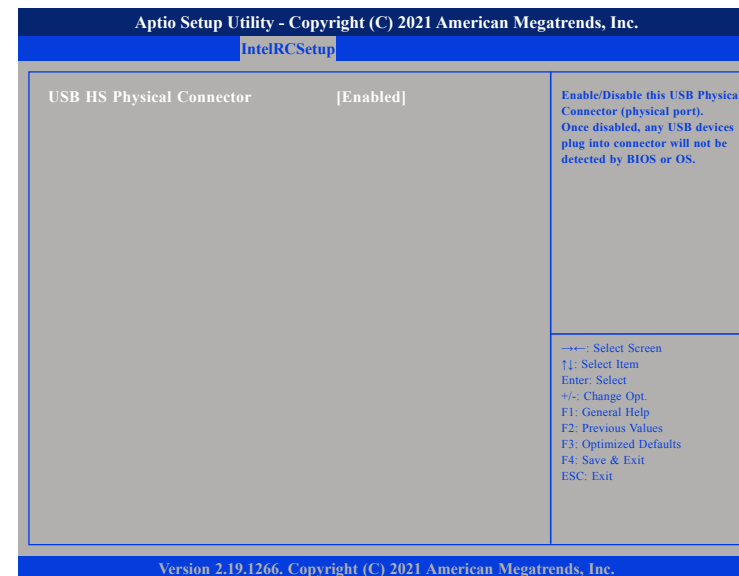

### USB HS Physical Connector

Enables or disables the USB Physical Connector (physical port). Once disabled, any USB devices plugged into the connector will not be detected by BIOS or OS.

## USB HS Port 1

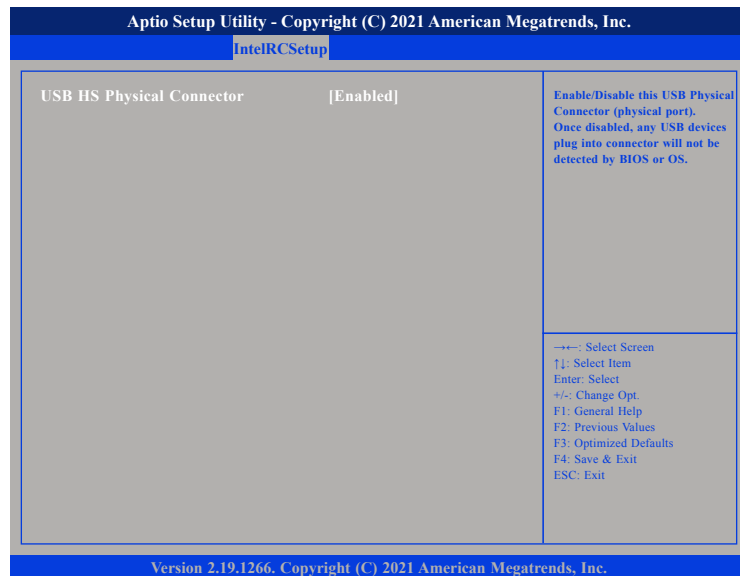

### USB HS Physical Connector

Enables or disables the USB Physical Connector (physical port). Once disabled, any USB devices plugged into the connector will not be detected by BIOS or OS.

## USB HS Port 2

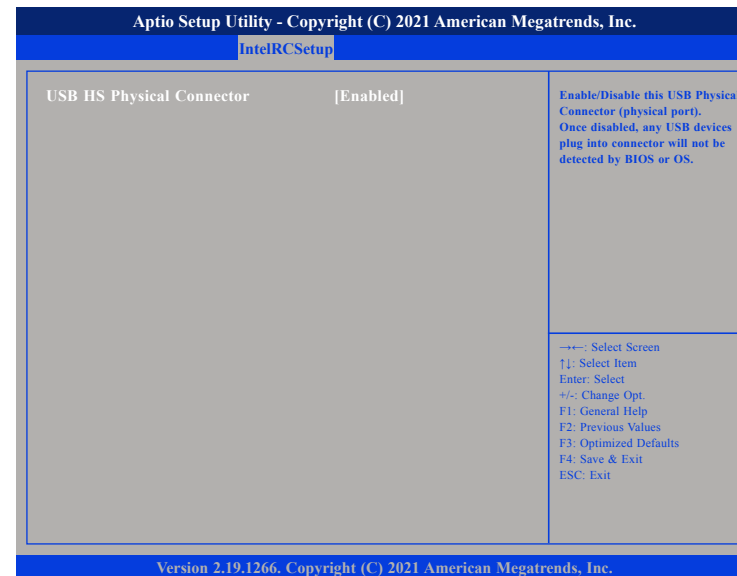

### USB HS Physical Connector

Enables or disables the USB Physical Connector (physical port). Once disabled, any USB devices plugged into the connector will not be detected by BIOS or OS.

### USB HS Port 3



#### USB HS Physical Connector

Enables or disables the USB Physical Connector (physical port). Once disabled, any USB devices plugged into the connector will not be detected by BIOS or OS.

### IQAT Configuration



#### IQAT

Enables or disables hiding of IQAT device from an OS.

#### Set IQAT FUSECTL

Enables or disables the configuration of IQAT FUSECTL register.

#### Set 64B MRR/MPL

Enables or disables the configuration of 64B MRR/MPL in IQAT DevCTL register.



## Security

Aptio Setup Utility - Copyright (C) 2021 American Megatrends, Inc.					
Main	Advanced	IntelRCSetup	Security	Boot	Save & Exit
<p><b>Password Description</b></p> <p>If <b>ONLY</b> the Administrator's password is set, then this only limits access to Setup and is only asked for when entering Setup. The password length must be in the following range:</p> <p>Minimum length            3 Maximum length            20</p> <p>Administrator Password</p>		<p>Set Administrator Password</p>			
		<p>←→: Select Screen ↑↓: Select Item Enter: Select +/-: Change Opt. F1: General Help F2: Previous Values F3: Optimized Defaults F4: Save &amp; Exit ESC: Exit</p>			
Version 2.19.1266. Copyright (C) 2021 American Megatrends, Inc.					

### Administrator Password

Select this to reconfigure the administrator's password.

## Boot

Aptio Setup Utility - Copyright (C) 2021 American Megatrends, Inc.					
Main	Advanced	IntelRCSetup	Security	Boot	Save & Exit
<p><b>Boot Configuration</b></p> <p>Setup Prompt Timeout            3 Bootup NumLock State            [On] Quiet Boot                            [Disabled]</p> <p>Boot mode select                    [LEGACY]</p> <p><b>FIXED BOOT ORDER Priorities</b></p> <p>Boot Option #1                    [Hard Disk:MMC - 008GB0] Boot Option #2                    [CD/DVD] Boot Option #3                    [USB Hard Disk] Boot Option #4                    [USB CD/DVD] Boot Option #5                    [USB Key:KingstonDat...] Boot Option #6                    [USB Floppy] Boot Option #7                    [USB Lan] Boot Option #8                    [Network]</p> <p>▶ Hard Disk Drive BBS Priorities</p>		<p>Number of seconds to wait for setup activation key. 65535 (0xFFFF) means indefinite waiting.</p>			
		<p>←→: Select Screen ↑↓: Select Item Enter: Select +/-: Change Opt. F1: General Help F2: Previous Values F3: Optimized Defaults F4: Save &amp; Exit ESC: Exit</p>			
Version 2.19.1266. Copyright (C) 2021 American Megatrends, Inc.					

### Setup Prompt Timeout

Selects the number of seconds to wait for the setup activation key. 65535(0xFFFF) denotes indefinite waiting.

### Bootup NumLock State

This allows you to determine the default state of the numeric keypad. By default, the system boots up with NumLock on wherein the function of the numeric keypad is the number keys. When set to Off, the function of the numeric keypad is the arrow keys.

### Quiet Boot

Enabled Displays OEM logo instead of the POST messages.  
 Disabled Displays normal POST messages.

### Boot Mode Select

Configures the boot mode option.

### Boot Option #1 to Boot Option #8

Adjust the boot sequence of the system. Boot Option #1 is the first boot device that the system will boot from, next will be Boot Option #2 and so forth.

## Save & Exit



### Save Changes and Reset

To save the changes and reset, select this field then press <Enter>. A dialog box will appear. Confirm by selecting Yes.

### Discard Changes and Reset

To exit the Setup utility and reset without saving the changes, select this field then press <Enter>. You may be prompted to confirm again before exiting.

### Restore Defaults

To restore the BIOS to default settings, select this field then press <Enter>. A dialog box will appear. Confirm by selecting Yes.



### **Boot Override**

To bypass the boot sequence from the Boot Option List and boot from a particular device, select the desired device and press <Enter>.

### **Launch EFI Shell from filesystem device**

To launch EFI shell from a filesystem device, select this field and press <Enter>.