

QBiX-JMB-ADLA67EH-A1

Industrial Fanless System with Intel® Q670E Chipset,
Support for Intel® 13th/12th Gen. Core™ i Processor

Startup Manual

Packing List

Before you begin installing your card, please make sure that the following items have been shipped:

1. Screw HDD x 20 pcs (25984G-1C014-S00)
2. 4-pin Terminal Blocks Male Plug x 1 pcs (25IO0-2ESDV0-D2R)

Caution: DANGER OF EXPLOSION IF BATTERY IS INCORRECTLY REPLACED. REPLACE ONLY WITH THE SAME OR EQUIVALENT TYPE RECOMMENDED BY THE MANUFACTURER, DISCARD USED BATTERIES ACCORDING TO THE MANUFACTURER'S INSTRUCTIONS.

Dimension

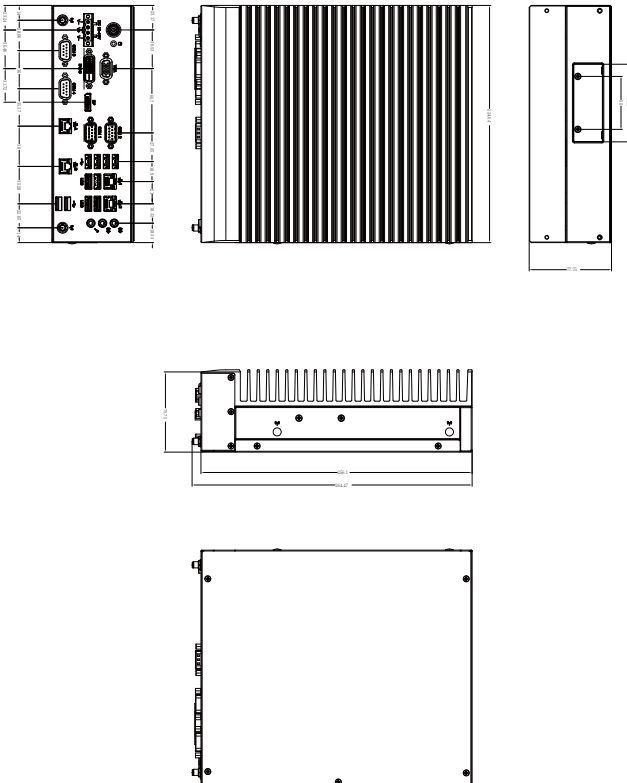

Specifications

Dimension	System Size: 224W x 256.1D x 77.7H(mm)
CPU	Support for 13th/12th Generation Intel® Core™ i9/i7/i5/i3, Pentium® and Celeron® processors in the LGA1700 package, TDP under 65W
Chipset	Intel® Q670E Express Chipset
Memory	2 x DDR4 SO-DIMM sockets supporting up to 64 GB, Dual channel DDR4 3200 MHz
Ethernet	1 x 2.5GbE LAN Port (Intel® I226V) 1 x GbE LAN Port (Intel® I219LM, Vpro support) 2 x GbE LAN Ports (Intel® I211AT)
Graphic support	Integrated Graphics Processor - depends on CPU: 1 x DVI-D port, supporting a maximum resolution of 1920x1080 @60Hz 1 x D-Sub port, supporting a maximum resolution of 1920x1200 @60Hz 1 x DP port, supporting a maximum resolution of 4096x2160 @60Hz 3 independent displays output
Audio	Realtek® ALC897
Storage	4 x 2.5" HDD/SSD (SATA 6Gb/s)
Raid	RAID 0/1/5/10
Expansion Slots	1 x 2280 M.2 M-Key (PCIe Gen4x4) 1 x 2230 M.2 E-Key (WiFi/BT) 1 x Full-size Mini PCIe with SIM slot

Front I/O	1 x Power Switch/Power/HDD LED 1 x DC IN (4-pin Terminal Block +12V~48V) 1 x VGA / 1 x DVI-D /1 x DP 2 x COM Ports (RS-232/422/485 & RI/5V/12V) 2 x COM Ports (RS-232) 4 x RJ45 LAN Ports 2 x USB 3.2 Gen 2x1 2 x USB 3.2 Gen 1 6 x USB 2.0 3 x Audio Jacks (Line in, Line out & Mic in) 2 x External Antenna Holes (Optional)
Rear I/O	—
Power	DC in +12V~48VDC (Full Range)
Operation Temperature	Operating temperature: -20°C to 50°C (CPU 65W TDP) Operating temperature: -20°C to 60°C (CPU 35W TDP) Operating humidity: 0-90% (non-condensing) Non-operating temperature: -40°C to 85°C Non-operating humidity: 0%-95% (non-condensing) Use wide temperature range memory and storage
Vibration During Operation	Operation: IEC 60068-2-64, 3 Grms, random, 5 ~ 500 Hz, 1 hr / Per Axis, with SSD/M.2 2280 Non-operation: IEC 60068-2-6, 2 G, Sine, 10 ~ 500 Hz, 1 Oct/min, 1 hr / Per Axis
Shock During Operation	Operation: IEC 60068-2-27, 50 G, half sine, 11 ms duration, With SSD
Packaging Content	Carton size: 300 x 351 x 166 (mm) Packing Capacity : 1 Including: Terminal Blocks Male Plug x 1pc (25IO0-2ESDV0-D2R) Screw M3x4L x 20pcs (25984G-1C014-S00)
Order Information	System : 6BQJQ67EAMR-SI (Box packing)

System I/O Interface

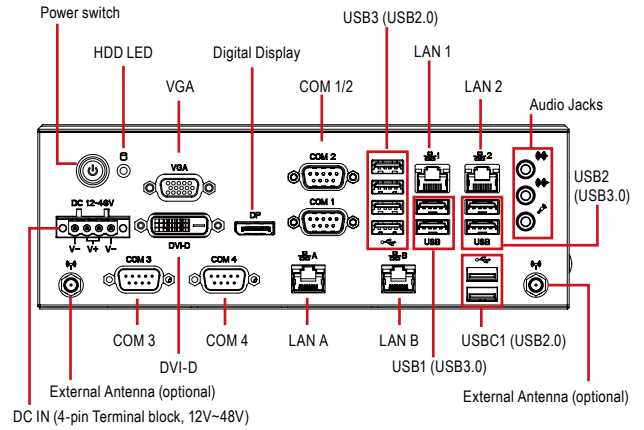

Jumpers and Connectors

The board has a number of jumpers that allow you to configure your system to suit your application. The table below lists the function of each of the jumpers and connectors.

Front I/O Connectors

No.	Code	Scripton
1	VGA	VGA Connector
2	DVI-D	DVI-D Connector
3	DP	Digital Display Port
4	COM 1/2	RS-232/422/485
5	COM 3/4	RS-232
6	USB 1	2 x USB 3.2 Gen 1
7	USB 2	2 x USB 3.2 Gen 2x1
8	USB 3	4 x USB 2.0
9	USB C1	2 x USB 2.0
10	LAN 1	Intel® I219LM
11	LAN 2	Intel® I226V
12	LAN A	Intel® I211AT
13	LAN B	Intel® I211AT
14	LED	Power and Storage Device Status LED
15	DC-12-48V	Power connector
16	Audio	Audio Jacks (Line in, Line out & Mic in)

Internal I/O Connectors

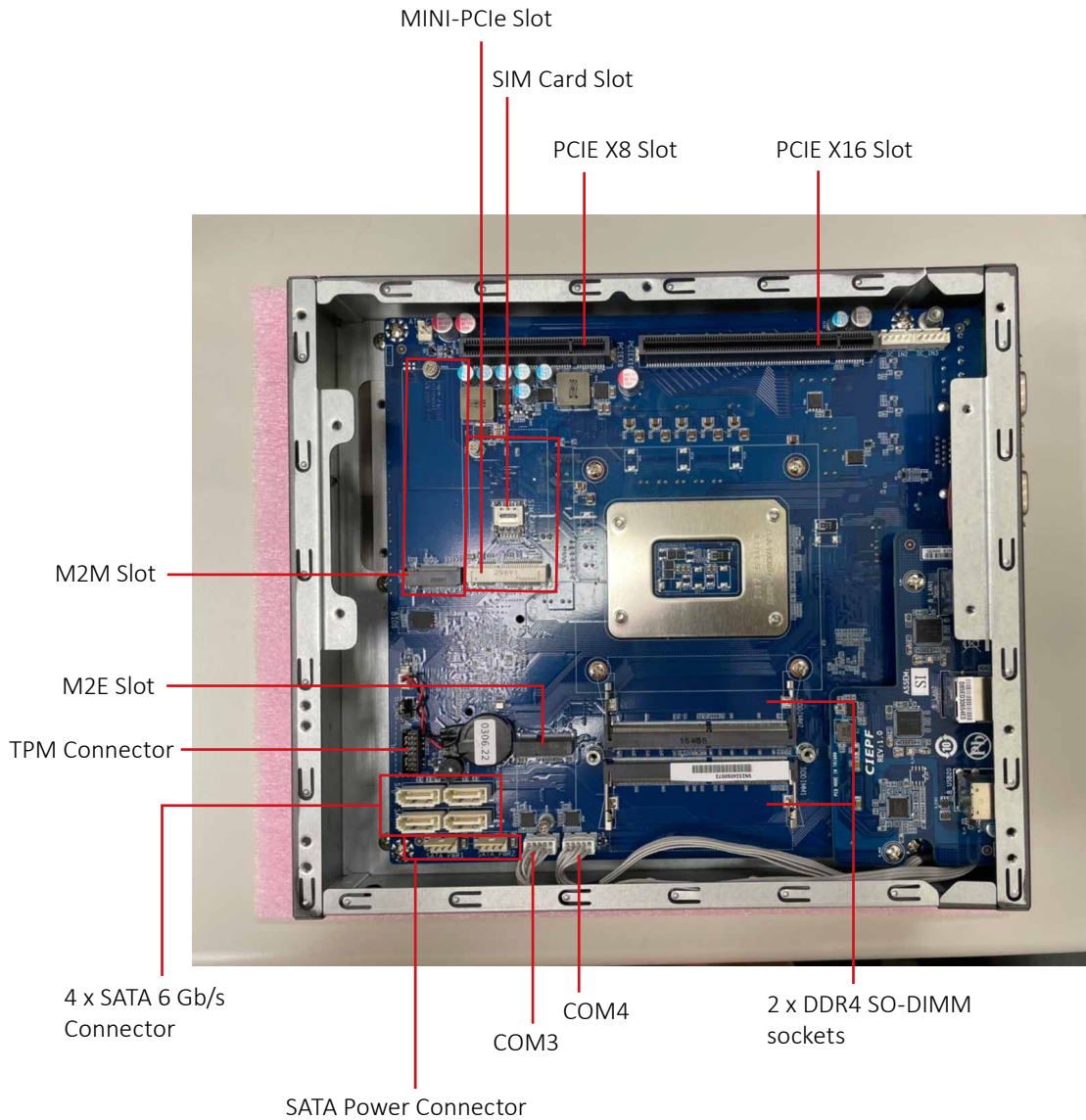

Simple Installation Process

Memory Installation

QBiX-JMB-ADLA67EH-A1 supports DDR4 SO-DIMM type memory module.

1. Loosen 7 screws and remove the bottom cover.
2. Loosen 4 screws to remove memory thermal cover.
3. Remove the release paper, and assemble memory.
4. Install 4 screws and memory thermal cover.

Note : Thermal pad and memory thermal cover must be fully mated and compacted.

5. Replace the bottom cover and secure with screws.

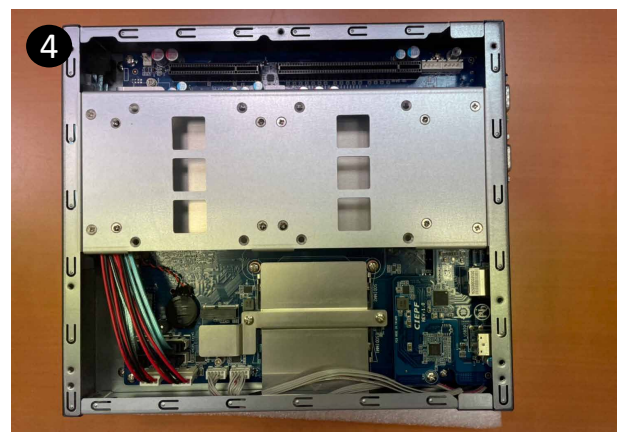
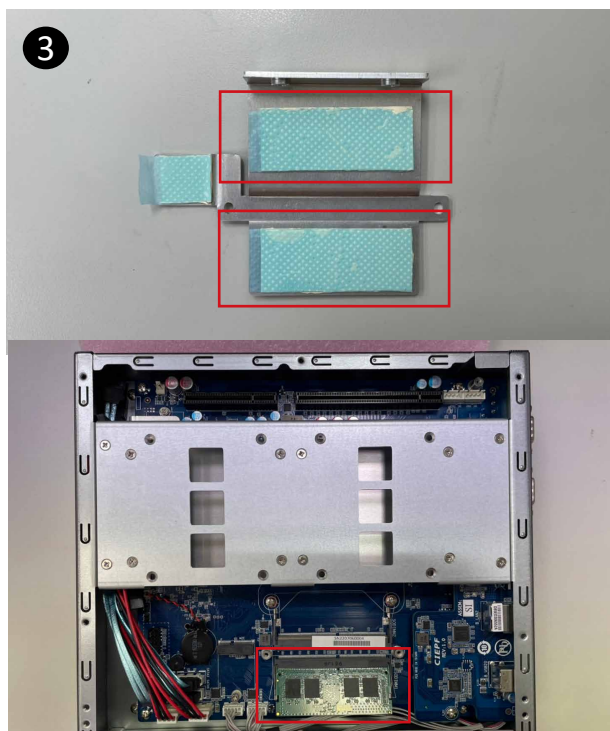

M2E (Support NGFF-2230 Wifi/BT) Installation

1. Loosen 7 screws and remove the bottom cover.
2. Loosen 4 screws to remove M2E thermal cover.
3. Install the module in the M2E (Support NGFF-2230 Wifi/BT) slot and secure with screws.
4. Remove the release paper on the thermal pad.
5. Install 4 screws and M2E thermal cover.
6. Replace the bottom cover and secure with screws.

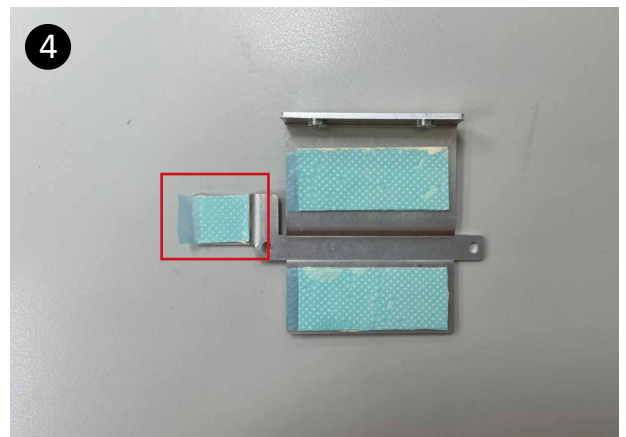
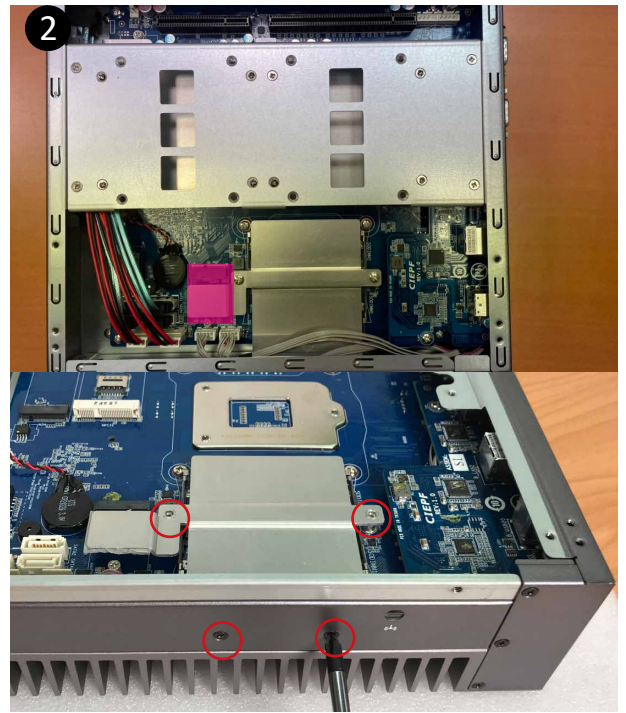

Storage Installation 1 (2.5" HDD/SSD)

1. Loosen 7 screws and remove the bottom cover
2. Loosen 4 screws to remove storage tray.
3. Secure storage with 4 x screws.
4. Assemble SATA cable/power cable and replace storage tray securely with 4 x screws.
5. Replace the bottom cover and secure with screws.

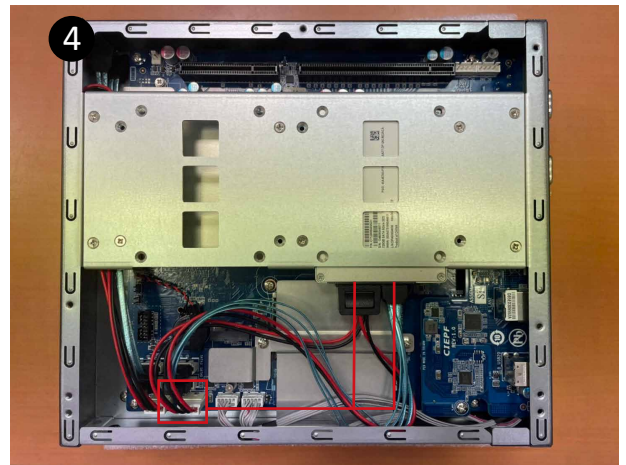
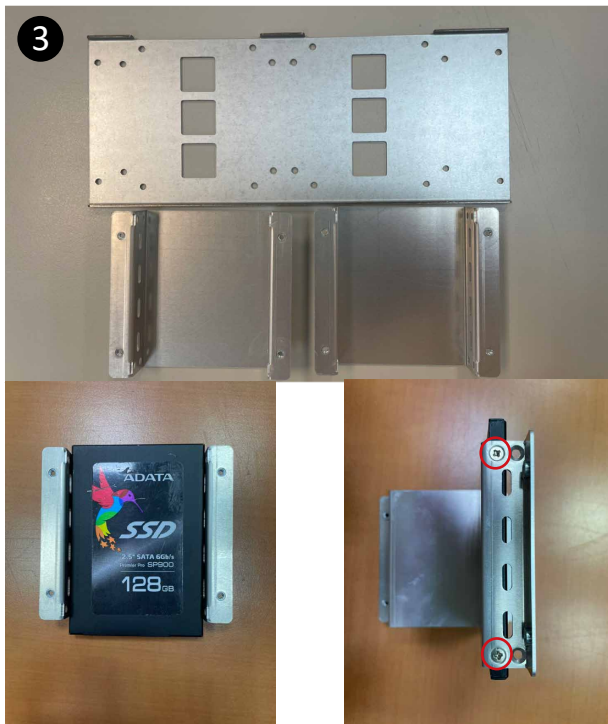
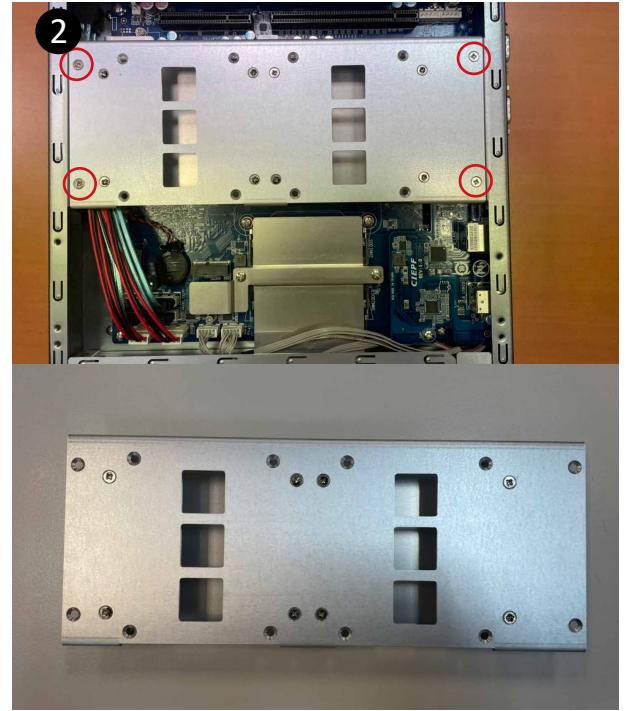

Storage Installation 2 (M2M Storage)

1. Loosen 7 screws, and then remove the bottom cover
2. Loosen 4 screws to remove the hard disk storage aluminum sheet
3. Loosen the 2 screws to remove the aluminum heat sink.
4. Assemble the M2M (NGFF-2280 SATA) storage hard drive, and remove the release paper which is on the aluminum heat sink.
5. Install the 2 screws to securely replace the aluminum heat sink and heat sink paste.
6. Install 4 screws to firmly install the hard disk storage aluminum sheet
7. Replace the bottom cover and secure with screws.

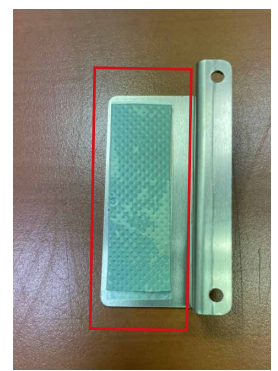
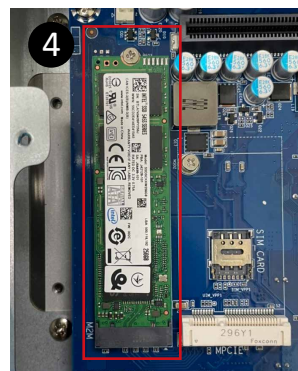
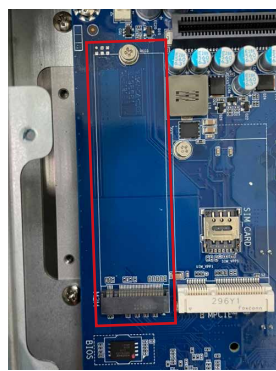
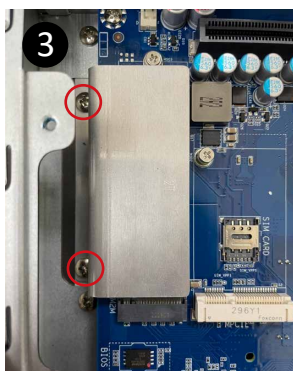
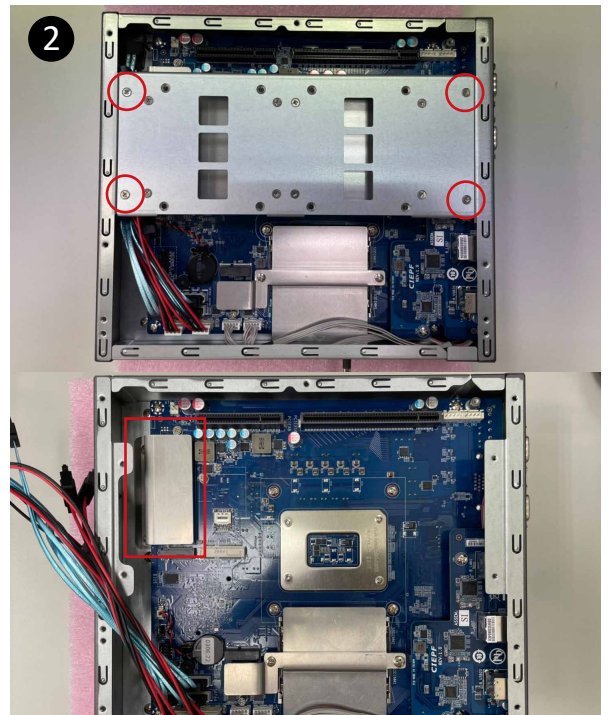

Mini-PCle Slot (PClex1 + USB2.0) and SIM Card Slot Installation

QBiX-JMB-ADLA67EH-A1 supports one full size Mini-PCle.

1. Loosen 7 screws, and then remove the bottom cover
2. Loosen 4 screws to remove the hard disk storage aluminum sheet
3. Assemble the Mini-PCle expansion Card (Mini-PClex1 + USB2.0) or 3G/4G SIM Card in SIM Slot.
4. Install 4 screws to firmly install the hard disk storage aluminum sheet
5. Replace the bottom cover and secure with screws.

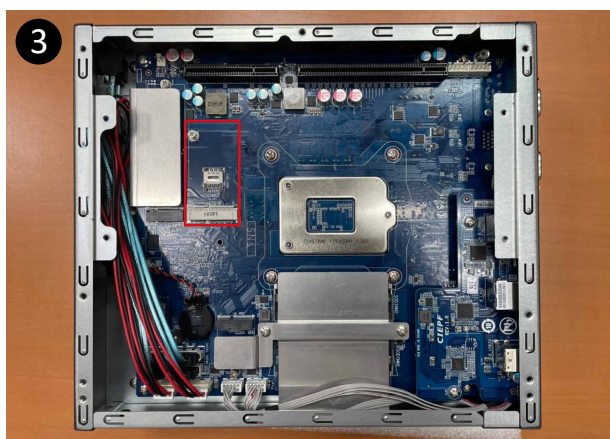
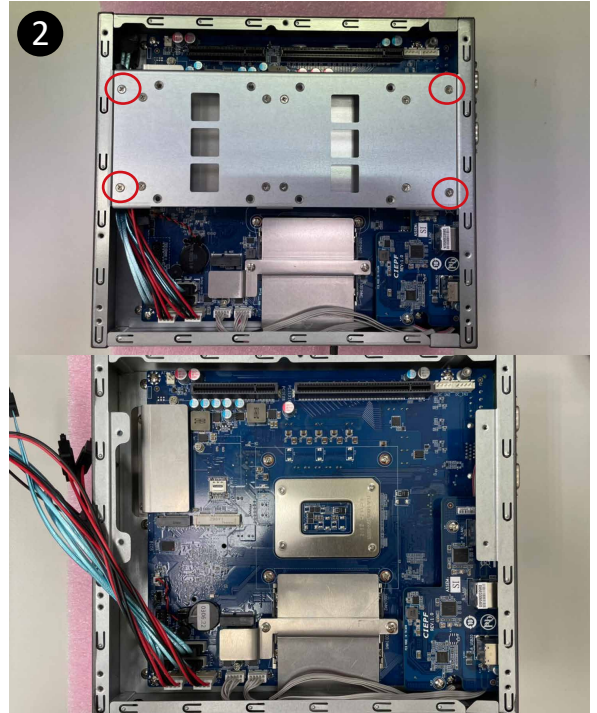

Safety Instructions

1. Read these safety instructions carefully.
2. Keep this Startup Manual for later reference.
3. Disconnect this equipment from any AC outlet before cleaning. Use a damp cloth. Do not use liquid or spray detergents for cleaning.
4. For plug-in equipment, the power outlet socket must be located near the equipment and must be easily accessible.
5. Keep this equipment away from humidity.
6. Put this equipment on a reliable surface during installation. Dropping it or letting it fall may cause damage.
7. The openings on the enclosure are for air convection. Protect the equipment from overheating. **DO NOT COVER THE OPENINGS.**
8. Make sure the voltage of the power source is correct before connecting the equipment to the power outlet.
9. Position the power cord so that people cannot step on it. Do not place anything over the power cord.
10. All cautions and warnings on the equipment should be noted.
11. If the equipment is not used for a long time, disconnect it from the power source to avoid damage by transient overvoltage.
12. Never pour any liquid into an opening. This may cause fire or electrical shock.
13. Never open the equipment. For safety reasons, the equipment should be opened only by qualified service personnel.
14. If one of the following situations arises, get the equipment checked by service personnel:
 - The power cord or plug is damaged.
 - Liquid has penetrated into the equipment.
 - The equipment has been exposed to moisture.
 - The equipment does not work well, or you cannot get it to work according to the user's manual.
 - The equipment has been dropped and damaged.
 - The equipment has obvious signs of breakage.
15. **DO NOT LEAVE THIS EQUIPMENT IN AN ENVIRONMENT WHERE THE STORAGE TEMPERATURE MAY GO BELOW -40°C (-40°F) OR ABOVE 85°C (185°F). THIS COULD DAMAGE THE EQUIPMENT. THE EQUIPMENT SHOULD BE IN A CONTROLLED ENVIRONMENT.**
16. **CAUTION: DANGER OF EXPLOSION IF BATTERY IS INCORRECTLY REPLACED. REPLACE ONLY WITH THE SAME OR EQUIVALENT TYPE RECOMMENDED BY THE MANUFACTURER, DISCARD USED BATTERIES ACCORDING TO THE MANUFACTURER'S INSTRUCTIONS.**
17. **RESTRICTED ACCESS AREA:** The equipment should only be installed in a Restricted Access Area.
18. **DISCLAIMER:** This set of instructions is given according to IEC 704-1. GIGAIPC disclaims all responsibility for the accuracy of any statements contained here in.



QBiX-JMB-ADLA67EH-A1

Industrial Fanless System with Intel® Q670E Chipset,
Support for Intel® 13th/12th Gen. Core™ i Processor

BIOS Manual

Introduction

BIOS (Basic input/output system) provides hardware detailed information and boot-up options, which include firmware to control, set-up and test all hardware settings. Therefore, BIOS is the communication bridge between OS/application software and hardware.

How to Entering into BIOS menu

Once the system is power on, press the key as soon as possible to access into BIOS Setup program.

Function Keys to setup in BIOS Setup program

Function keys	Description
→←	Select Screen
↑↓	Select Item
Enter	Execute command or enter the submenu
+	Increase the numeric value or make changes
—	Decrease the numeric value or make changes
F1	General Help
F2	Previous Values
F3	Load Optimized Defaults Settings
F4	Save changes & Exit the BIOS Setup program
ESC	Exit the BIOS Setup program

1. The Main Menu

The main menu shows the basic system information. Use arrow keys to move among the items.

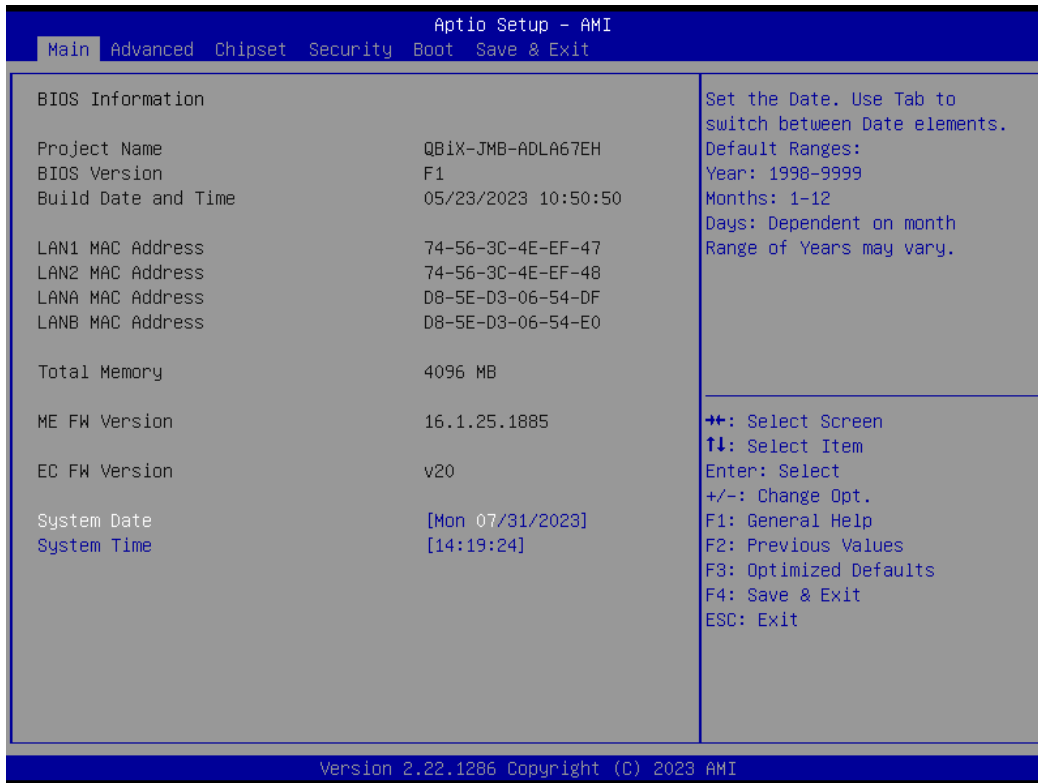

Items	Description
Project Name	Shows Project name information
BIOS Version	Shows the BIOS version of the system
Build Date and Time	Shows the Build Date and Time when the BIOS was created.
LAN1 MAC Address	Shows LAN1 MAC Address information
LAN2 MAC Address	Shows LAN2 MAC Address information
LANA MAC Address	Shows LANA MAC Address information
LANB MAC Address	Shows LANB MAC Address information
Total Memory	Shows the total memory size of the installed memory
ME FW version	Shows ME firmware version
EC FW version	Shows EC firmware version
System Date	Set the Date for the system (Format : Week - Month - Day - Year)
System Time	Set the time for the system (Format : Hour - Minute - Second)

2. Advanced

The Advanced menu is to configure the functions of hardware settings through submenu. Use arrow keys to move among the items, and press <Enter> to access into the related submenu.

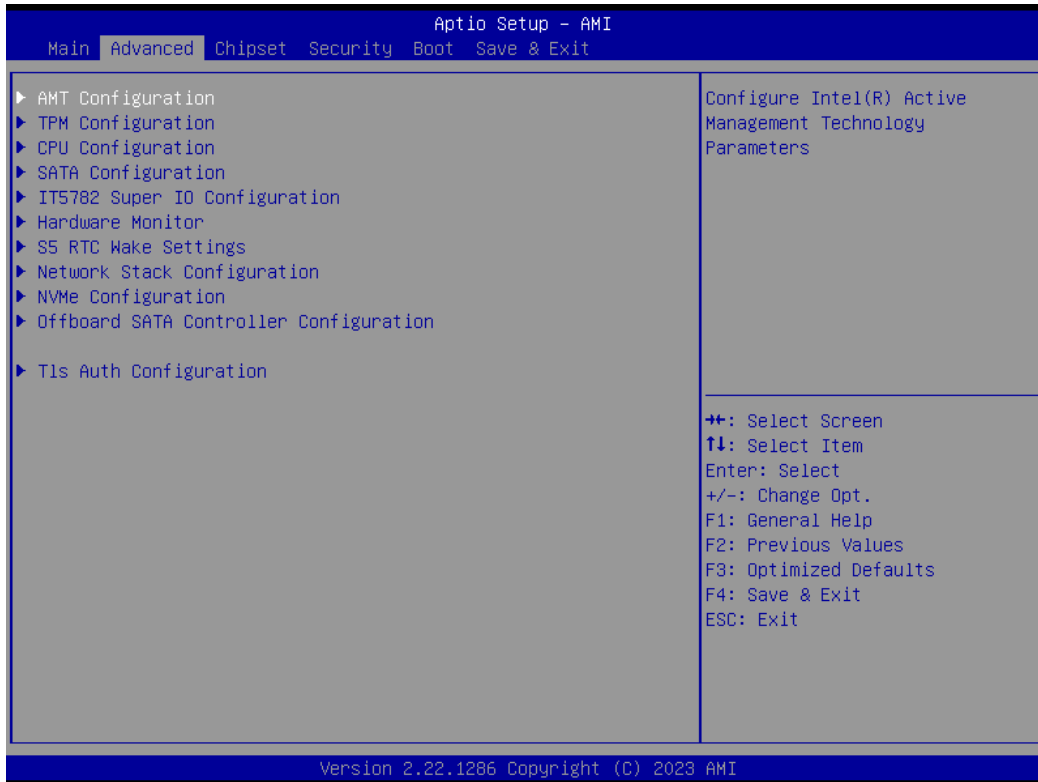

2.1 AMT configuration

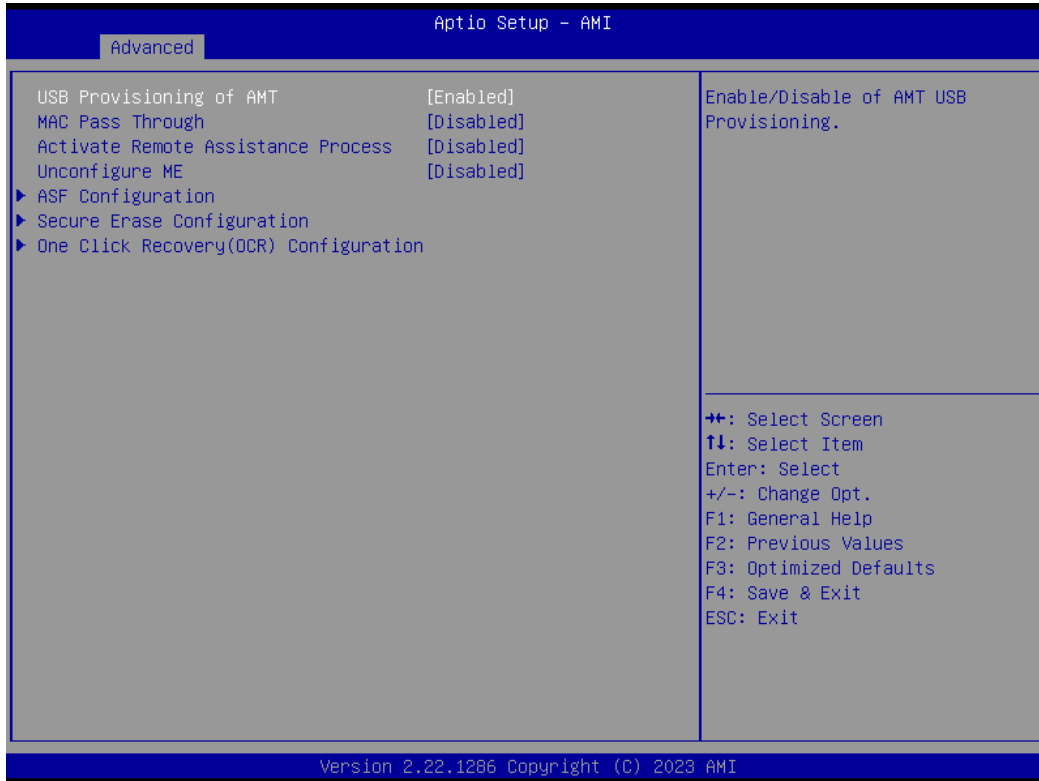

Item	Description
USB Provisioning of AMT	Inserting a specially formatted USB drive into a system, to let the other system remotely control. Disabled : Disables USB Provisioning of AMT Enabled : Enables USB Provisioning of AMT (Default setting)
MAC Pass Through	Disabled : Disables MAC Pass Through function (Default setting) Enabled : Enables MAC Pass Through function
Activate Remote Assistance Process	Trigger CIRA boot Disabled : Disables TPM feature (Default setting) Enabled : Enables TPM feature
Unconfigure ME	To Un-configure ME without password. Disabled : Disables Unconfigure ME (Default settings) Enabled : Enables Unconfigure ME

ASF Configuration

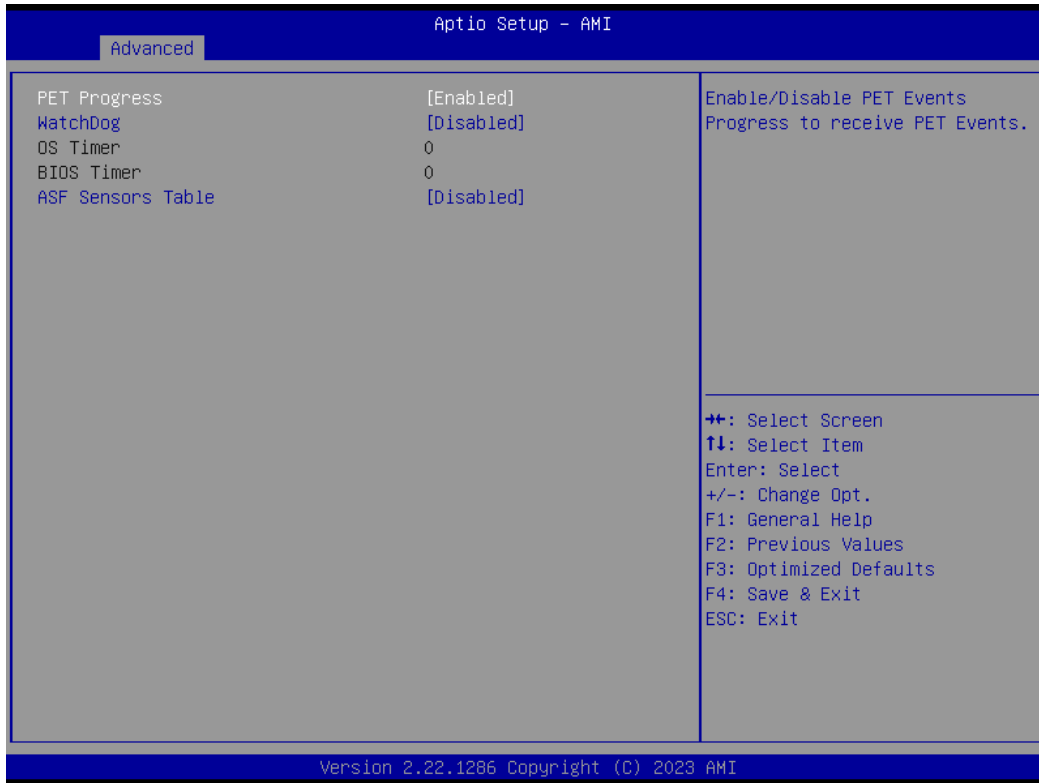

Item	Description
PET Progress	Choose to receive PET events or not Disabled : Disables PET Progress Enabled : Enables PET Progress (Default setting)
Watchdog	Choose to enables watchdog timer or not Disabled : Disables watchdog Timer (Default setting) Enabled : Enables watchdog Timer
OS Timer	Sets OS Watchdog Timer.
BIOS Timer	Sets BIOS Timer.
ASF Sensors Table	Disabled : Disables ASF Sensors Table (Default setting) Enabled : Enables ASF Sensors Table

Secure Erase Configuration

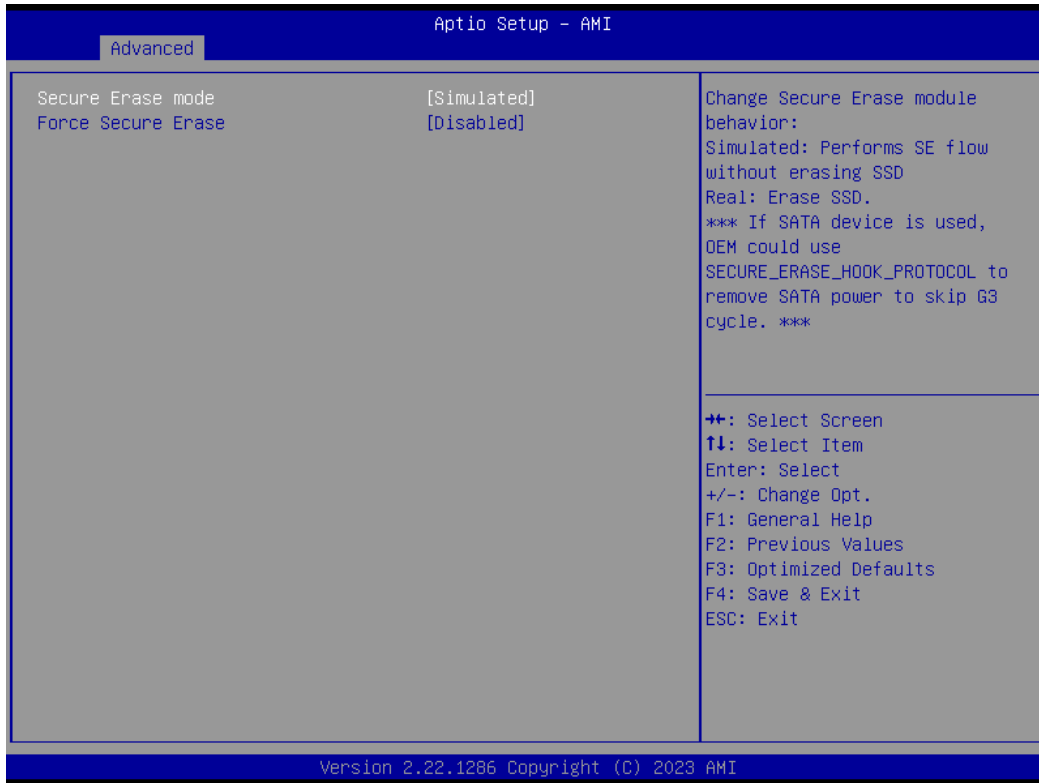

Item	Description
Secure Erase mode	Choose to enables secure erase mode or not. Simulated : Performs SE flow without erasing SSD (Default setting) Real : Erase SSD
Force Secure Erase	Force Secure Erase on next boot. Disabled : Disables Force Secure Erase (Default setting) Enabled : Enables Force Secure Erase

One Click Recovery (OCR) Configuration

(This item will appear when assembling i7/i5/i3 CPU)

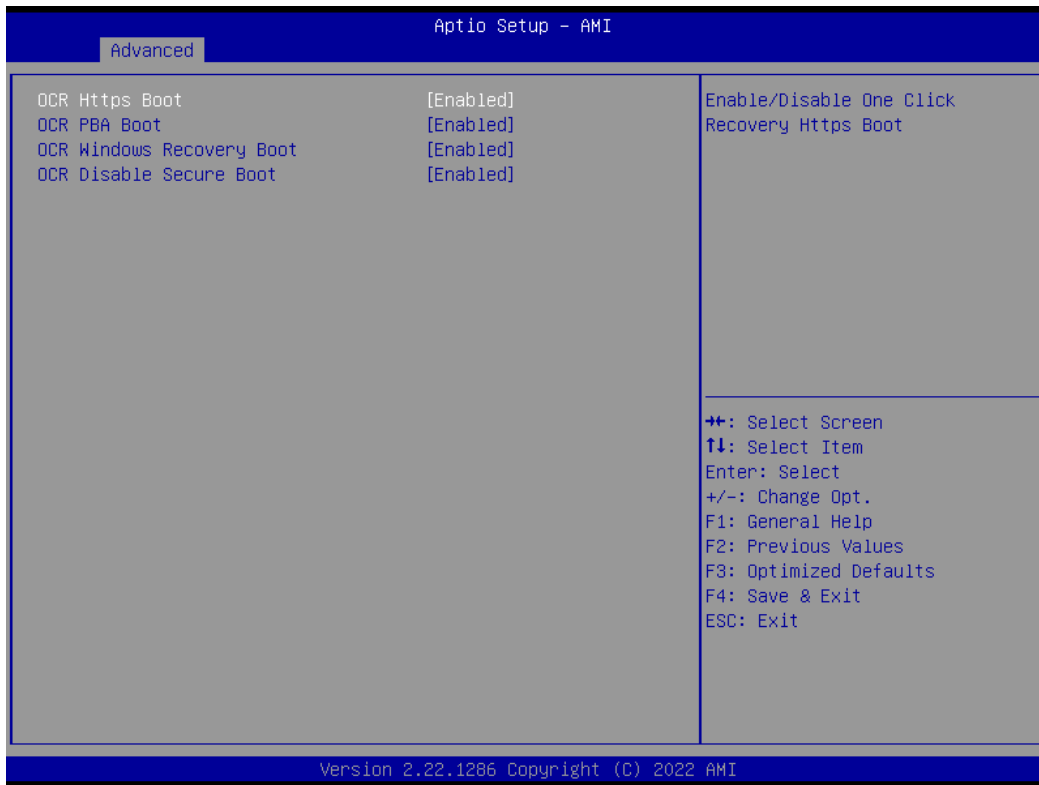

Item	Description
OCR Https Boot	Enabled : Enables One Click Recovery Https Boot. (Default setting) Disabled : Disables One Click Recovery Https Boot.
OCR PBA Boot	Enabled : Enables One Click Recovery PBA Boot. (Default setting) Disabled : Disables One Click Recovery PBA Boot.
OCR Windows Recovery Boot	Enabled : Enables One Click Recovery Windows recovery boot. (Default setting) Disabled : Disables One Click Recovery Windows recovery boot.
OCR Disable Secure Boot	Allows CSME to request Secureboot to be disabled for One Click Recovery. Enabled : Enables One Click Recovery disable Secure Boot function. (Default setting) Disabled : Disables One Click Recovery disable Secure Boot function.

2.2 TPM configuration

Use TPM Configuration submenu to choose TPM interface.

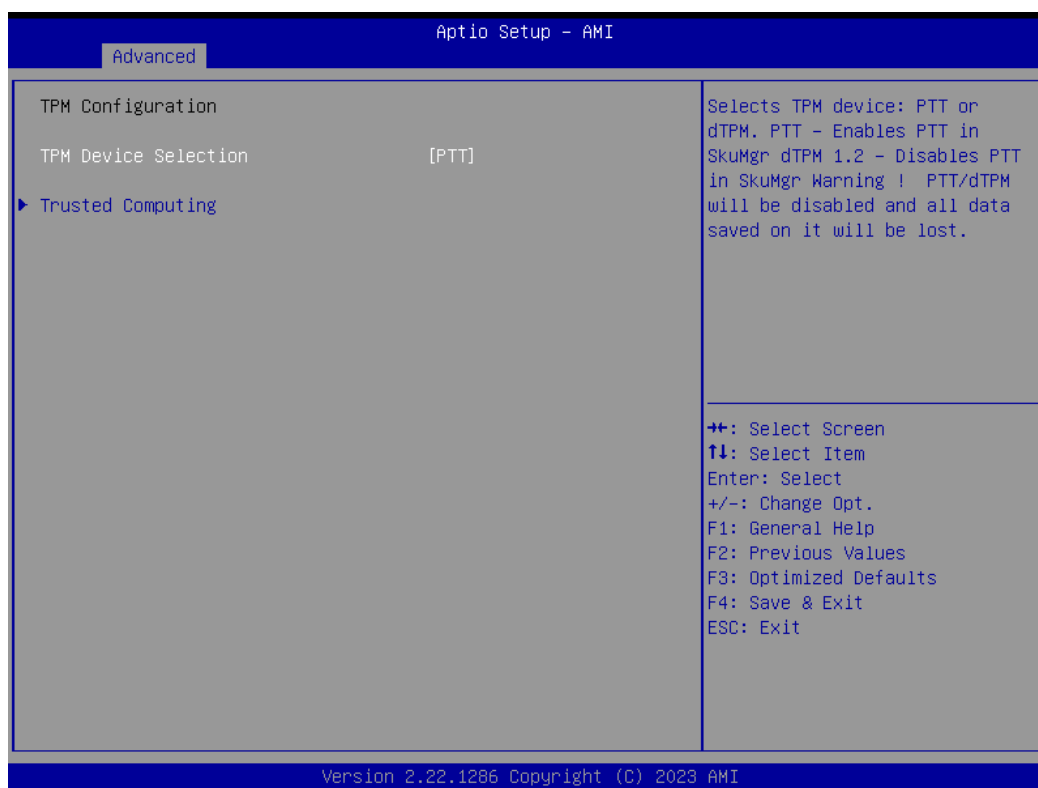

Item	Description
TPM Device Selection	PTT : Internal TPM (Default setting) dTPM : External TPM (When using External TPM module or having TPM chip on MB)

Trusted Computing : Shows TPM information, and TPM module configuration setting.

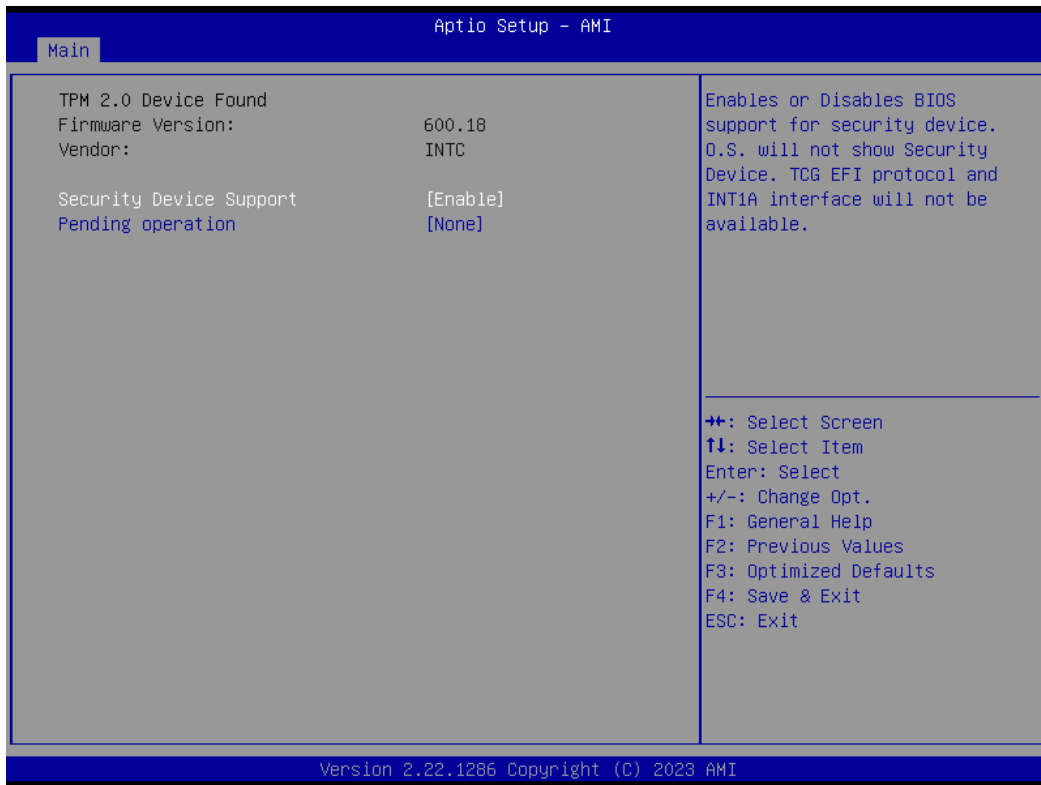

Item	Description
Security Device Support	Enabled : Enables TPM feature (Default setting) Disabled : Disables TPM feature
Pending operation	None : No execution will be conducted (Default setting) TPM clear : Set to clear data on TPM

2.3 CPU Configuration

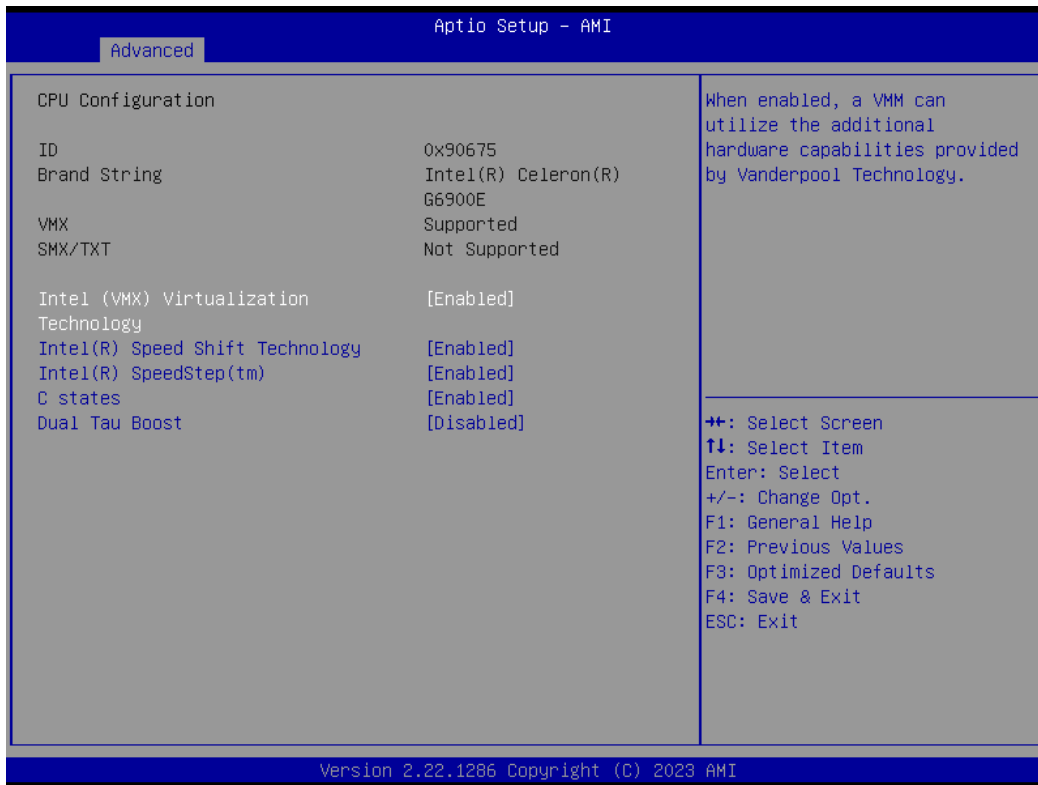

Item	Description
Intel (VMX) Virtualization Technology	Virtualization enhanced by Intel® Virtualization Technology will allow a platform to run multiple operating systems and applications in independent partitions. With virtualization, one computer system can function as multiple virtual systems. Enabled : Enables Intel Virtualization Technology (Default setting) Disabled : Disables Intel Virtualization Technology
Intel(R) Speed Shift Technology	To speed up CPU frequency transition time from basic frequency to maximum frequency. Enabled : Enables Intel(R) Speed Shift Technology Interrupt control (Default setting) Disabled : Disables Intel(R) Speed Shift Technology Interrupt control
Intel(R) SpeedStep(tm)	According to Intel CPU loading, Intel SpeedStep Technology will automatically adjust the CPU voltage and core frequency to decrease heat and power consumption for power saving. Enabled : Enables Intel SpeedStep Technology (Default setting) Disabled : Disables Intel SpeedStep Technology
C states	Command CPU to enter into low power consumption mode when CPU is under idle mode. Enabled : Enables CPU C states function (Default setting) Disabled : Disables CPU C states function
Dual Tau Boost	To optimize CPU performance. Enabled : Enables Dual Tau Boost function Disabled : Disables Dual Tau Boost function (Default setting)

2.4 SATA Configuration

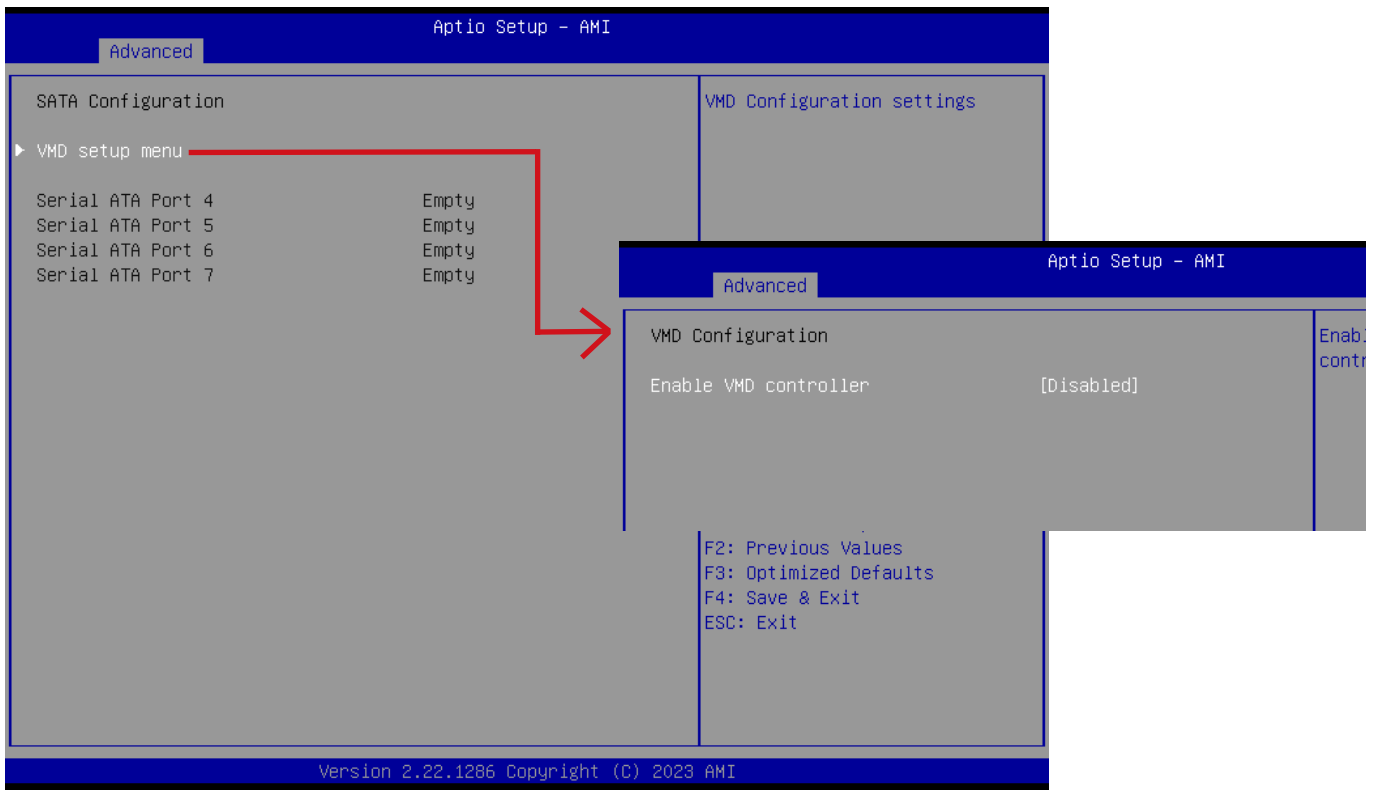

Item	Description
VMD setup menu / Enable VMD controller	Intel VMD feature helps you to control and manage NVMe PCIe SSD. Enabled : Enables Intel VMD feature Disabled : Disables Intel VMD feature (Default setting)
Serial ATA Port 4	shows 2.5" SATA HDD/SSD information
Serial ATA Port 5	
Serial ATA Port 6	
Serial ATA Port 7	

2.5 IT5782 Super IO Configuration



Item	Description
Super IO Chip	Shows Super I/O chip model
Serial Port 1 Configuration Serial Port 2 Configuration	<p>Press [Enter] to configure advanced items :</p> <p>Serial Port : Enabled : Enables allows you to configure the serial port settings Disabled : if Disabled, displays no configuration for the serial port</p> <p>Device settings : Display the specified Serial Port base I/O address and IRQ</p> <p>COM Port Mode : Choose RS-232, RS-422, or RS-485 feature</p>
Serial Port 3 Configuration Serial Port 4 Configuration	<p>Press [Enter] to configure advanced items :</p> <p>Serial Port : Enabled : Enables allows you to configure the serial port settings Disabled : if Disabled, displays no configuration for the serial port</p> <p>Device settings : Display the specified Serial Port base I/O address and IRQ</p>

2.6 Hardware Monitor

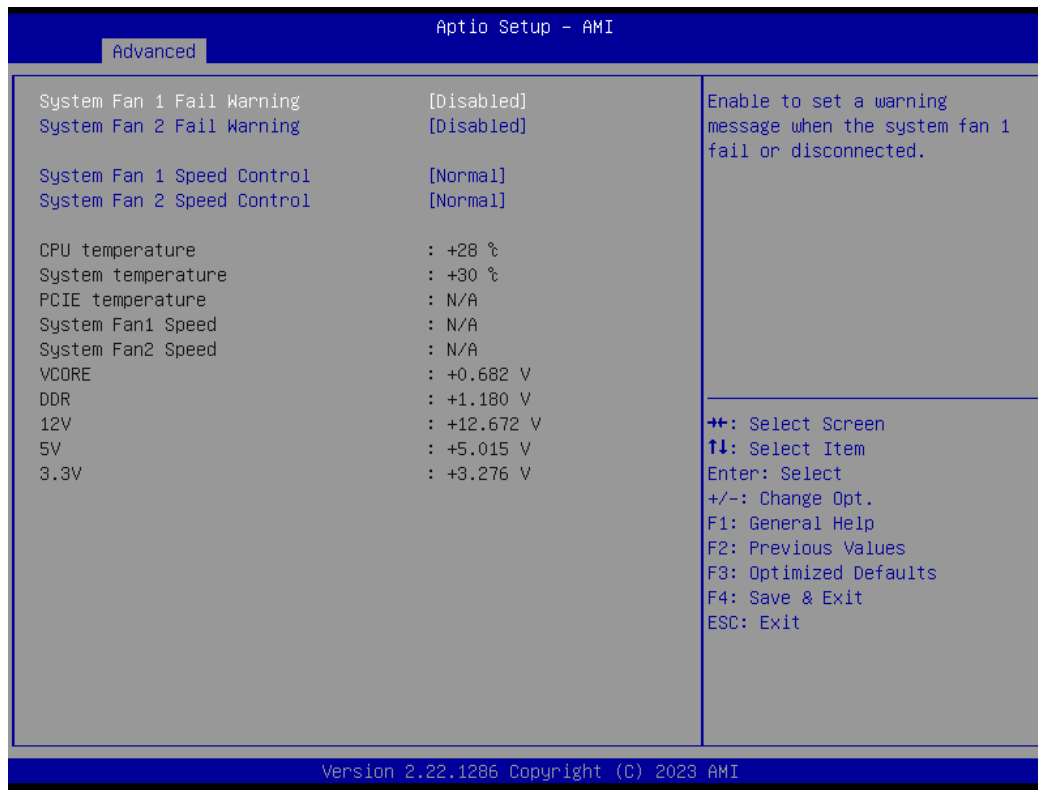

Item	Description
System Fan 1 Fail Warning	Enabled : Enables System FAN 1 Fail warning alert function Disabled : Disables System FAN 1 Fail warning alert function (Default setting) (This setting will effect only if you add the extend kit on the system)
System Fan 2 Fail Warning	Enabled : Enables System FAN 2 Fail warning alert function Disabled : Disables System FAN 2 Fail warning alert function (Default setting) (This setting will effect only if you add the extend kit on the system)
System Fan 1 Speed Control	Normal : Fan speed set by BIOS default (Default setting) Full Speed : Set Fan operates at full speed (This setting will effect only if you add the extend kit on the system)
System Fan 2 Speed Control	Normal : Fan speed set by BIOS default (Default setting) Full Speed : Set Fan operates at full speed (This setting will effect only if you add the extend kit on the system)
CPU temperature	Shows current CPU temperature
System temperature	Shows current System temperature
PCIe temperature	Shows current PCIe slot temperature for the extend kit of the system (This numerical value will shows only if you add the extend kit on the system)
System Fan1 Speed	Shows current System fan 1 Speed for the extend kit of the system (This numerical value will shows only if you add the extend kit on the system)
System Fan2 Speed	Shows current System fan 2 Speed for the extend kit of the system (This numerical value will shows only if you add the extend kit on the system)

2.7 S5 RTC Wake Settings



Item	Description
<p>Wake system from S5</p>	<p>Enable or Disable System to wake on a specific time. Disabled : Disables system to wake on a specific time (Default setting) Fixed Time : Enables system to wake on a specific time (Format : hr : min : sec)</p>

2.8 Network Stack Configuration

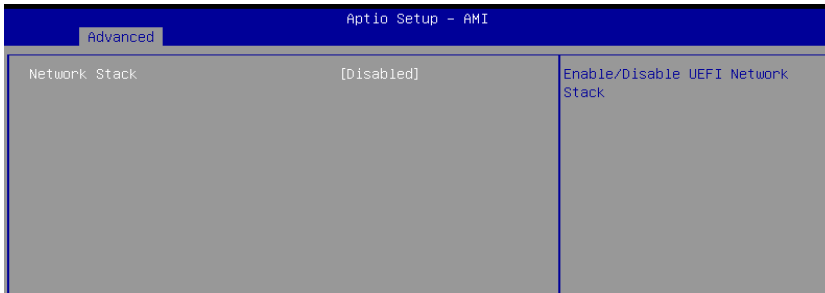

When Network stack is enabled :

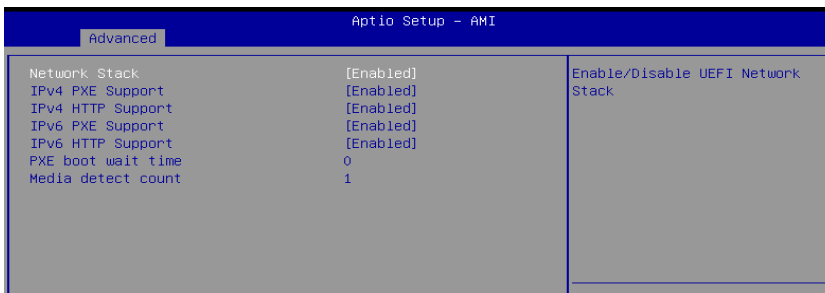

Item	Description
Network Stack	When system is power on, install LAN driver under UEFI mode Disabled : Disables UEFI Network Stack (Default setting) Enabled : Enables UEFI Network Stack
Ipv4 PXE Support	When Network stack is enabled : Disabled : Disables Ipv4 PXE Support Enabled : Enables Ipv4 PXE Support
IPv4 HTTP Support	When Network stack is enabled : Disabled : Disables IPv4 HTTP Support Enabled : Enables IPv4 HTTP Support
IPv6 PXE Support	When Network stack is enabled : Disabled : Disables IPv6 PXE Support Enabled : Enables IPv6 PXE Support
IPv6 HTTP Support	When Network stack is enabled : Disabled : Disables IPv6 HTTP Support Enabled : Enables IPv6 HTTP Support
PXE boot wait time	Wait time in seconds, or use ESC key to abort the PXE boot.
Media detect count	Number of times the presence of media will be checked.

2.9 NVMe Configuration

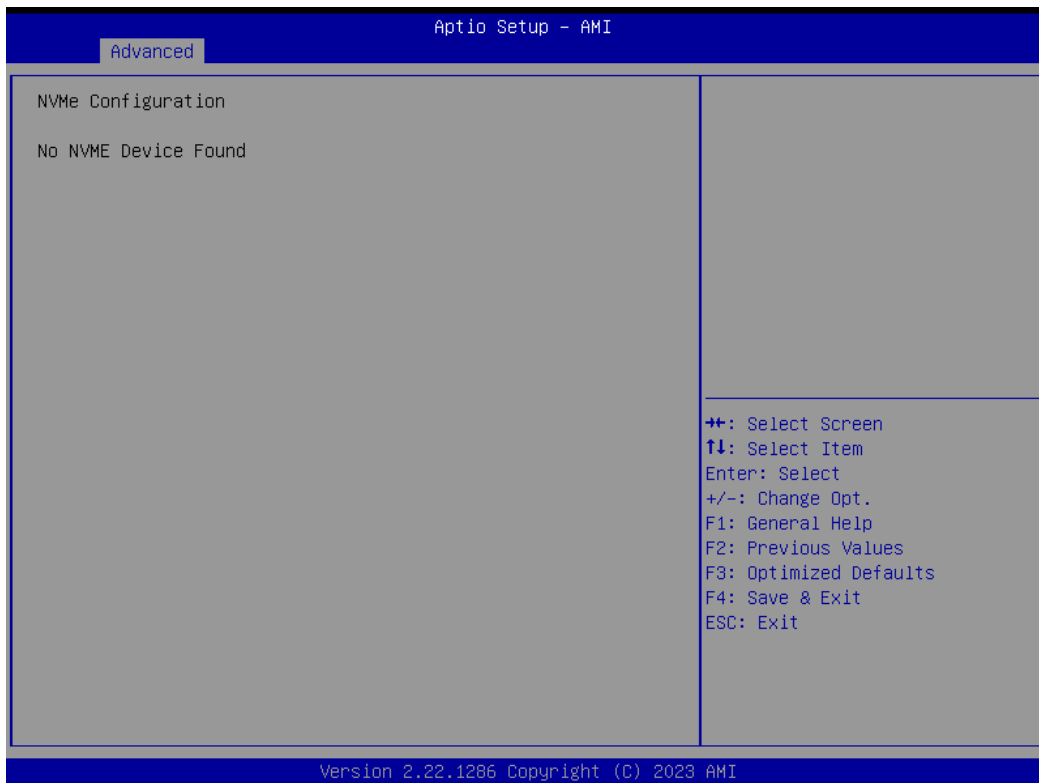

2.10 Offboard SATA Controller Configuration

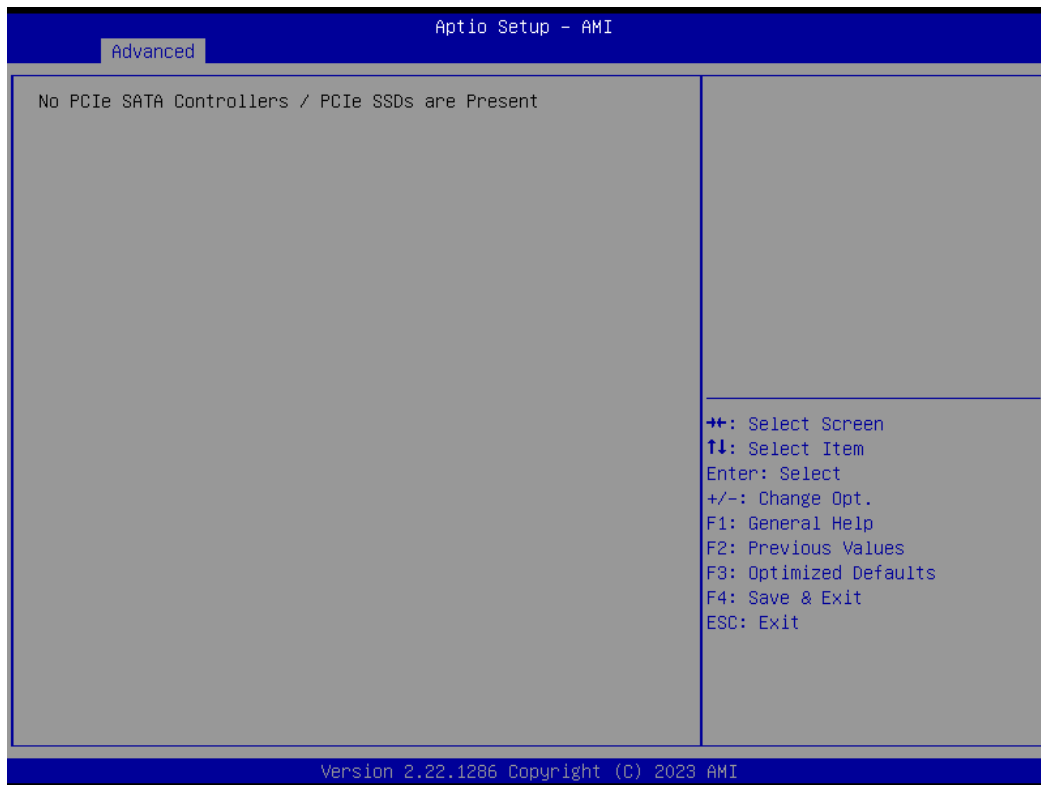

2.11 Tls Auth Configuration

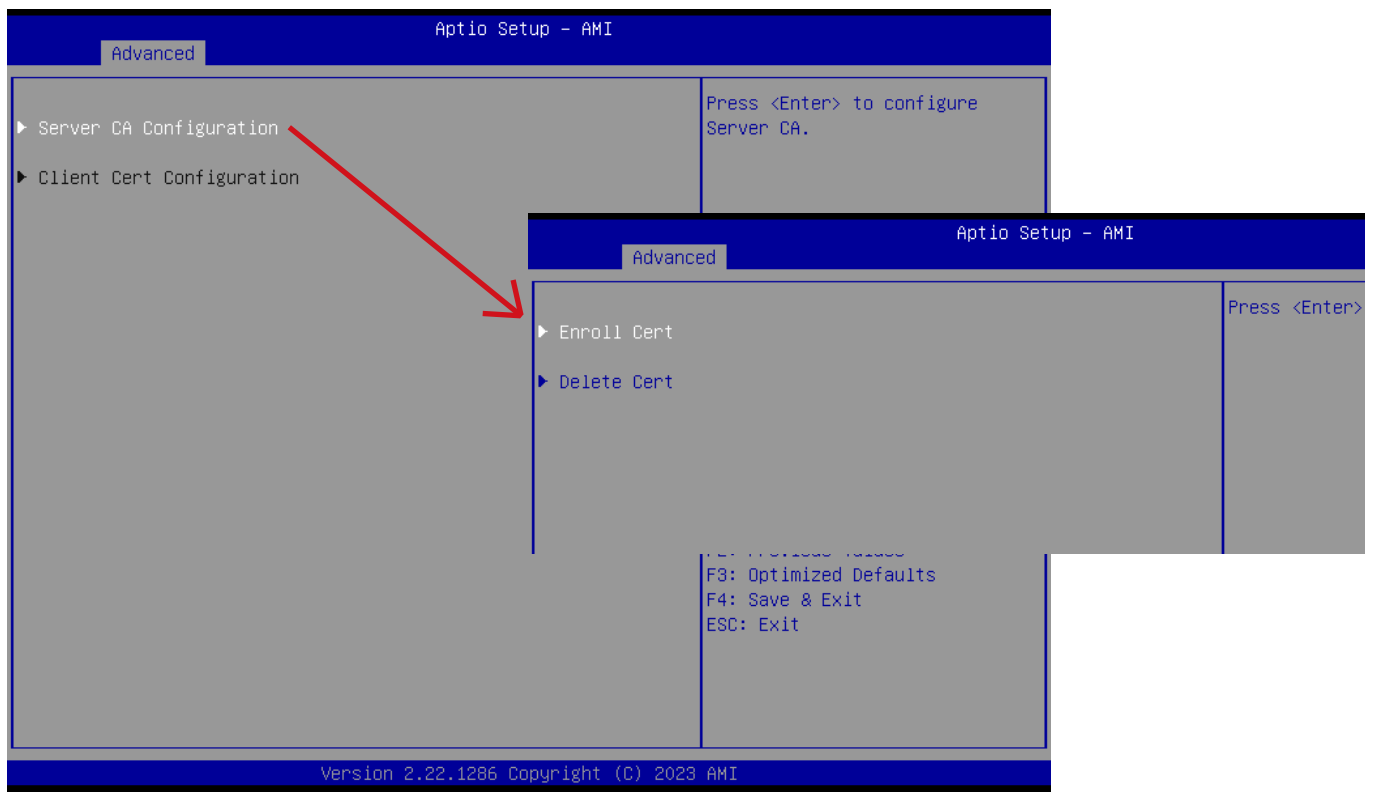

Item	Description
Enroll Cert	<p>Press [Enter] to configure advanced items :</p> <p>Server CA Configuration :</p> <p>Enroll Cert :</p> <ol style="list-style-type: none"> 1. Enroll Cert Using File 2. Cert GUID : Input digit character in 11111111-2222-3333-4444-1234567 890ab format. 3. Commit Changes and Exit 4. Discard Changes and Exit

3 Chipset

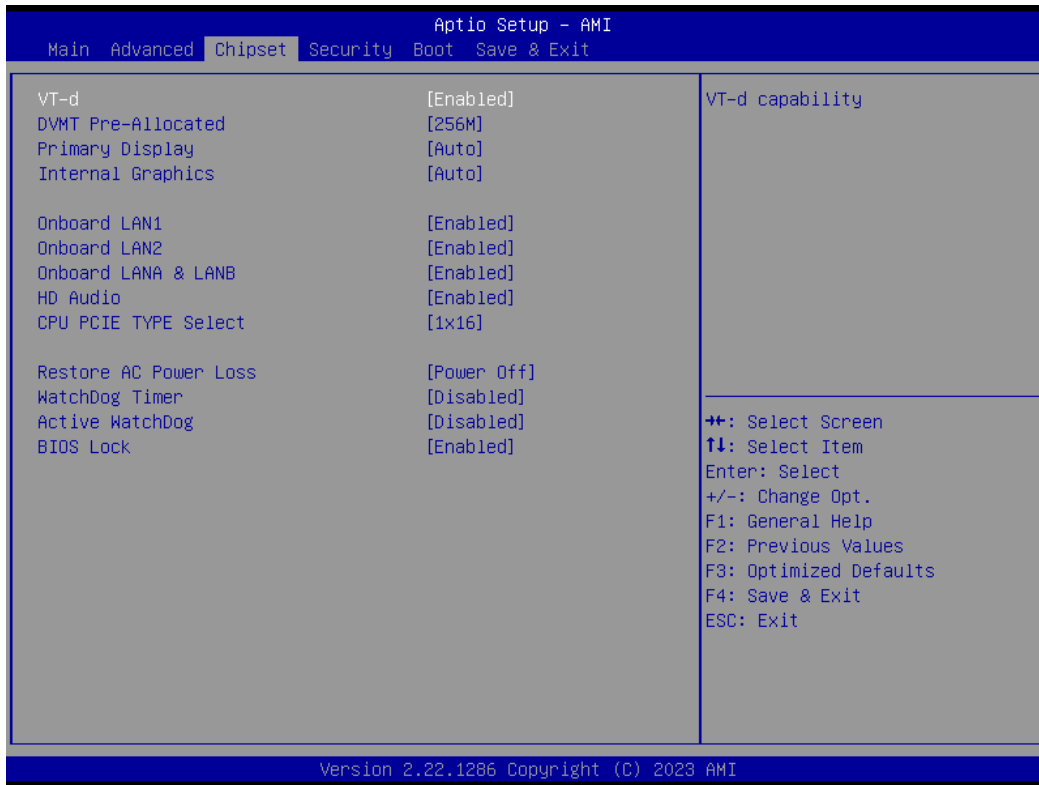

Item	Description
VT-d	Enabled : Enables VT-d function (Default setting) Disabled : Disables VT-d function
DVMT Pre-Allocated	Use DVMT Pre-Allocated to set the amount of system memory which is installed to the integrated graphics processor Option items : 32M , 64M, 128M, 256M(Default setting)
Primary Display	Auto : When detects PCIe Graphic card, primary display will set to PCIe (Default setting) IGFX : Force IGFX Graphic card as the primary display device PEG : Force PEG Graphic card as the primary display device
Internal Graphics	Enables or disables the onboard graphics function Auto : Detects display device automatically (Default setting) Enabled : Enables onboard graphics Disabled : Disables onboard graphics
Onboard LAN1 Onboard LAN2 Onboard LANA & LANB	Enable/Disable onboard LAN controller Enabled : Enables onboard LAN controller (Default setting) Disabled : Disables onboard LAN controller
HD Audio	Enable/Disable onboard audio controller Enabled : Enables onboard audio controller (Default setting) Disabled : Disables onboard audio controller
CPU PCIE TYPE Select	Option items: 1 x 16 : When installing only one external card on PCIe slot. 2 x 8 : When installing 2 external cards on PCIe slots. (This setting will effect only if you add the extend kit on the system)
Restore AC Power Loss	To set which option the system should returns if a sudden power loss occurred Power off : Do not power on when the power is back (Default setting) Power on : System power on when the power is back Last state : Restore the system to the state before power loss occurs
Watchdog Timer	Enable/Disable Watchdog Timer function Disabled : Disabled Watchdog Timer function (Default setting) Enabled : Enabled Watchdog Timer function
Active WatchDog	When the OS crashes, EC will auto restart the system. (only support for ACPI OS) Disabled : Disabled Active Watchdog function (Default setting) Enabled : Enabled Active Watchdog function
BIOS Lock	Enable/Disable BIOS Lock function Enabled : Enables BIOS Lock function (Default setting) Disabled : Disabled BIOS Lock funtion

4 Security

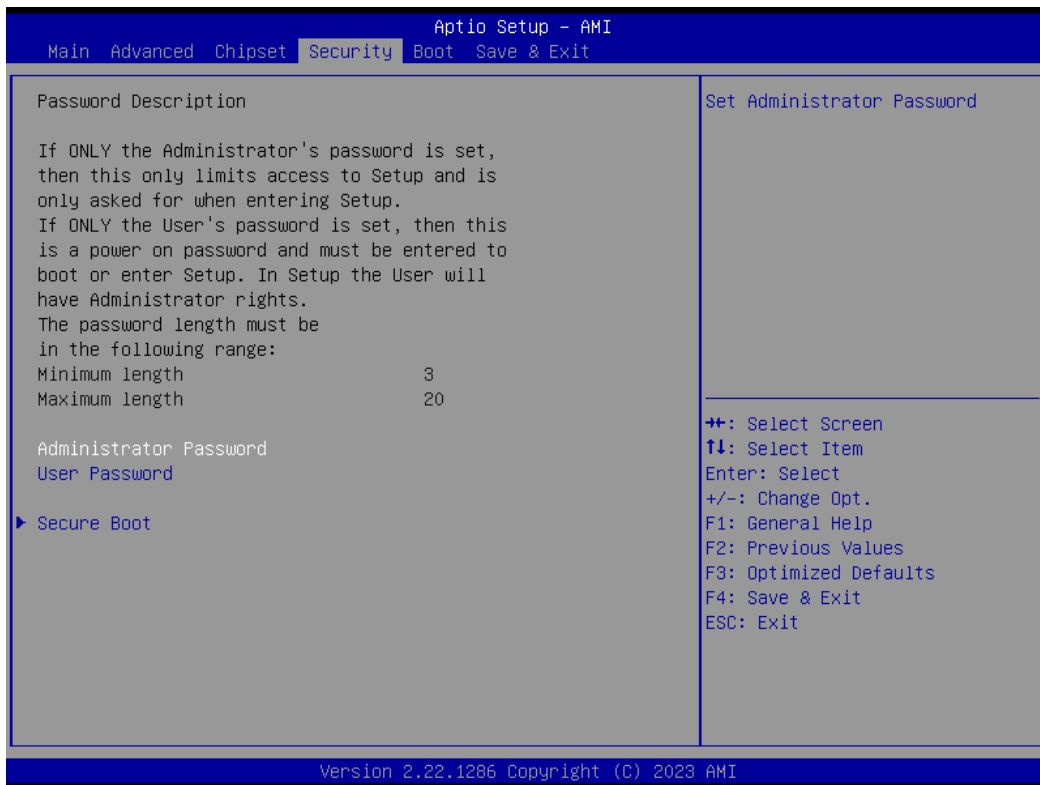

Item	Description
Administrator Password	To set up Administrator's password Minimum length : 3 Maximum length : 20
User Password	To set up User's password Minimum length : 3 Maximum length : 20
Secure Boot	Press <Enter> to configure the advanced items



Item	Description
Secure Boot	Secure Boot requires all the applications that are running during the booting process to be pre-signed with valid digital certificates Enabled : Enables Secure Boot function Disabled : Disables Secure Boot function (Default setting)
Secure Boot Mode	Standard : Standard mode Custom : Custom mode (Default setting)
Restore Factory Keys	To restore factory settings Yes : Agree to restore factory settings No : Cancel to restore factory settings
Reset To Setup Mode	Yes : Agree to setup mode No : Cancel to setup mode
Key Management	Enables expert users to modify Secure boot policy variables without full authentication Press <Enter> to configure the advanced items

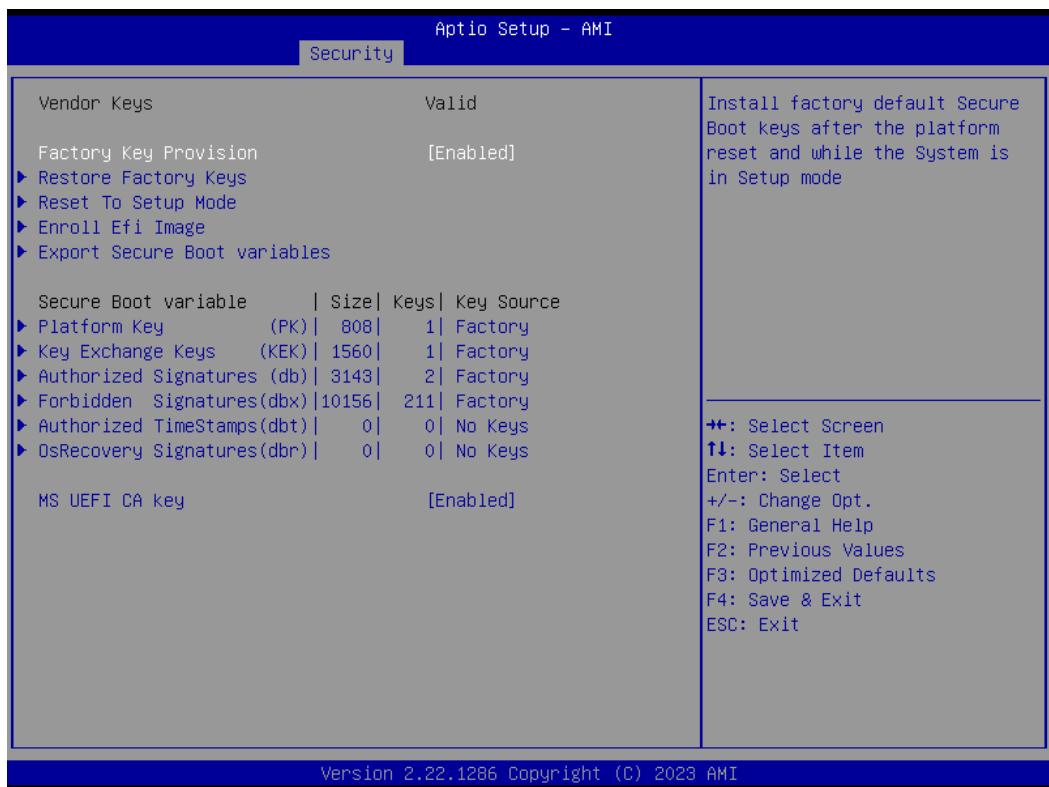

Item	Description
Factory Key Provision	Install factory default Secure Boot keys after the platform reset and while the system is in Setup mode Enabled : Enables Factory Key Provision (Default setting) Disabled : Disables Factory Key Provision
Restore Factory Keys	To restore factory settings Yes : Agree to restore factory settings No : Cancel to restore factory settings
Reset To Setup Mode	Yes : Agree to setup mode No : Cancel to setup mode
Enroll Efi Image	Allow the image to run in Secure Boot mode
Export Secure Boot variables	Copy NVRAM content of Secure Boot variables to files in a root folder on a file system device

Item	Description
Platform Key (PK)	These items allows you to enroll factory defaults or load Certificates from a file.
Key Exchange Keys	
Authorized Signatures	
Forbidden Signatures	
Authorized TimeStamps	
OsRecovery Signatures	
MS UEFI CA Key	Device Guard ready system must not list 'Microsoft UEFI CA' Certificate in Authorized Signature database(db)

5 Boot

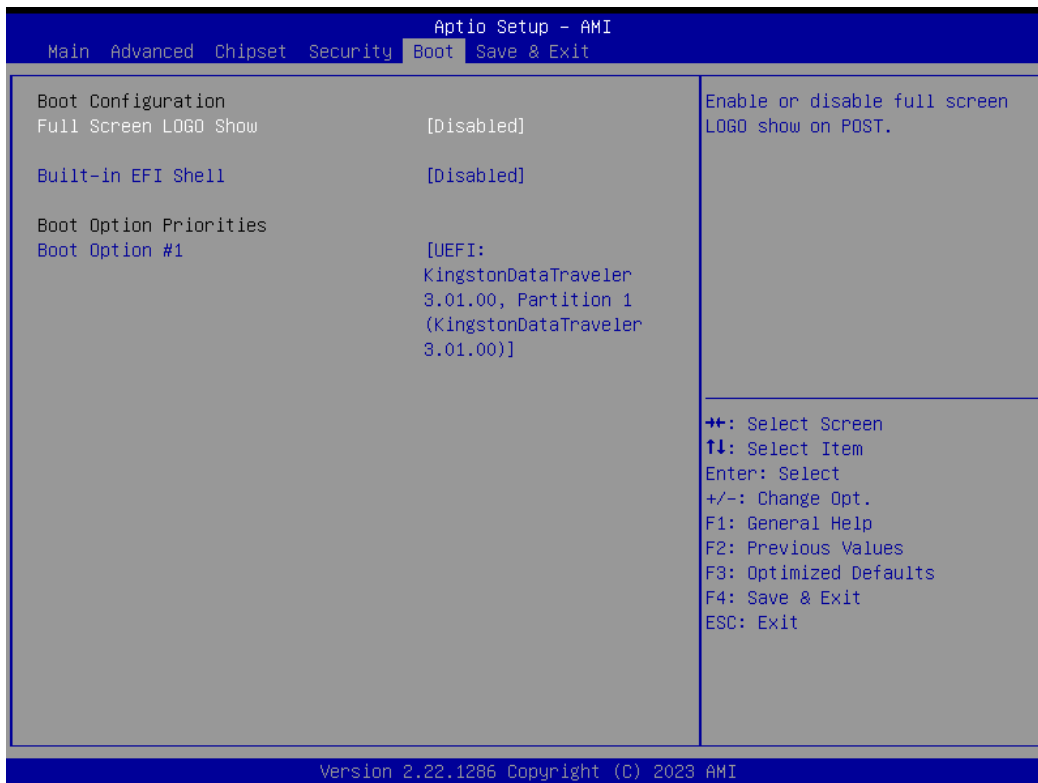

Item	Description
Full Screen LOGO Show	Enable/Disable full screen LOGO show on POST screen Enabled : Enables Full screen LOGO Show on POST screen (Default setting) Disabled : Disables Full screen LOGO Show on POST screen
Built-in EFI Shell	Enable/Disable Built-in EFI Shell Enabled : Enables Built-in EFI Shell Disabled : Disables Built-in EFI Shell (Default setting)
Boot Option #1	Shows the information of the storage that be installed in the system Choose/set the boot priority

6 Save & Exit



Item	Description
Save Changes and Reset	After configuring all the options that you wish to change, choose this option to save all the changes and reboot the system Yes : Agree to save and reset No : Cancel to save and reset
Discard Changes and Reset	Choose this option to reboot the system without saving any changes Yes : Agree to discard changes and reset No : Cancel to discard changes and reset
Restore Defaults	Restore/Load default values for all the setup options Yes : Agree to load optimized defaults No : Cancel to load optimized defaults
Me FW Image Re-Flash	Enable/Disable Me FW image re-flash function Enabled : Enables Me FW image re-flash function Disabled : Disables Me FW image re-flash function (Default setting)