



PIO-D144/D168 Series Card User Manual

144/168-channel DIO board

Version 3.4, Jun. 2018

SUPPORTS

This manual relates to the following boards:

PIO-D144 series	PIO-D144, PIO-D144U, PIO-D144LU, PEX-D144LS
PIO-D168 series	PIO-D168, PIO-D168A, PIO-D168U

WARRANTY

All products manufactured by ICP DAS are warranted against defective materials for a period of one year from the date of delivery to the original purchaser.

WARNING

ICP DAS assumes no liability for damages consequent to the use of this product. ICP DAS reserves the right to change this manual at any time without notice. The information furnished by ICP DAS is believed to be accurate and reliable. However, no responsibility is assumed by ICP DAS for its use, nor for any infringements of patents or other rights of third parties resulting from its use.

COPYRIGHT

Copyright © 2018 by ICP DAS. All rights are reserved.

TRADEMARK

Names are used for identification only and may be registered trademarks of their respective companies.

CONTACT US

If you have any question, please feel to contact us. We will give you quick response within 2 workdays.

Email: service@icpdas.com, service.icpdas@gmail.com

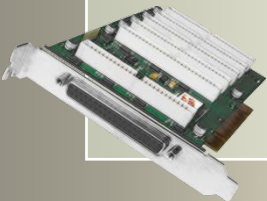
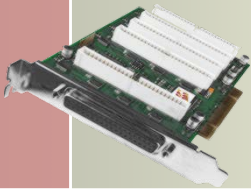

TABLE OF CONTENTS

PACKING LIST	3
1. INTRODUCTION	4
1.1 FEATURES.....	6
1.2 SPECIFICATIONS	7
1.2.1 PEX-D144LS, PIO-D144LU, PIO-D144(U).....	7
1.2.2 PIO-D168(U).....	8
2. HARDWARE CONFIGURATION	9
2.1 BOARD LAYOUT	9
2.2 I/O PORT LOCATION.....	11
2.3 CARD ID SWITCH.....	13
2.4 PIN ASSIGNMENTS	14
2.4.1 PIO-D144/D44U/D144LU/D168/D168U.....	14
2.4.2 PEX-D144LS.....	15
2.5 ENABLE I/O OPERATION	16
2.6 DI/DO ARCHITECTURE	17
2.7 INTERRUPT OPERATION	18
3. HARDWARE INSTALLATION	19
4. SOFTWARE INSTALLATION	23
4.1 OBTAINING/INSTALLING THE DRIVER INSTALLER PACKAGE	23
4.2 PNP DRIVER INSTALLATION	26
4.3 VERIFYING THE INSTALLATION	28
4.3.1 Accessing Windows Device Manager.....	28
4.3.2 Check that the Installation	31
5. BOARD TESTING	32
5.1 SELF-TEST WIRING.....	32
5.1.1 PIO-D144/D144U/D144LU/D168/D168U.....	32
5.1.2 PEX-D144LS.....	33
5.2 LAUNCH THE TEST PROGRAM	34
6. I/O CONTROL REGISTER	37
6.1 HOW TO FIND THE I/O ADDRESS	37
6.2 THE ASSIGNMENT OF I/O ADDRESS.....	41

6.3	THE I/O ADDRESS MAP	43
6.3.1	RESET\ Control Register.....	44
6.3.2	AUX Control Register	44
6.3.3	Aux Data Register	45
6.3.4	INT Mask Control Register.....	45
6.3.5	Aux Status Register.....	46
6.3.6	Interrupt Polarity Register	46
6.3.7	Read/Write 8-bit Data Register	47
6.3.8	Active I/O Port Control Register.....	47
6.3.9	I/O Selection Control Register.....	48
6.3.10	Card ID Register.....	49
7.	DEMO PROGRAMS	50
7.1	DEMO PROGRAM FOR WINDOWS	50
7.2	DEMO PROGRAM FOR DOS.....	52
	APPENDIX: DAUGHTER BOARD	53
A1.	DB-37, DN-37, DN-50 and DN-100	53
A2.	DB-8125.....	54
A3.	ADP-37/PCI and ADP-50/PCI.....	54
A4.	DB-24P and DB-24PD Isolated Input Board.....	55
A5.	DB-24R and DB-24RD Relay Board.....	56
A6.	DB-24PR, DB-24POR and DB-24C.....	57
A7.	Daughter Boards Comparison Table.....	58

Packing List

The shipping package includes the following items:

One PIO-D144 or PIO-D168 Series card as follows:



PIO-D144/D144U/D144LU



PEX-D144LS

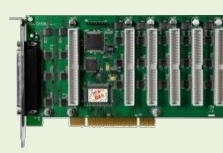

PIO-D168/168U

One printed Quick Start Guide

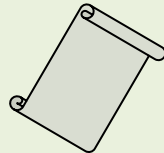

One Software Utility CD



Note:

If any of these items is missing or damaged, contact the dealer from whom you purchased the product. Save the shipping materials and carton in case you need to ship or store the product in the future.

1. Introduction

➤ General Description

The PEX-D144LS, PIO-D144(L)U and PIO-D168U cards are the new generation product that ICP DAS provides to meet RoHS compliance requirement, and is designed as an easy replacement for the PIO-D144 and PIO-D168, without requiring any modification to the software or the driver.

The PIO-D144(L)U/D168U universal PCI card supports 3.3 V/5 V PCI bus while the PEX-D144LS supports PCI Express bus. These cards provide 144/168 TTL Digital I/O lines that consist of 18/21 8-bit bi-directional ports. Each group of three 8-bit ports is arranged on the connector as Port A (PA), Port B (PB) and Port C (PC), respectively, and all ports are configured as inputs ports on power-up or after a reset.

The PEX-D144LS provides a high-density connector that reduces the amount of installation space required for the card in the computer.

The PIO-D144(L)U/D168U and PEX-D144LS cards include an onboard Card ID switch that enables the board to be recognized via software if two or more boards are installed in the same computer. The PIO-D144LU and PEX-D144LS also adds pull-high/low jumpers allow the DI status to be predefined instead of remaining floating if the DI channels are disconnected or interrupted.

These cards support various OS versions, such as Linux, DOS and 32/64-bit Windows XP/2003/2008/7/8/10. DLL and Active X control together with various language sample programs based on Turbo C++, Borland C++, Microsoft C++, Visual C++, Borland Delphi, Borland C++ Builder, Visual Basic, C#.NET, Visual Basic.NET and LabVIEW are provided in order to help users quickly and easily develop their own applications.

➤ **Comparison Table**

Model	Interface	Channels	DI Pull-High/Low	Card ID	Compatibility	Advantage
PEX-D144LS	PCI Express	144	Yes	Yes	5 V/CMOS	Low power consumption Low temperature
PIO-D144LU	Universal PCI	144	Yes	Yes	5 V/CMOS	Low power consumption Low temperature
PIO-D144U	Universal PCI	144	No	Yes	5 V/TTL	High DO Driving (Output Capability)
PIO-D168U	Universal PCI	168	No	Yes	5 V/TTL	High DO Driving (Output Capability)

➤ **Phased-out models:**

Model	Interface	Channels	DI Pull-High/Low	Card ID	Compatibility	Advantage
PIO-D144	PCI Bus	144	No	No	5 V/TTL	High DO Driving (Output Capability)
PIO-D168 PIO-D168A	PCI Bus	168	No	No	5 V/TTL	High DO Driving (Output Capability)

1.1 Features

[PIO-D144/D144U/D144LU, PEX-D144LS]

- Support the +5V PCI bus for PIO-D144
- Support the +3.3/+5 V PCI bus for PIO-D144U/D144LU
- Support the PCI Express x 1 for PEX-D144LS
- 144 channels of digital I/O
- 18 8-bit bi-direction I/O ports
- Pull-high/Pull-low Jumpers for DI Channels for PIO-D144LU/PEX-D144LS
- Card ID function for PIO-D144U/D144LU and PEX-D144LS
- PIO-D144/D144U/D144LU: Five 50-pin flat cable connectors and one 37-pin connector
- PEX-D144LS: One SCSI II 100-pin connector and one 5-pin flat cable connector.
- PIO-D144/D144U/D144LU: DIO response time is about 1 μ s (1MHz)
- PEX-D144LS: DIO response time is about 500 kHz

[PIO-D168/D168U]

- Support the +5V PCI bus for PIO-D168
- Support the +3.3/+5 V PCI bus for PIO-D168U
- 168 channels of digital I/O
- 21 8-bit bi-direction I/O ports
- Card ID function for PIO-D168U
- Six 50-pin flat cable connectors and one 37-pin connector
- DIO response time is about 1 μ s (1MHz)

[Common Functions]

- Bi-direction programmable I/O ports under software control
- 4 Interrupt source: P2C0, P2C1, P2C2, P2C3
- Output status Readback function
- Connects directly to DB-24P, DB-24R, DB-24PR, DB-24SSR, DB-24POR any other OPTO-22 Compatible daughter boards
- Double side SMT, short card, power saving

1.2 Specifications

1.2.1 PEX-D144LS, PIO-D144LU, PIO-D144(U)

Model Name	PEX-D144LS	PIO-D144LU	PIO-D144U	PIO-D144 (Phased-out)
Programmable Digital I/O				
Channels	144			
Digital Input				
Compatibility	5 V/CMOS		5 V/TTL	
Input Voltage	Logic 0: 0.8 V max. Logic 1: 2.0 V min.			
Response Speed	500 kHz	1 MHz		
Digital Output				
Compatibility	5 V/CMOS		5 V/TTL	
Output Voltage	Logic 0: 0.1 V max. Logic 1: 4.4 V min.		Logic 0: 0.4 V max. Logic 1: 2.4 V min.	
Output Capability	Sink: 6 mA @ 0.33 V Source: 6 mA @ 4.77 V		Sink: 64mA @ 0.8 V Source: 32 mA @ 2.0 V	
Response Speed	500 kHz	1 MHz		
General				
Bus Type	PCI Express x 1	3.3 V/5 V Universal PCI, 32-bit, 33 MHz	5 V PCI, 32-bit, 33 MHz	
Data Bus	8-bit			
Card ID	Yes(4-bit)			No
I/O Connector	Female SCSI II 100-pin x 1 50-pin box header x 1	Female DB37 x 1 50-pin box header x 5		
Dimensions (L x W x D)	162 mm x 100 mm x 22 mm	180 mm x 105 mm x 22mm		
Power Consumption	750 mA @ +3.3 V 0 mA @ +12 V	250 mA @ +5 V	600 mA @ +5 V	
Operating Temperature	0 ~ 60 °C			
Storage Temperature	-20 ~ 70 °C			
Humidity	5 ~ 85% RH, non-condensing			

Note:

The I/O speed is depending on I/O card, bus speed, CPU speed and system loading. Any condition changes may cause the I/O speed different.

1.2.2 PIO-D168(U)

Model Name	PIO-D168 (Phased-out)	PIO-D168U
Programmable Digital I/O		
Channels	168	
Digital Input		
Compatibility	5 V/TTL	
Input Voltage	Logic 0: 0.8 V max. Logic 1: 2.0 V min.	
Response Speed	1 MHz	
Digital Output		
Compatibility	5 V/TTL	
Output Voltage	Logic 0: 0.4 V max. Logic 1: 2.4 V min.	
Output Capability	Sink: 64mA @ 0.8 V Source: 32 mA @ 2.0 V	
Response Speed	1 MHz	
General		
Bus Type	5 V PCI, 32-bit, 33 MHz	3.3 V/5 V Universal PCI, 32-bit, 33 MHz
Data Bus	8-bit	
Card ID	No	Yes(4-bit)
I/O Connector	Female DB37 x 1 50-pin box header x 6	
Dimensions (L x W x D)	200 mm x 105 mm x 22mm	
Power Consumption	1300 mA @ +5 V	
Operating Temperature	0 ~ 60 °C	
Storage Temperature	-20 ~ 70 °C	
Humidity	5 ~ 85% RH, non-condensing	

Note:

The I/O speed is depending on I/O card, bus speed, CPU speed and system loading. Any condition changes may cause the I/O speed different.

2. Hardware Configuration

2.1 Board Layout

➤ **PIO-D144/D144U and PIO-D168/D168U:**

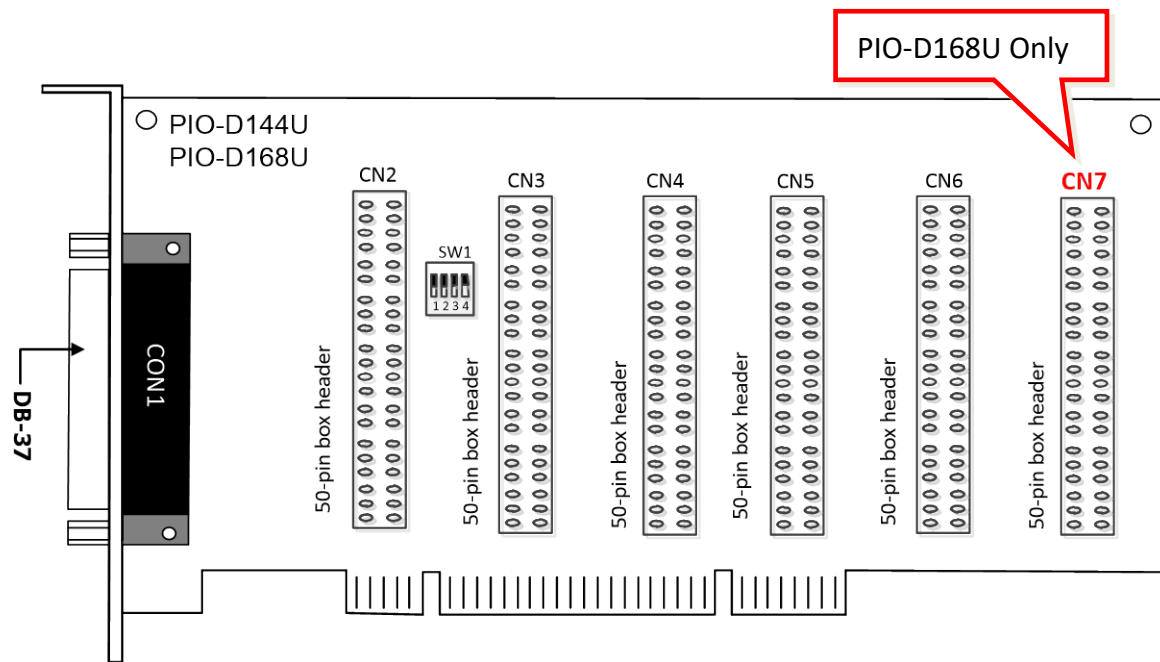
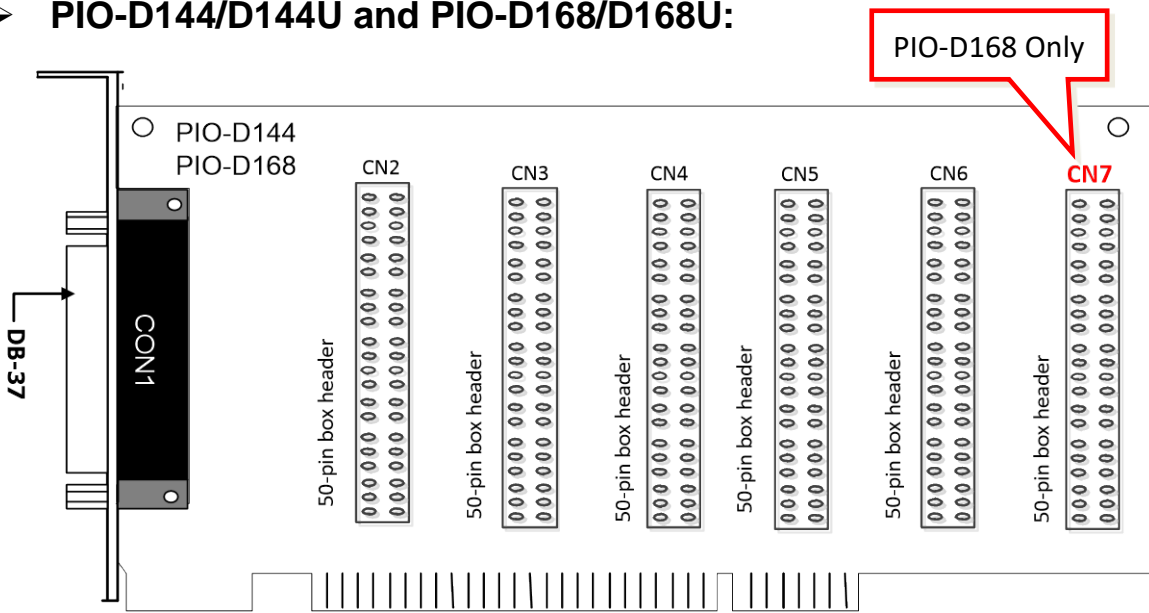

➤ **PIO-D144LU and PEX-D144LS:**

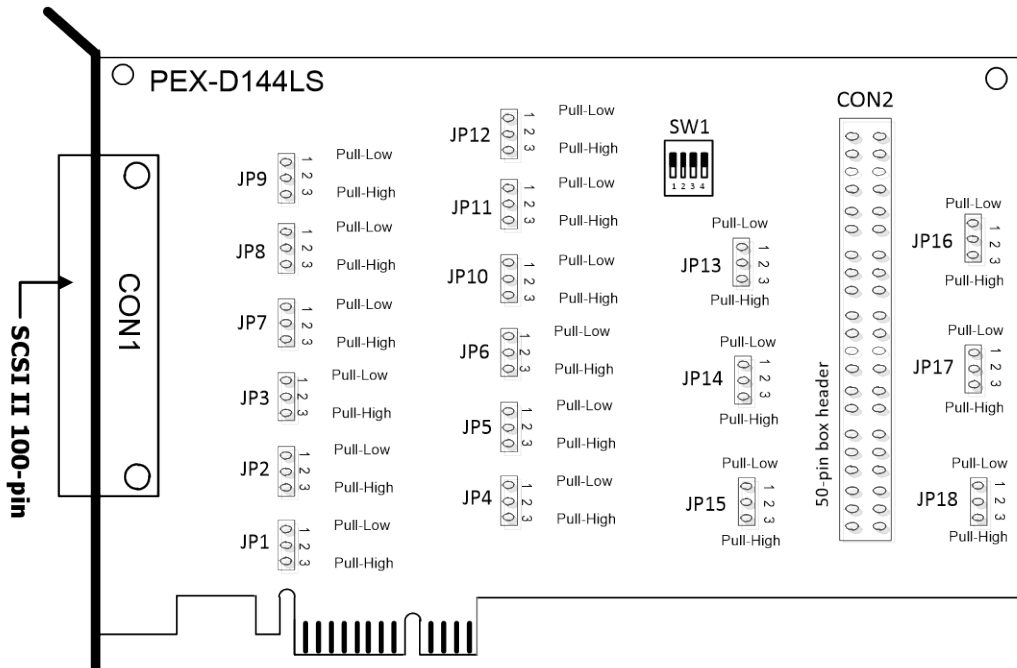
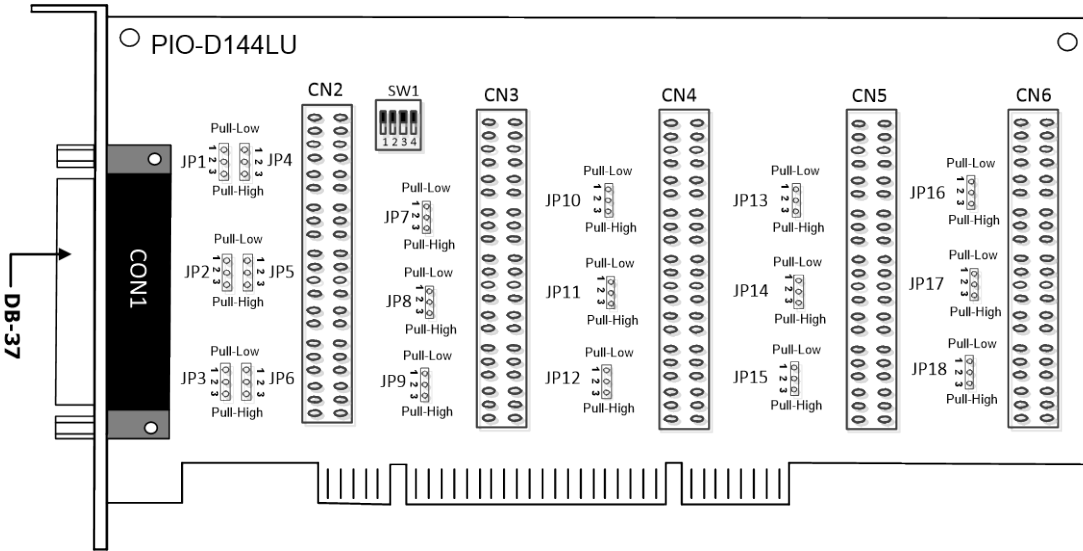

Note:

The JPx default settings: JP1/2/3/4/5/6/7/8/9/10/11/12/13/14/15/16/17/18 = 1-2 short = Pull-Low refer to [Section 2.2 "I/O Port Location"](#) for more detailed about DI pull-high/low information.

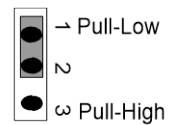

2.2 I/O Port Location

There are 18/21 8-bit I/O ports in the PIO-D144/D168 series boards. Every port can be independently configured as a DI or DO port. When the PC is first powered-on or reset, all ports are configured as Digital input ports. Therefore, the user needs to configure these ports as either digital input or output ports before using them in an application. Each I/O port is named as the following table and its location can be found in Table 2.1 to 2.3.

The PIO-D144LU and PEX-D144LS card supports pull-high/low jumpers allow the DI ports can be selected to either pull-high or pull-low via placement of the JP1 to JP18 jumpers. Please refer to Table 2.2 and 2.3 for more detailed information.

Table 2.1

Model		PIO-D144(U), PIO-D168(U)						PIO-D168(U)
Connector		CN1	CN2	CN3	CN4	CN5	CN6	CN7
PA0 ~ PA7	Port	Port0	Port3	Port6	Port9	Port14	Port15	Port18
PB0 ~ PB7	Port	Port1	Port4	Port7	Port10	Port13	Port16	Port19
PC0 ~ PC7	Port	Port2	Port5	Port8	Port11	Port14	Port17	Port20

Table 2.2

Model		PIO-D144LU					
Connector		CN1	CN2	CN3	CN4	CN5	CN6
PA0 ~ PA7	Port	Port0	Port3	Port6	Port9	Port14	Port15
	Pull-high/Low	JP1	JP4	JP7	PJ10	PJ13	PJ16
PB0 ~ PB7	Port	Port1	Port4	Port7	Port10	Port13	Port16
	Pull-high/Low	JP2	JP5	JP8	JP11	PJ14	PJ17
PC0 ~ PC7	Port	Port2	Port5	Port8	Port11	Port14	Port17
	Pull-high/Low	JP3	JP6	JP9	JP12	PJ15	PJ18

Notes:

1. This board is a bi-directional I/O design with default DI mode when power on. Before switching to DO mode, the DI pull-high jumper setting may activate active-high DO devices (e.g., DB-24R / 24PR / 24C), or the pull-low setting may activate active-low DO devices. Please have a appropriate jumper setting depending on the characteristics of your external device.
2. Each P2C0/P2C1/P2C2/P2C3 can be used as an interrupt signal source. Refer to [Section 2.7 "Interrupt Operation"](#) for more information.

Table 2.3

Model	PEX-D144LS		
	Connector	CON1	Connector
PA0~ PA7	Port0 (pull-high/low by JP1)	PA40 ~ PA47	Port12 (pull-high/low by JP13)
PB0 ~ PB7	Port1 (pull-high/low by JP2)	PB40 ~ PB47	Port13 (pull-high/low by JP14)
PC0 ~ PC7	Port2 (pull-high/low by JP3)	PC40 ~ PC47	Port14 (pull-high/low by JP15)
PA10 ~ PA17	Port3 (pull-high/low by JP4)	PA50 ~PA57	Port15 (pull-high/low by JP16)
PB10 ~ PB17	Port4 (pull-high/low by JP5)	PB50 ~ PB57	Port16 (pull-high/low by JP17)
PC10 ~ PC17	Port5 (pull-high/low by JP6)	PC50 ~ PC57	Port17 (pull-high/low by JP18)
PA20 ~ PA27	Port6 (pull-high/low by JP7)	-	-
PB20 ~ PB27	Port7 (pull-high/low by JP8)	-	-
PC20 ~ PC27	Port8 (pull-high/low by JP9)	-	-
PA30 ~ PA37	Port9 (pull-high/low by JP10)	-	-
PB30 ~ PB37	Port10 (pull-high/low by JP11)	-	-
PC30 ~ PC37	Port11 (pull-high/low by JP12)	-	-

Notes:

1. This board is a bi-directional I/O design with default DI mode when power on. Before switching to DO mode, the DI pull-high jumper setting may activate active-high DO devices (e.g., DB-24R / 24PR / 24C), or the pull-low setting may activate active-low DO devices. Please have a appropriate jumper setting depending on the characteristics of your external device.

2. Each P2C0/P2C1/P2C2/P2C3 can be used as an interrupt signal source. Refer to [Section 2.7 "Interrupt Operation"](#) for more information.

2.3 Card ID Switch

The PIO-D144U/D144LU, PEX-D144LS and PIO-D168U cards has a Card ID switch (SW1) with which users can recognize the board by the ID via software when using two or more PIO-D144U/D144LU, PEX-D144LS and PIO-D168U cards in one computer. The default Card ID is 0x0. For detailed information about the SW1 Card ID settings, refer to Table 2.4.

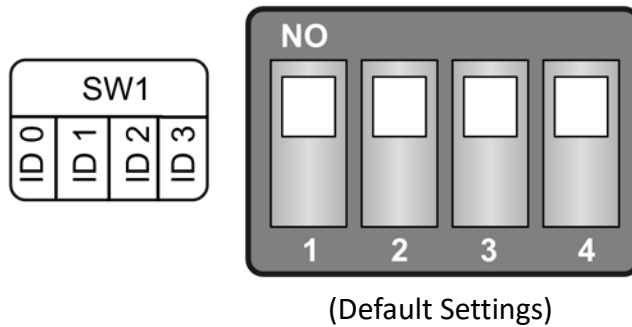

Table 2.4 (*) Default Settings; OFF → 1; ON → 0

Card ID (Hex)	1 ID0	2 ID1	3 ID2	4 ID3
(*) 0x0	ON	ON	ON	ON
0x1	OFF	ON	ON	ON
0x2	ON	OFF	ON	ON
0x3	OFF	OFF	ON	ON
0x4	ON	ON	OFF	ON
0x5	OFF	ON	OFF	ON
0x6	ON	OFF	OFF	ON
0x7	OFF	OFF	OFF	ON
0x8	ON	ON	ON	OFF
0x9	OFF	ON	ON	OFF
0xA	ON	OFF	ON	OFF
0xB	OFF	OFF	ON	OFF
0xC	ON	ON	OFF	OFF
0xD	OFF	ON	OFF	OFF
0xE	ON	OFF	OFF	OFF
0xF	OFF	OFF	OFF	OFF

2.4 Pin Assignments

2.4.1 PIO-D144/D44U/D144LU/D168/D168U

- CN1: 37-pin D-type female connector (for Port0 to Port2).
- CN2/CN3/CN4/CN5/CN6/CN7: 50-pin flat-cable connector (for Port3 to Port20).

Note: CN7 (Port8 ~ Port20) is only for the PIO-D168 series.

Pin Assignment	Terminal No.	Pin Assignment
N.C	01	
N.C.	02	20 +5V
PB_7	03	21 GND
PB_6	04	22 PC_7
PB_5	05	23 PC_6
PB_4	06	24 PC_5
PB_3	07	25 PC_4
PB_2	08	26 PC_3
PB_1	09	27 PC_2
PB_0	10	28 PC_1
GND	11	29 PC_0
N.C.	12	30 PA_7
GND	13	31 PA_6
N.C.	14	32 PA_5
GND	15	33 PA_4
N.C.	16	34 PA_3
GND	17	35 PA_2
+5V	18	36 PA_1
GND	19	37 PA_0

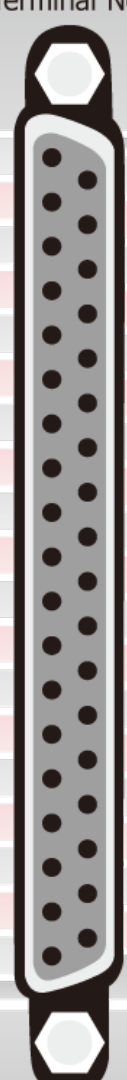

CN1

Pin Assignment	Terminal No.	Pin Assignment
PC_7	01	02 GND
PC_6	03	04 GND
PC_5	05	06 GND
PC_4	07	08 GND
PC_3	09	10 GND
PC_2	11	12 GND
PC_1	13	14 GND
PC_0	15	16 GND
PB_7	17	18 GND
PB_6	19	20 GND
PB_5	21	22 GND
PB_4	23	24 GND
PB_3	25	26 GND
PB_2	27	28 GND
PB_1	29	30 GND
PB_0	31	32 GND
PA_7	33	34 GND
PA_6	35	36 GND
PA_5	37	38 GND
PA_4	39	40 GND
PA_3	41	42 GND
PA_2	43	44 GND
PA_1	45	46 GND
PA_0	47	48 GND
+5V	49	50 GND

CN2, CN3, CN4, CN5, CN6
CN7 (PIO-D168U only)

2.4.2 PEX-D144LS

- CON1: 100-pin SCSI II female connector (for Port0 to Port11).
- CON2: 50-pin flat-cable connector (for Port12 to Port17).

Pin Assignment	Terminal No.	Pin Assignment
PA_00	01	51 PA_10
PA_01	02	52 PA_11
PA_02	03	53 PA_12
PA_03	04	54 PA_13
PA_04	05	55 PA_14
PA_05	06	56 PA_15
PA_06	07	57 PA_16
PA_07	08	58 PA_17
PB_00	09	59 PB_10
PB_01	10	60 PB_11
PB_02	11	61 PB_12
PB_03	12	62 PB_13
PB_04	13	63 PB_14
PB_05	14	64 PB_15
PB_06	15	65 PB_16
PB_07	16	66 PB_17
PC_00	17	67 PC_10
PC_01	18	68 PC_11
PC_02	19	69 PC_12
PC_03	20	70 PC_13
PC_04	21	71 PC_14
PC_05	22	72 PC_15
PC_06	23	73 PC_16
PC_07	24	74 PC_17
GND	25	75 GND
PA_20	26	76 PA_30
PA_21	27	77 PA_31
PA_22	28	78 PA_32
PA_23	29	79 PA_33
PA_24	30	80 PA_34
PA_25	31	81 PA_35
PA_26	32	82 PA_36
PA_27	33	83 PA_37
PB_20	34	84 PB_30
PB_21	35	85 PB_31
PB_22	36	86 PB_32
PB_23	37	87 PB_33
PB_24	38	88 PB_34
PB_25	39	89 PB_35
PB_26	40	90 PB_36
PB_27	41	91 PB_37
PC_20	42	92 PC_30
PC_21	43	93 PC_31
PC_22	44	94 PC_32
PC_23	45	95 PC_33
PC_24	46	96 PC_34
PC_25	47	97 PC_35
PC_26	48	98 PC_36
PC_27	49	99 PC_37
+5 V	50	100 +5 V

Pin Assignment	Terminal No.	Pin Assignment
GND	01	02 +5 V
PA_40	03	04 PA_50
PA_41	05	06 PA_51
PA_42	07	08 PA_52
PA_43	09	10 PA_53
PA_44	11	12 PA_54
PA_45	13	14 PA_55
PA_46	15	16 PA_56
PA_47	17	18 PA_57
PB_40	19	20 PB_50
PB_41	21	22 PB_51
PB_42	23	24 PB_52
PB_43	25	26 PB_53
PB_44	27	28 PB_54
PB_45	29	30 PB_55
PB_46	31	32 PB_56
PB_47	33	34 PB_57
PC_40	35	36 PC_50
PC_41	37	38 PC_51
PC_42	39	40 PC_52
PC_43	41	42 PC_53
PC_44	43	44 PC_54
PC_45	45	46 PC_55
PC_46	47	48 PC_56
PC_47	49	50 PC_57

CON2

2.5 Enable I/O Operation

When the PC is first turned on, all operations involved with Digital I/O channels are disabled. Note that the Digital I/O channel of each port is enabled or disabled by the RESET\ signal, refer to [Section 6.3.1 “REST\ Control Register”](#) for more information related to this. The power-on states for all DI/DO ports are given as follows:

- DI/DO operations for each port are disabled.
- DI/DO ports are all configured as Digital Input ports.
- DO latch register outputs are all high impedance. (Refer to [Section 2.6 “DI/DO Architecture”](#))

The user has to perform some initialization before using these Digital I/O ports. The recommended steps are given below:

Step 1: Find the address-mapping for PIO/PISO cards. (Refer to [Section 6.1 “How to Find the I/O Address”](#))

Step 2: Enable all Digital I/O operations. (Refer to [Section 6.3.1 “REST\ Control Register”](#)).

Step 3: Select the controlled port. (Refer to [Section 6.3.8 “Active I/O Port Control Register”](#)).

Step 4: Send initial value to the DO latch register for the controlled port (Refer to [Section 2.6 “DI/DO Architecture”](#) and [Section 6.3.7 “Read/Write 8-bit Data Register”](#)).

Step 5: Repeat Steps 3 and 4 to initialize the other DO ports.

Step 6: Configure all Digital I/O ports to their expected DI or DO function (Refer to [Section 6.3.9 “I/O Selection Control Register”](#))

Note:

For more information on the initial procedure for Digital I/O ports, refer to the DIO demo program.

2.6 DI/DO Architecture

The digital I/O control architecture for the PIO-D144/D168 series is demonstrated in the figure below. The operation method used for the control signal is presented below.

- RESET\ is in the Low-state → all DI/DO operation is disabled
- RESET\ is in the High-state → all DI/DO operation is enabled.
- If DI/DO is configured as a DI port → DI= external input signal
- If DI/DO is configured as a DO port → DI = read back DO

If the DI/DO is configured as a DI port → sending data to a Digital input port will only change the DO latch register. The latched data will be output when the port is configured as digital output and is activated right away.

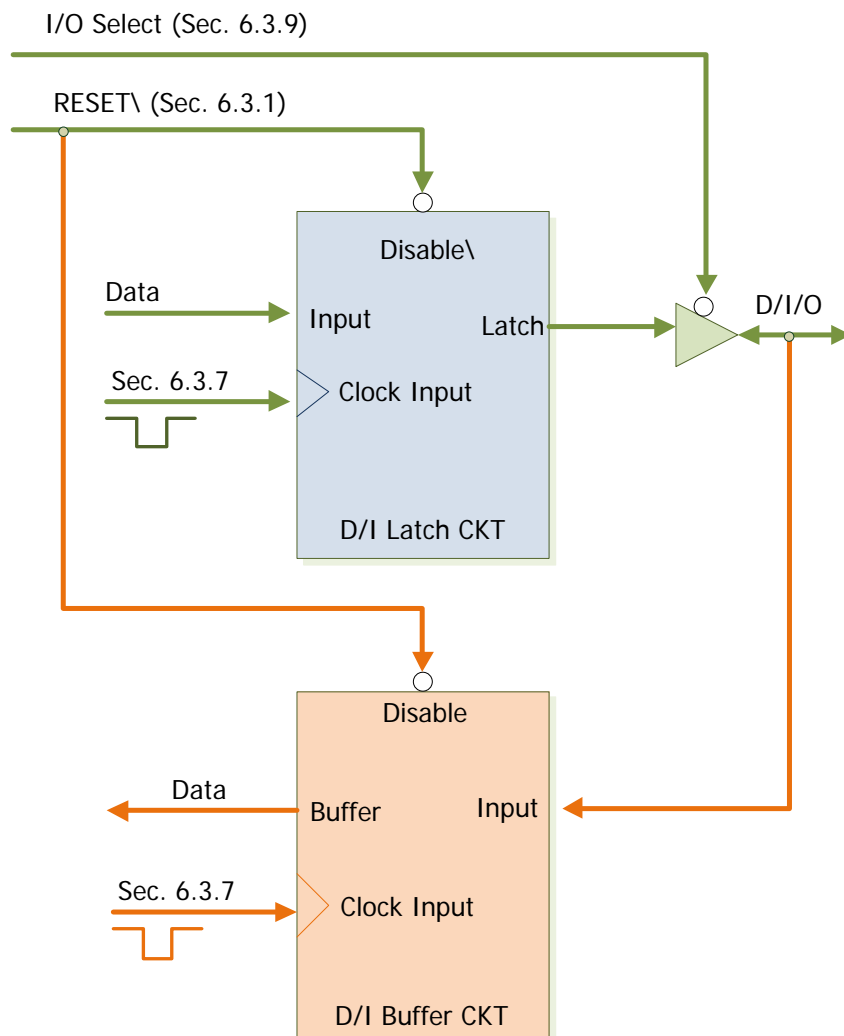

2.7 Interrupt Operation

The P2C0/P2C1/P2C2/P2C3 interrupts pins of the CN1 connector can be used as interrupt signal source. Refer to [Section 2.1 “Board Layout”](#) and [Section 2.4 “Pin Assignments”](#) for P2C0/P2C1/P2C2/P2C3 location. The interrupt of PIO-D144 and PIO-D168 series is **level-trigger** and **Active_High**. The interrupt signal can be programmable as **inverted** or **non-inverted**. The procedures for how to configure the interrupt signal source are given as follows:

1. Make sure **the initial level is high or Low from the signal source**.
2. If the initial state is High, please select the **inverted** setting for interrupt signal source ([Section 6.3.6 “Interrupt Polarity Register”](#)). If the initial state is Low, please select the **non-inverted** setting for interrupt signal source ([Section 6.3.6 “Interrupt Polarity Register”](#))
3. Enable the interrupt function ([Section 6.3.4 “INT Mask Control Register”](#))
4. If the interrupt signal is active, the interrupt service routine will be started up.

Note that DEMO3.C and DEMO4.C are demo programs for a single interrupt source and DEMO5.C is the demo program for four interrupt sources in the DOS operating system. If only one interrupt signal source is used, the interrupt service routine does not need to identify the interrupt source. (Refer to DEMO3.C and DEMO4.C). However, if there are more than one interrupt source, the interrupt service routine has to identify the active signals in the following manner: (refer to DEMO5.C)

1. Read the new status of the interrupt signal sources.
2. Compare the new status with the old status to identify the active signals.
3. If P2C0 is active, service P2C0 and non-inverter/inverted the P2C0 signal.
4. If P2C1 is active, service P2C1 and non-inverted/inverted the P2C1 signal.
5. If P2C2 is active, service P2C2 and non-inverted/inverted the P2C2 signal.
6. If P2C3 is active, service P2C3 and non-inverted/inverted the P2C3 signal.
7. Update the interrupt status.

Note

If the interrupt signal is too short, the new status may be the same as the old status. So the interrupt signal must be held active until the interrupt service routine has been executed. This hold time is different for differing operating systems. The hold time can be as short as a micro-second or as long as 1 second. In general, 20 ms is enough for all O.S.

3. Hardware Installation

Note:

It is recommended that the driver is installed before installing the hardware as the computer may need to be restarted once the driver is installed in certain operating systems, such as Windows 2000 or Windows XP, etc. Installing the driver first helps reduce the time required for installation and restarting the computer.

Follow the process described below to install your PIO-D144/D168 series card:

Step 1: Install the driver for your board on Host computer.



For detailed information about the driver installation, refer to [Chapter 4 “Software Installation”](#).

Step 2: Configure the Card ID using the DIP Switch (SW1).

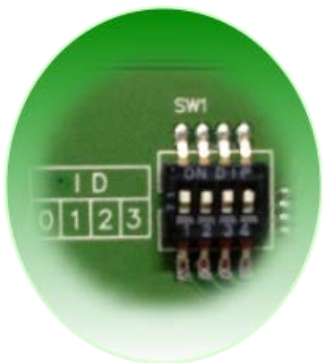

For detailed information about the card ID (SW1), refer to [Section 2.3 “Card ID Switch”](#).

Note

The Card ID function is only supported by the PIO-D144U/D144LU, PEX-D144LS and PIO-D168U.



Step 3: Shut down and switch off the power to the computer, and then disconnect the power supply.

Step 4: Remove the cover from the computer.

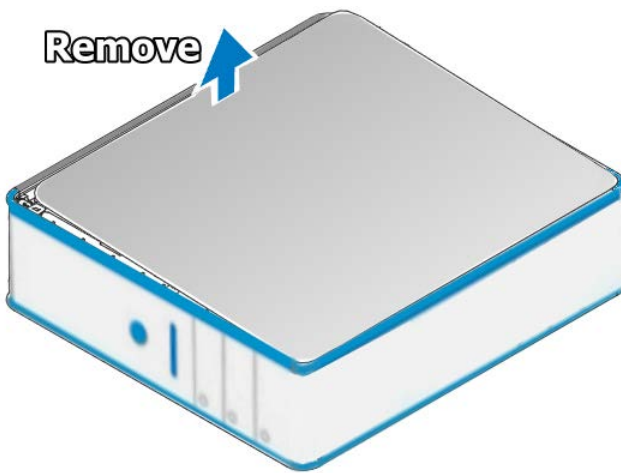

Step 5: Select a vacant PCI/PCI Express slot.

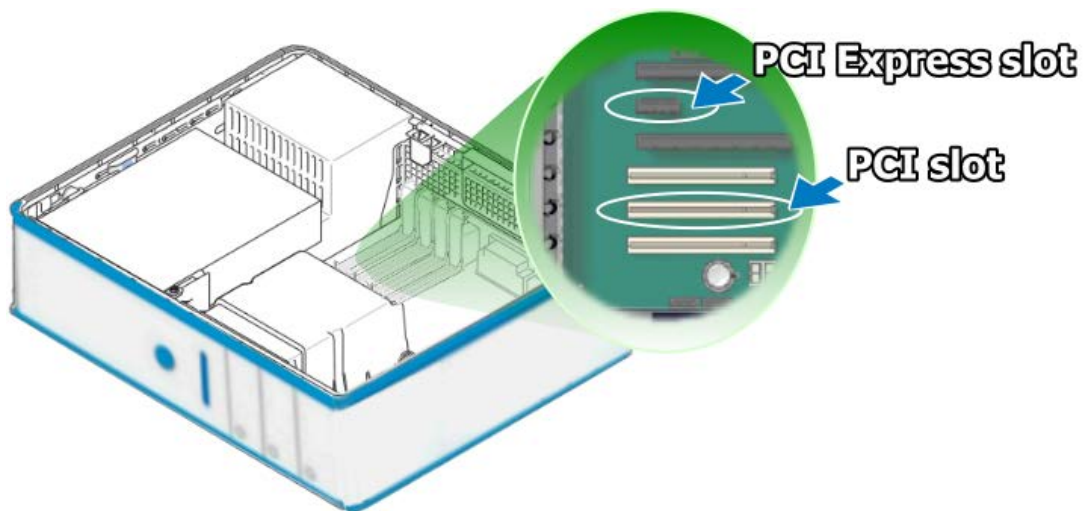

Step 6: Unscrew and remove the PCI slot cover from the computer case.

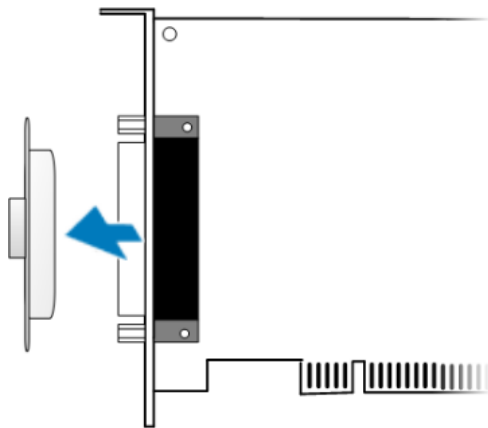
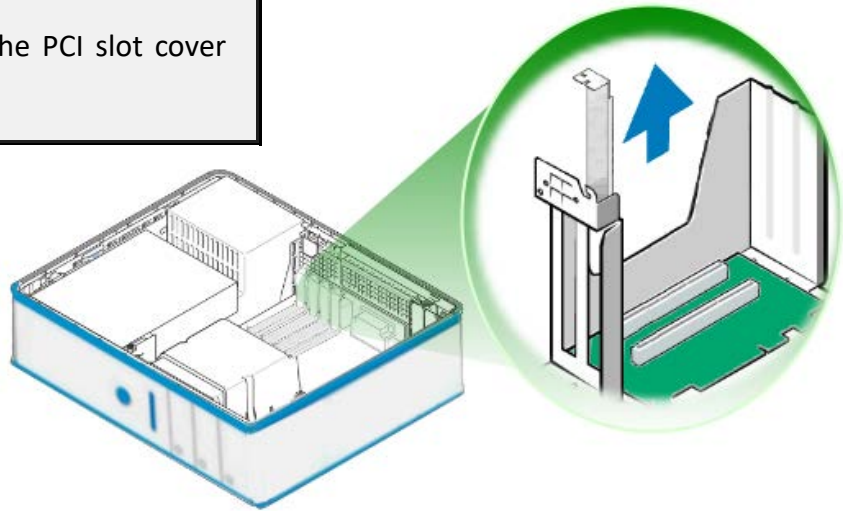

Step 7: Remove the connector cover form your board.

Step 8: Carefully insert your board into the PCI/PCI Express slot by gently pushing down on both sides of the board until it slides into the PCI connector.

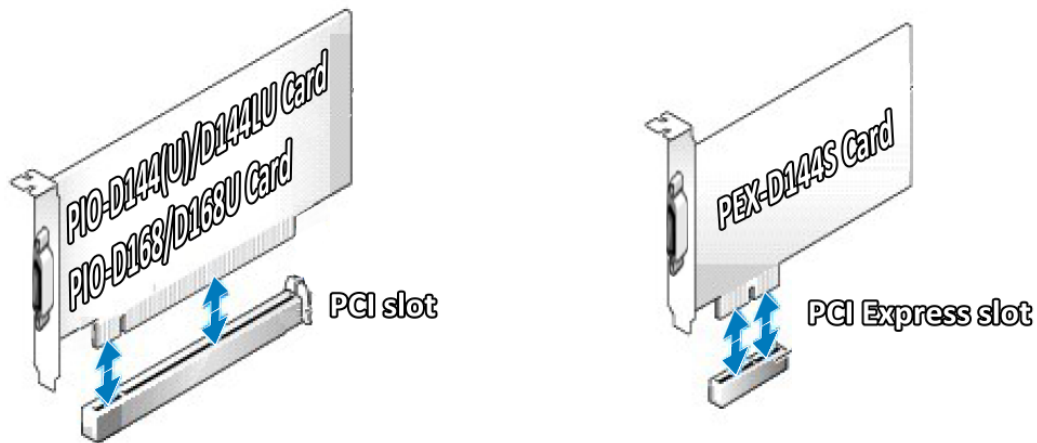

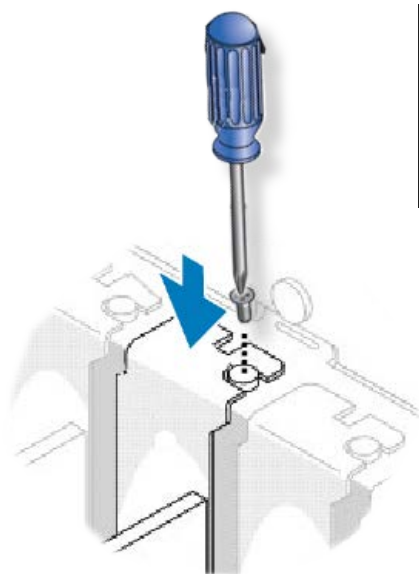

Step 9: Confirm that the board is correctly inserted in the motherboard, and then secure your board in place using the retaining screw that was removed in **Step 6**.

Step 10: Replace the covers on the computer.

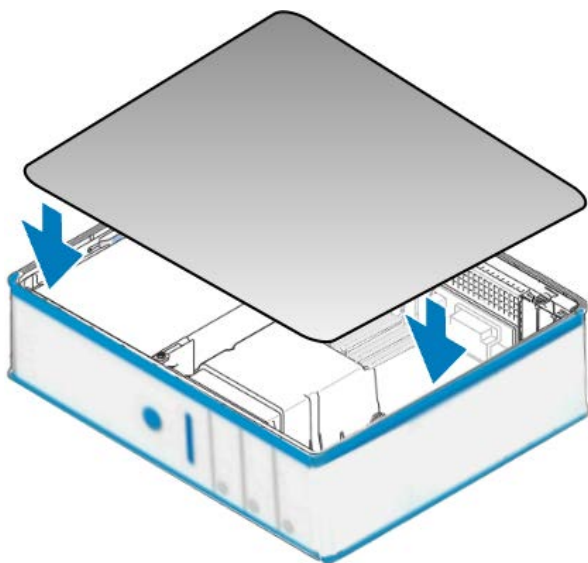

Step 11: Re-attach any cables, insert the power cord and then switch on the power to the computer.



Once the computer reboots, follow any message prompts that may be displayed to complete the Plug and Play installation procedure. Refer to [Chapter 4 “Software Installation”](#) for more information.

4. Software Installation

This chapter provides a detailed description of the process for installing the PIO-D144/D168 series driver and how to verify whether the PIO-D144/D168 series card was properly installed. PIO-D144/D168 series card can be used on DOS, Linux and 32-/64-bit XP/2003/2008/7/8/10 based systems, and the drivers are fully Plug and Play (PnP) compliant for easy installation.

4.1 Obtaining/Installing the Driver Installer Package

The driver installation package for PIO-D144/D168 series board can be found on the companion CD-ROM, or can be obtained from the ICP DAS FTP web site. Install the appropriate driver for your operating system. The location and website addresses for the installation package are indicated below.

➤ **UniDAQ Driver/SDK** (It is recommended to install this driver for new user.)

OS	Windows 2000, 32/64-bit Windows XP, 32/64-bit Windows 2003, 32/64-bit Windows Vista, 32/64-bit Windows 7, 32/64-bit Windows 2008, 32/64-bit Windows 8, 32/64-bit Windows 10
Driver Name	UniDAQ Driver/SDK (unidaq_win_setup_xxxx.exe)
CD-ROM	CD:\NAPDOS\PCI\UniDAQ\DLL\Driver\
Web Site	http://ftp.icpdas.com/pub/cd/iocard/pci/napdos/pci/unidaq/dll/driver/
Installing Procedure	<p>To install the UniDAQ driver, follow the procedure described below.</p> <p>Step 1: Double-click the UniDAQ_Win_Setupxxx.exe icon to begin the installation process.</p>

Installation Procedure

Step 2: When the “Welcome to the ICP DAS UniDAQ Driver Setup Wizard” screen is displayed, click the “**N**ext>” button to start the installation.

Step 3: On the “Information” screen, verify that the DAQ board is included in the list of supported devices, then click the “**N**ext>” button.

Step 4: On the “Select Destination Location” screen, click the “**N**ext>” button to install the software in the default folder, **C:\ICPDAS\UniDAQ**.

Step 5: On the “Select Components” screen, verify that the DAQ board is in the list of device, and then click the “**N**ext>” button to continue.

Step 6: On the “Select Additional Tasks” screen, click the “**N**ext>” button to continue.

Step 7: On the “Download Information” screen, click the “**N**ext>” button to continue.

Step 8: Once the installation has completed, click “**N**o, I will restart my computer later”, and then click the “**F**inish” button.

For more detailed information about how to install the UniDAQ driver, refer to **Section 2.2 “Install UniDAQ Driver DLL”** of the **UniDAQ Software Manual**, which can be found in the [\NAPDOS\PCI\UniDAQ\Manual](#) folder on the companion CD, or can be downloaded from: <http://ftp.icpdas.com/pub/cd/iocard/pci/napdos/pci/unidaq/manual/>

- **PIO-DIO Series Classic Driver** (Recommended to install this driver for have been used PIO-DIO series boards of regular user)

OS	Windows 95/98/ME, Windows NT, Windows 2000, 32-bit Windows XP, 32-bit Windows 2003, 32-bit Windows Vista, 32-bit Windows 7, 32-bit Windows 8, , 32-bit Windows 10
Driver Name	PIO-DIO Series Classic Driver(PIO_DIO_Win__vxxx.exe)
CD-ROM	CD:\NAPDOS\PCI\PIO-DIO\DLL_OCX\Driver\
Web Site	http://ftp.icpdas.com/pub/cd/iocard/pci/napdos/pci/pio-dio/dll_ocx/driver/
Installing Procedure	<p>Please follow the following steps to setup software:</p> <p>Step 1: Double click the PIO-DIO Series Classic Driver to setup it.</p> <p>Step 2: When the Setup Wizard screen is displayed, click the Next> button.</p> <p>Step 3: Select the folder where the drivers are to install. The default path is C:\DAQPro\PIO-DIO. But if you wish to install the drivers to a different location , click the "Browse..." button and select the relevant folder and then click the Next> button.</p> <p>Step 4: Click the Install button to continue.</p> <p>Step 5: Select the item "No, I will restart my computer later", press the Finish button.</p> <p>For detailed information about how to install the PIO-DIO Classic Driver, refer to the PIO-DIO Series Classic Driver DLL Software, which can be found in the \NAPDOS\PCI\PIO-DIO\Manual\ folder on the companion CD, or can be downloaded from: http://ftp.icpdas.com/pub/cd/iocard/pci/napdos/pci/pio-dio/manual/</p>

4.2 PnP Driver Installation

Step 1: Correctly shut down and power off your computer and disconnect the power supply, and then install your board into the computer. For detailed information about the hardware installation of PIO-D144/168 series board, refer to [Chapter 3 “Hardware Installation”](#).

Step 2: Power on the computer and complete the Plug and Play installation.

Note:

recent operating systems, such as Windows 7/8/10 will automatically detect the new hardware and install the necessary drivers etc., so Steps 3 to 5 can be skipped.

Step 3: Select “Install the software automatically [Recommended]” and click the “Next>” button.

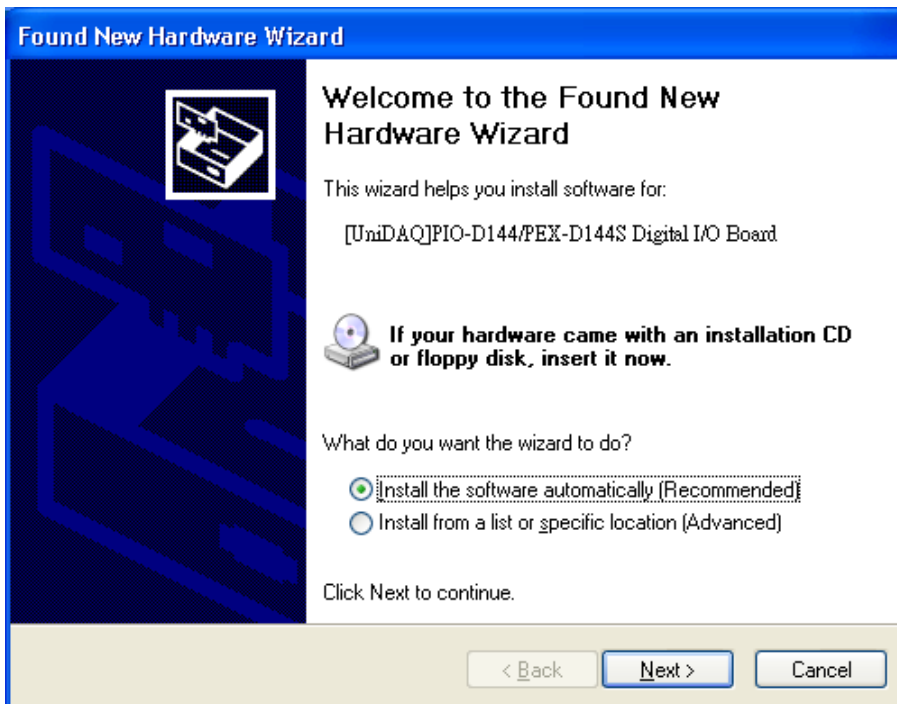

Step 4: Click the “Finish” button.

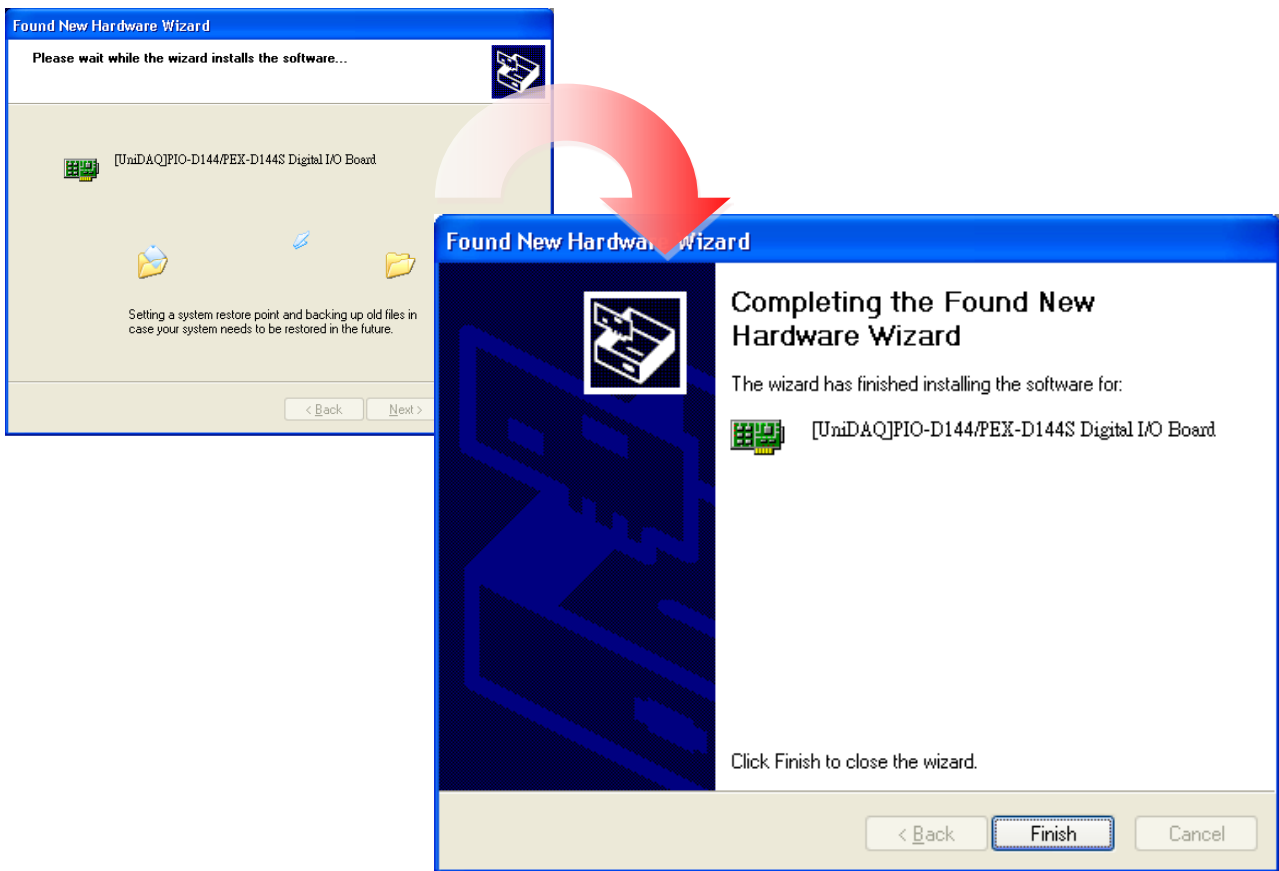

Step 5: Windows pops up “Found New Hardware” dialog box again.



4.3 Verifying the Installation

To verify that the driver was correctly installed, use the Windows **Device Manager** to view and update the device drivers installed on the computer, and to ensure that the hardware is operating correctly. The following is a description of how access the Device Manager in each of the major versions of Windows. Refer to the appropriate description for the specific operating system to verify the installation.

4.3.1 Accessing Windows Device Manager

➤ Windows 95/98/ME

Step 1: Either right-click the **“My Computer”** icon on the desktop and then click **“Properties”**, or open the **“Control Panel”** and double-click the **“System”** icon to open the System Properties dialog box.

Step 2: In the **System Properties** dialog box, click the **“Device Manager”** tab.

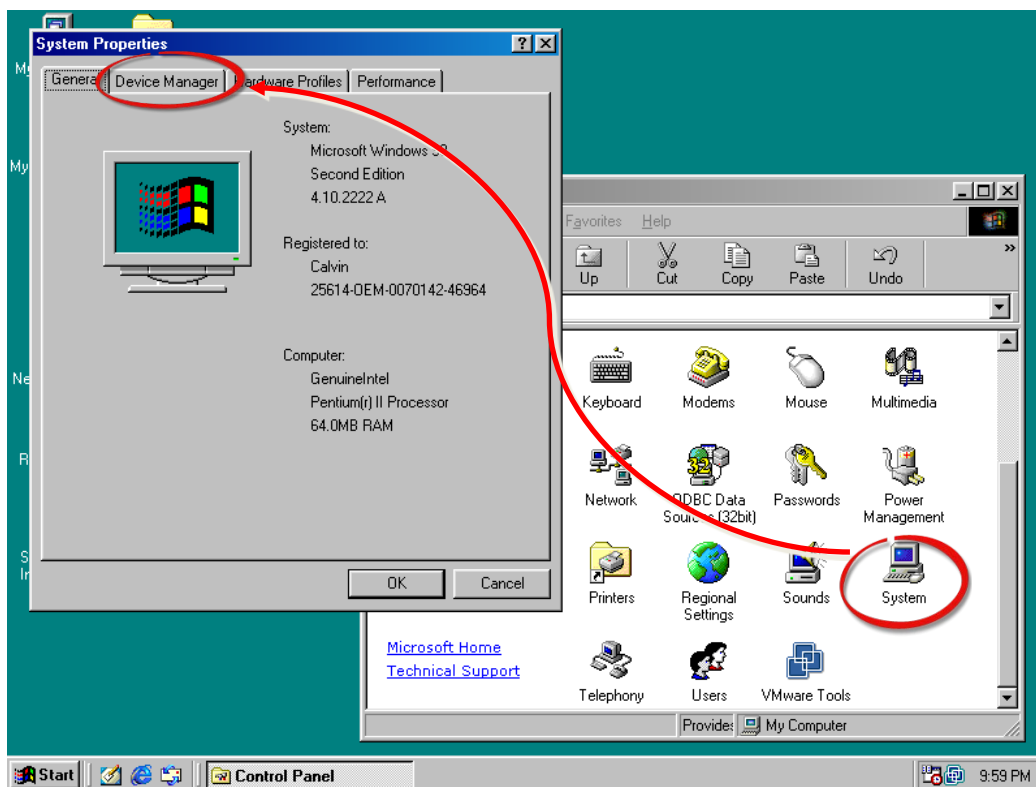

➤ **Windows 2000/XP**

Step 1: Click the “**Start**” button and then point to “**Settings**” and click “**Control Panel**”.
Double-click the “**System**” icon to open the “**System Properties**” dialog box.

Step 2: Click the “**Hardware**” tab and then click the “**Device Manager**” button.



➤ **Windows Server 2003**

Step 1: Click the “**Start**” button and point to “**Administrative Tools**”, and then click the “**Computer Management**” option.

Step 2: Expand the “**System Tools**” item in the console tree, and then click “**Device Manager**”.

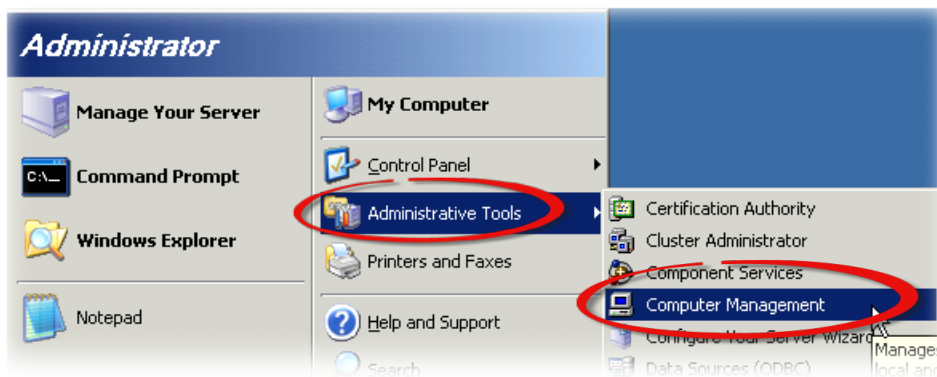

➤ **Windows 7/10**

Step 1: Click the “Start” button, and then click “Control Panel”.

Step 2: Click “System and Maintenance”, and then click “Device Manager”.

Alternatively,

Step 1: Click the “Start” button.

Step 2: In the Search field, type **Device Manager** and then press Enter.

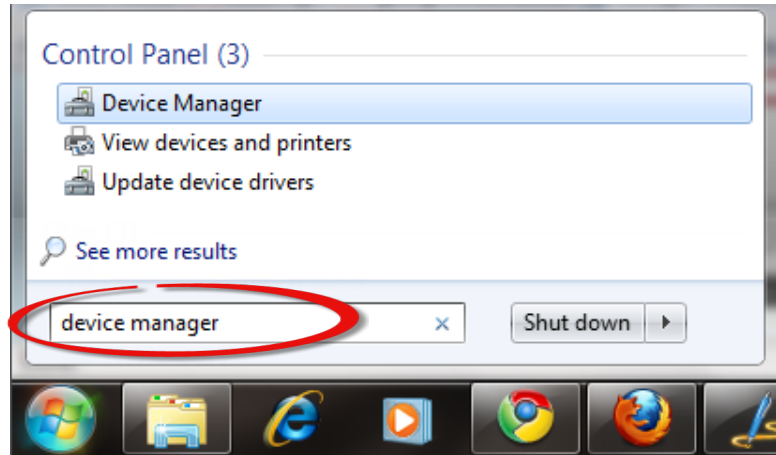

Note:

Administrator privileges are required for this operation. If you are prompted for an administrator password or confirmation, enter the password or provide confirmation by clicking the “Yes” button in the User Account Control message.

➤ **Windows 8**

Step 1: To display the **Start screen icon** from the desktop view, hover the mouse cursor over the **bottom-left corner** of screen.

Step 2: **Right-click** the Start screen icon and then click “Device Manager”.

Alternatively, press [**Windows Key**] +[**X**] to open the Start Menu, and then select Device Manager from the options list.

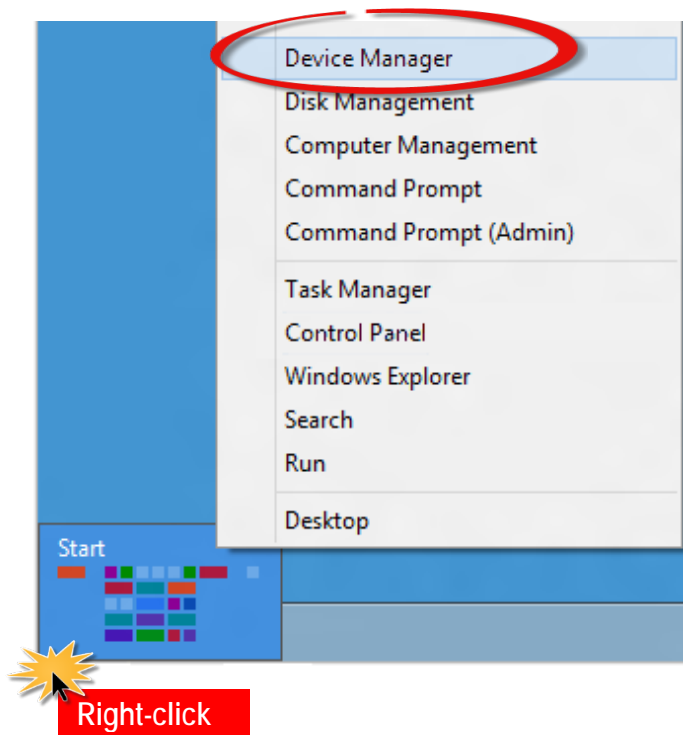

4.3.2 Check that the Installation

Check that the PIO-D144/D168 series board is correctly listed in the **Device Manager** window, as illustrated below.

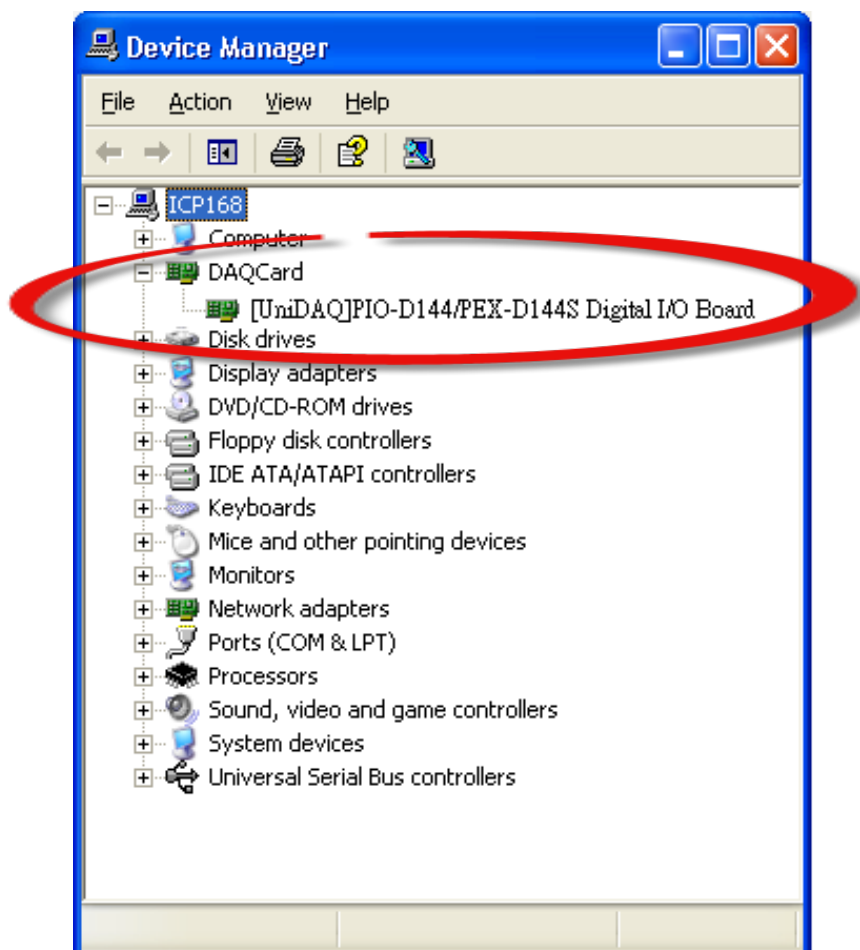

5. Board Testing

This chapter provides detailed information about the “Self-Test” process, which is used to confirm that the PIO-D144/D168 series board is operating correctly. Before beginning the “Self-Test” process, ensure that both the hardware and driver installation procedures are fully completed. For detailed information about the hardware and driver installation, refer to [Chapter 3 “Hardware Installation”](#) and [Chapter 4 “Software Installation”](#).

5.1 Self-Test Wiring

5.1.1 PIO-D144/D144U/D144LU/D168/D168U

Before beginning the “Self-Test” procedure, ensure that the following items are available:

- A CA-3710 Cable

(Optional, Website: http://www.icpdas.com/products/Accessories/cable/cable_selection.htm)

- A DN-37 Terminal Board

(Optional, Website:

http://www.icpdas.com/root/product/solutions/pc_based_io_board/daughter_boards/dn-37.html)

Step 1: Use the DN-37 (optional) to connect the CN1 on the board.

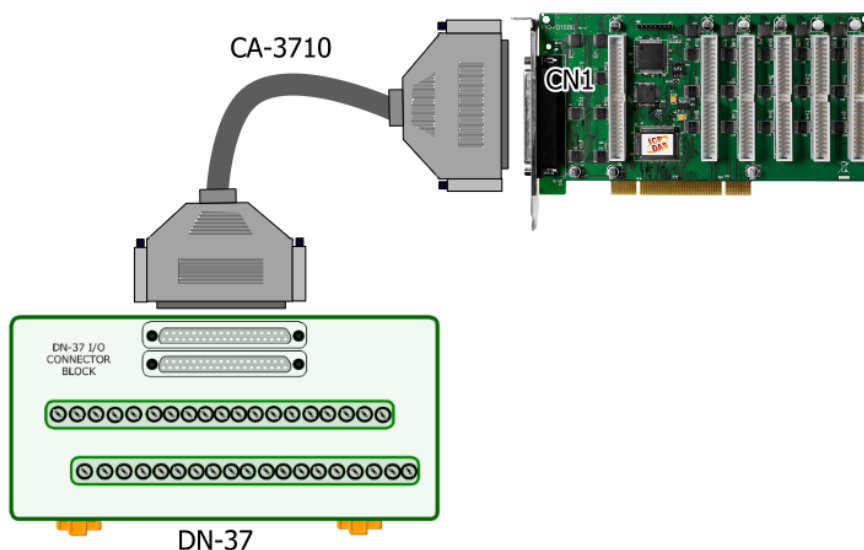

Step 2: Connect the Port0 (PA0 ~ PA7) with Port1 (PB0 ~ PB7).

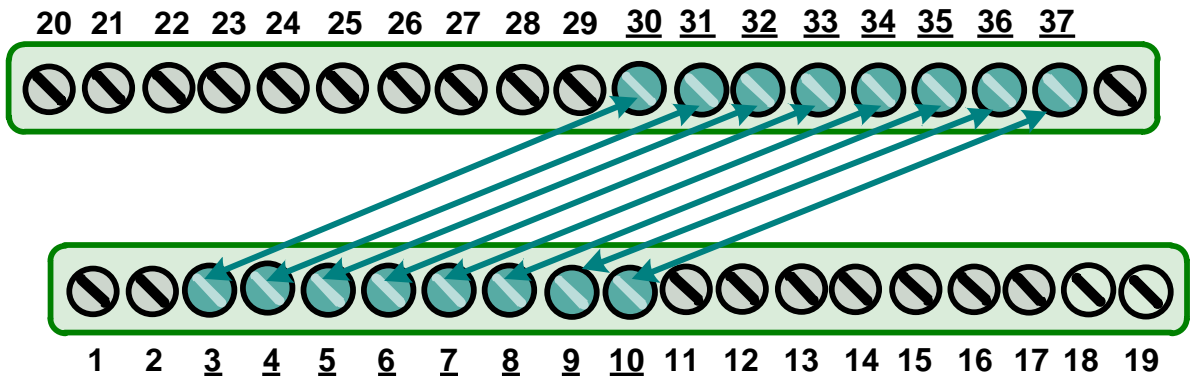

5.1.2 PEX-D144LS

Before beginning the “Self-Test” procedure, ensure that the following items are available:

A CA-SCSI100-15 Cable

(Optional, Website: http://www.icpdas.com/products/Accessories/cable/cable_selection.htm)

A DN-100 Terminal Board

(Optional, Website:

http://www.icpdas.com/root/product/solutions/pc_based_io_board/daughter_boards/dn-100.html)

Step 1: Use DN-100 wiring terminal board (optional) to connect the CON1 on the PEX-D144LS card.

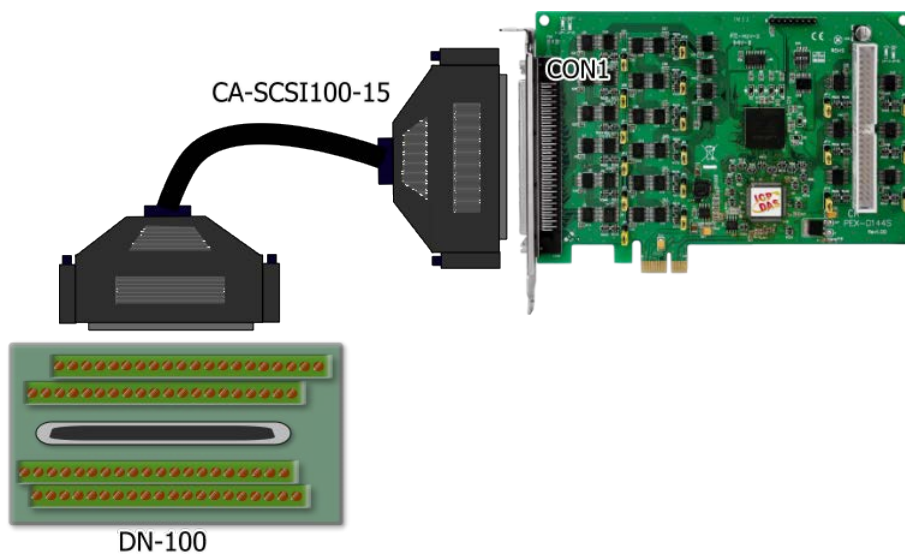

Step 2: Connect the Port0 (PA00 ~ PA07) with Port1 (PB00 ~ PB07).

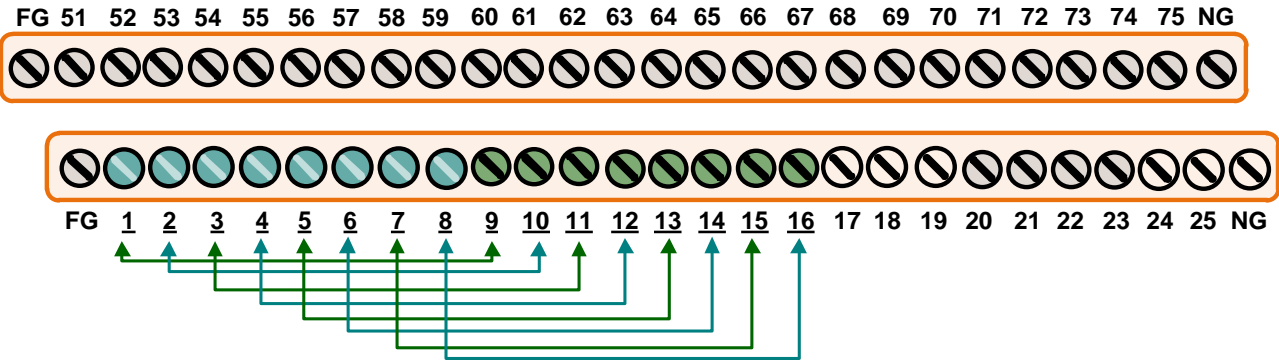

5.2 Launch the Test Program

The following example use UniDAQ driver to perform self-test. If you install the PIO-DIO series classic driver, refer to Quick Start Guide of the PIO-D144/D168 series (<http://ftp.icpdas.com/pub/cd/iocard/pci/napdos/pci/pio-dio/manual/quickstart/classic/>) to execute the self-test.

Step 1: Double-click the **UniDAQ Utility** software. The UniDAQ Utility will be placed in the **default path "C:\ICPDAS\UniDAQ\Driver"** after completing installation.

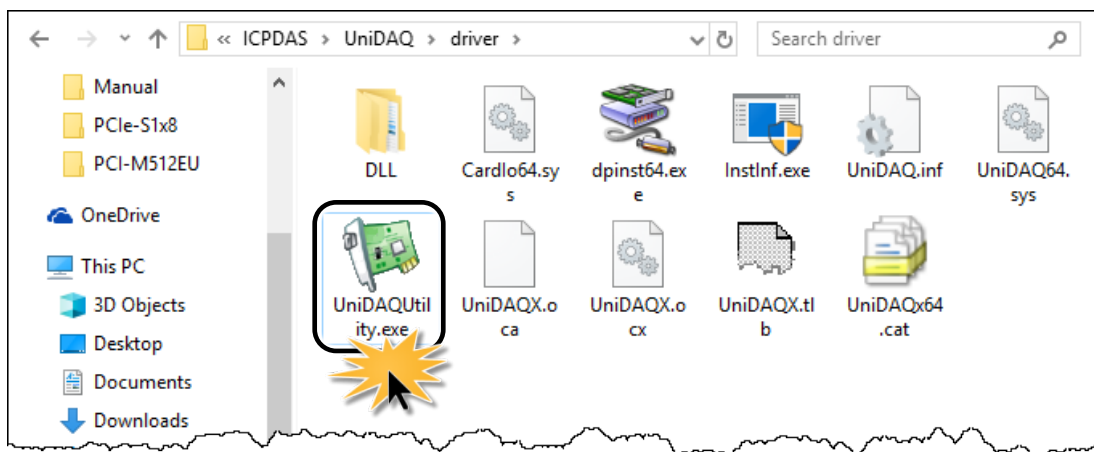

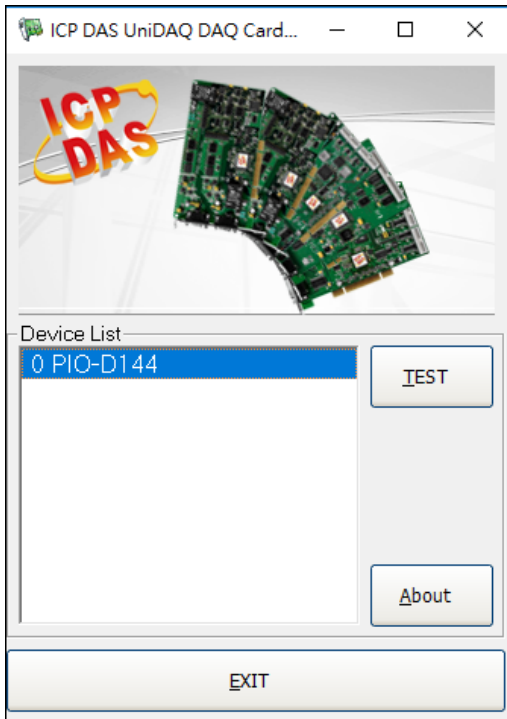

Step 2: Confirm that your board has been successfully installed in the Host system. **Note that the device number starts from 0.**

Step 3: Click the “**TEST**” button to start the test.

Notes:

The PEX-D144LS, PIO-D144LU, PIO-D144U and PIO-D168U software is fully compatible with the PIO-D144/PIO-D168 series software.

Step 4: Check the results of the **Digital Input and Digital Output** functions test.

1. Click the “**Digital Output**” tab.
2. Select “**Port 1**” from the “**Port Number**” drop-down menu.
3. Check the checkboxes for **channels 0, 2, 4 and 6**.

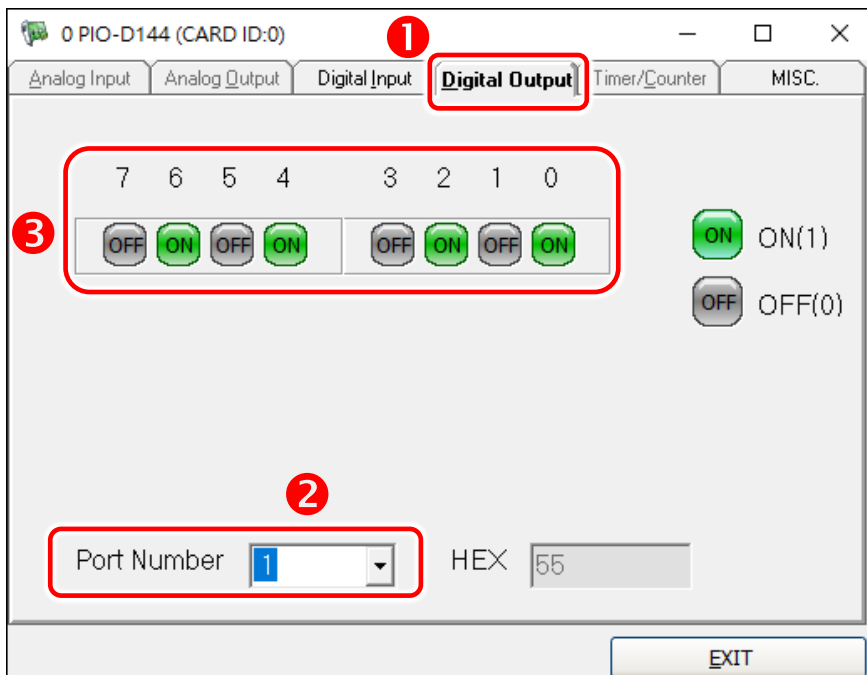

4. Click the **“Digital Input”** tab.
5. Select **“Port 0”** from the **“Port Number”** drop-down menu.
6. The DI indicators will turn **red** when the corresponding DO channels 0, 2, 4 and 6 are **ON**.

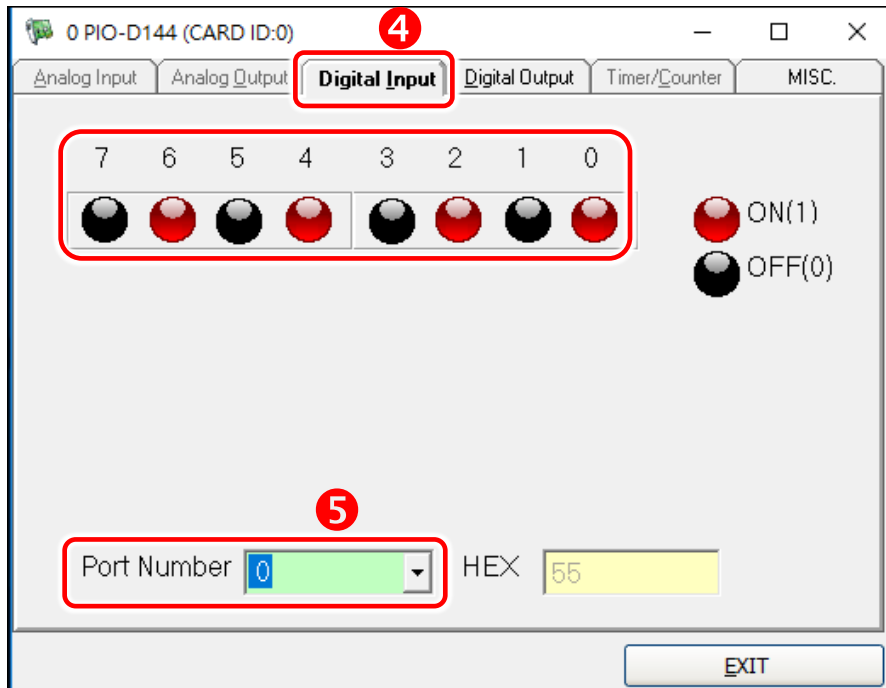

6. I/O Control Register

6.1 How to Find the I/O Address

During the power-on stage, the Plug and Play BIOS will assign an appropriate I/O address to each PIO-D144/D168 series card installed in the system. Each board includes four fixed ID numbers that are used to identify the board, and are indicated below:

Table 6-1:

	PIO-D144 (Rev 1.0 ~ 3.0)	PIO-D144/D144U/D144LU (Rev 4.0 or above)	PEX-D144LS (Rev 1.0 or above)
Vendor ID	0xE159	0xE159	0xE159
Device ID	0x0002	0x0001	0x0001
Sub-Vendor ID	0x80	0x5C80, 0x1c80	0x1c80
Sub-Device ID	0x01	0x01	0x01
Sub-Aux ID	0x10	0x00	0x00

Table 6-2:

	PIO-D168A	PIO-D168/D168U
Vendor ID	0xE159	0xE159
Device ID	0x0002	0x0001
Sub-Vendor ID	0x80	0x9880
Sub-Device ID	0x01	0x01
Sub-Aux ID	0x50	0x50

We provide all necessary functions as follows:

1. **PIO_DriverInit**(&wBoard, wSubVendor, wSubDevice, wSubAux)
2. **PIO_GetConfigAddressSpace**(wBoardNo, *wBase, *wIrq, *wSubVendor, *wSubDevice, *wSubAux, *wSlotBus, *wSlotDevice)
3. **Show_PIO_PISO**(wSubVendor, wSubDevice, wSubAux)

All functions are defined in PIODIO.H. Refer to [Section 6.3 “The I/O Address Map”](#) for more information. The important driver information is given as follows:

■ **Allocated resource information:**

- **wBase** : BASE address mapping in this PC
- **wIrq**: Allocated IRQ channel number of this board in this PC

■ **PIO/PISO identification information:**

- **wSubVendor**: subVendor ID of this board
- **wSubDevice**: subDevice ID of this board
- **wSubAux**: subAux ID of this board

■ **PC’s physical slot information:**

- **wSlotBus**: The bus number of the slot used by this board.
- **wSlotDevice**: The device number of the slot used by this board.

The PIO_PISO.EXE utility will detect and show all PIO/PISO cards installed in this PC. Refer to [“PIO_PISO.EXE Utility”](#) for more information.

➤ PIO_PISO.EXE Utility

The **PIO_PISO.EXE** utility is valid for all PIO/PISO cards. This program shows all PCI hardware ID regarding the PIO and PISO series DAQ cards. It is useful to test if the card Plug & Play successfully when the computer bootup. If the PIO or PISO series card does not shown in the screen correctly, please try to use another PCI slot and try again.

The user can execute the **PIO_PISO.EXE** to get the following information:

- List all PIO/PISO cards installed in this PC
- List all resources allocated to every PIO/PISO cards
- List the wSlotBus and wSlotDevice for specified PIO/PISO card identification. (refer to [Section 6.2 “The Assignment of I/O Address”](#) for more information about the assignment of I/O Address)

➤ For Windows OS

The **PIO_PISO.EXE** utility is located on the CD as below and is useful for all PIO-DIO series boards. (CD:\NAPDOS\PCI\Utility\Win32\PIO_PISO\)

http://ftp.icpdas.com/pub/cd/iocard/pci/napdos/pci/utility/win32/pio_piso/

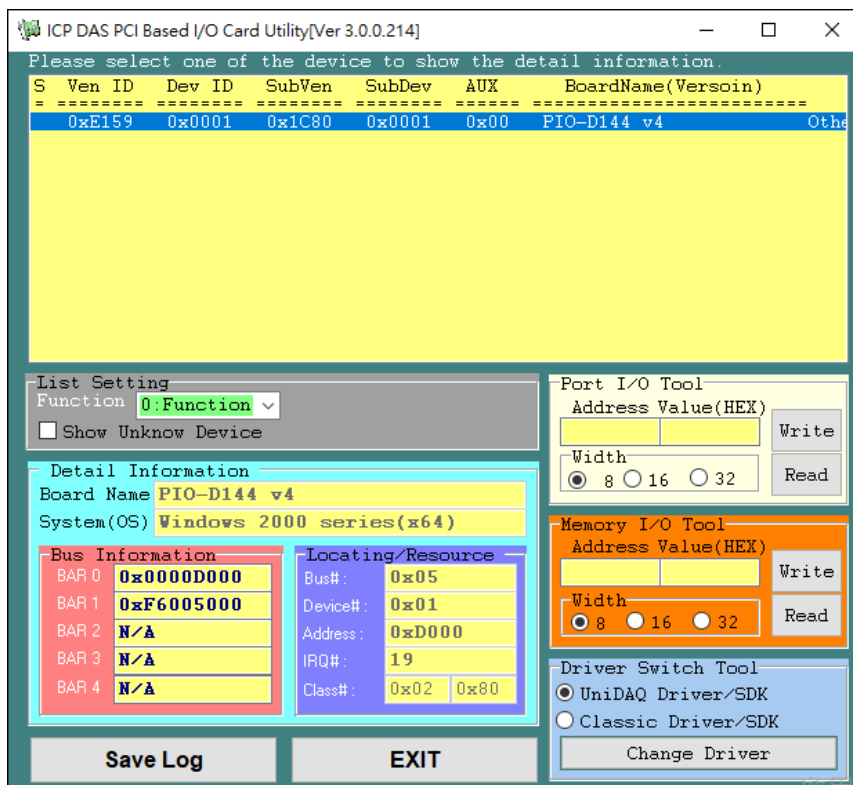

➤ For DOS

The **PIO_PISO.EXE for DOS** is contained in:

CD:\NAPDOS\PCI\Utility\DOS\

<http://ftp.icpdas.com/pub/cd/iocard/pci/napdos/pci/utility/dos/>

The PIO_PISO program source is given as follows:

```
/* ----- */
/* Find all PIO_PISO series cards in this PC system */
/* step 1 : plug all PIO_PISO cards into PC      */
/* step 2 : run PIO_PISO.EXE                    */
/* ----- */

#include "PIO.H"

WORD wBase,wIrq;
WORD wBase2,wIrq2;

int main()
{
int i,j,j1,j2,j3,j4,k,jj,dd,j11,j22,j33,j44;
WORD wBoards,wRetVal;
WORD wSubVendor,wSubDevice,wSubAux,wSlotBus,wSlotDevice;
char c;
float ok,err;

clrscr();
wRetVal=PIO_DriverInit(&wBoards,0xff,0xff,0xff); /*for PIO-PISO */
printf("\nThrer are %d PIO_PISO Cards in this PC",wBoards);
if (wBoards==0 ) exit(0);

printf("\n-----");
for(i=0; i<wBoards; i++)
{
PIO_GetConfigAddressSpace(i,&wBase,&wIrq,&wSubVendor,
&wSubDevice,&wSubAux,&wSlotBus,&wSlotDevice);

printf("\nCard %d:wBase=%x,wIrq=%x,subID=[%x,%x,%x],
SlotID=[%x,%x]",i,wBase,wIrq,wSubVendor,wSubDevice,
wSubAux,wSlotBus,wSlotDevice);

printf(" --> ");
ShowPioPiso(wSubVendor,wSubDevice,wSubAux);
}

PIO_DriverClose();
}
```

6.2 The Assignment of I/O Address

The Plug and Play BIOS will assign the proper I/O address to a PIO/PISO series card. If there is only one PIO/PISO card, the user can identify the card as card_0. If there are two PIO/PISO cards in the system, it is very difficult to identify which board is card_0. The software driver can support a maximum of 16 cards. Therefore, the user can install 16 PIO/PISO series cards onto one PC system. The methods used to find and identify card_0 and card_1 is demonstrated below.

The simplest way to identify which card is card_0 is to use wSlotBus and wSlotDevice in the following manner:

Step 1: Remove all PIO-D144/D168 series boards from the PC.

Step 2: Install one PIO-D144/D168 series onto the PC's PCI_slot1, run PIO_PISO.EXE.

Then record the "wSlotBus1" and "wSlotDevice1" information.

Step 3: Remove all PIO-D144/D168 series boards from the PC.

Step 4: Install one PIO-D144/D168 series into the PC's PCI_slot2 and run PIO_PISO.EXE.

Then record the "wSlotBus2" and "wSlotDevice2" information.

Step 5: Repeat Steps(3) and (4) for every PCI_slot and record all information from "wSlotBus" and "wSlotDevice".

The records may look similar to the table follows:

Table 6-3

PC's PCI Slot	Locating/Resource	
	wSlotBus (Bus#)	wSlotBus (Device#)
Slot_1	0	0x07
Slot_2	0	0x08
Slot_3	0	0x09
Slot_4	0	0x0A
PCI-BRIDGE		
Slot_5	1	0x0A
Slot_6	1	0x08
Slot_7	1	0x09
Slot_8	1	0x07

The above procedure will record all the “wSlotBus” and “wSlotDevice” information on a PC. These values will be mapped to this PC’s physical slot and this mapping will not be changed for any PIO/PISO cards. Therefore, this information can be used to identify the specified PIO/PISO card by following steps:

Step1: Using the “wSlotBus” and “wSlotDevice” information from Table 6-4.

Step2: Enter the board number into PIO_GetConfigAddressSpace(...) function to get the information for a specific card, especially the “wSlotBus” and “wSlotDevice” details.

Step3: Identify the specific PIO/PISO card by comparing the data of the “wSlotBus” and “wSlotDevice” from Step1 and Step2.

Note:

Normally the card installed in slot 0 is card0 and the card installed in slot1 is card1 for PIO/PISO series cards.

6.3 The I/O Address Map

The I/O address for PIO-D144/D168 series cards are automatically assigned by the main board ROM BIOS. The I/O address can also be re-assigned by the user. It is strongly recommended that users do not change the I/O address. The Plug & Play BIOS will effectively perform the assignment of proper I/O addresses to each PIO-D144/D168 series card. The I/O address for the PIO-D144/D168 series card are given in the table below, all of which are based on the base address of each card.

Table 6-4:

Address	Read	Write
wBase+0	Reserved	RESET\ Control Register
wBase+2	Reserved	Aux control register
wBase+3	Aux data register	Aux data register
wBase+5	Reserved	INT mask control register
wBase+7	Aux pin status register	Reserved
wBase+0x2a	Reserved	INT polarity control register
wBase+0xc0	Read DO Readback	Write 8-bit data to the DO port
	Read 8-bit data from the DI port	
wBase+0xc4	Reserved	Select the active I/O port
wBase+0xc8	Reserved	I/O Port 0-5 direction control
wBase+0xcc	Reserved	I/O Port 6-11 direction control
wBase+0xd0	Reserved	I/O Port 12-17 direction control
wBase+0xd4	Reserved	I/O Port 18-20 direction control (for PIO-D168 Series only)
wBase+0xf0	Read Card ID	Reserved

Note:

Refer to [Section 6.1 "How to Find the I/O Address"](#) for more information about wBase.

6.3.1 RESET\ Control Register

(Write): wBase+0

Bit 7	Bit 6	Bit 5	Bit 4	Bit 3	Bit 2	Bit 1	Bit 0
Reserved	Reserved	Reserved	Reserved	Reserved	Reserved	Reserved	RESET\

When the PC's power is first turned on, RESET\ signal is in a Low-state. **This will disable all DI/O operations.** The user has to set the RESET\ signal to a High-state before any DI/O command applications are initiated.

For example:

```

outputb (wBase,1);      /* RESET\=High → all D/I/O are enable now */
outputb (wBase,0);     /* RESET\=Low → all D/I/O are disable now */
    
```

6.3.2 AUX Control Register

(Write): wBase+2

Bit 7	Bit 6	Bit 5	Bit 4	Bit 3	Bit 2	Bit 1	Bit 0
Aux7	Aux6	Aux5	Aux4	Aux3	Aux2	Aux1	Aux0

Aux?=0 → this Aux is used as a D/I

Aux?=1 → this Aux is used as a D/O

When the PC is first turned on, all Aux signals are in a Low-state. All Aux are designed as DI for all PIO/PISO series cards.

6.3.3 Aux Data Register

(Read/Write): wBase+3

Bit 7	Bit 6	Bit 5	Bit 4	Bit 3	Bit 2	Bit 1	Bit 0
Aux7	Aux6	Aux5	Aux4	Aux3	Aux2	Aux1	Aux0

When the Aux is used for D/O, the output state is controlled by this register. This register is designed for feature extension. Therefore, do not use this register.

6.3.4 INT Mask Control Register

(Write): wBase+5

Bit 7	Bit 6	Bit 5	Bit 4	Bit 3	Bit 2	Bit 1	Bit 0
0	0	0	0	EN3	EN2	EN1	EN0

EN0=0 → Disable P2C0 of CN1 as an interrupt signal (Default).

EN0=1 → Enable P2C0 of CN1 as an interrupt signal

For example:

```

outputb(wBase+5,0);      /*Disable interrupt */
outputb(wBase+5,1);      /* Enable interrupt P2C0 */
outputb(wBase+5,0x0f);   /* Enable interrupt P2C0, P2C1,P2C2,P2C3 */
    
```

6.3.5 Aux Status Register

(Read): wBase+7

Bit 7	Bit 6	Bit 5	Bit 4	Bit 3	Bit 2	Bit 1	Bit 0
Aux7	Aux6	Aux5	Aux4	Aux3	Aux2	Aux1	Aux0

Aux0=P2C0, Aux1=P2C1, Aux2=P2C2, Aux3=P2C3, Aux7~4=Aux-ID. Refer to DEMO5.C for more information. The Aux 0~3 are used as interrupt source. The interrupt service routine has to read this register to identify the interrupt source. Refer to [Section 2.7 “Interrupt Operation”](#) for more information.

6.3.6 Interrupt Polarity Register

(Write): wBase+0x2A

Bit 7	Bit 6	Bit 5	Bit 4	Bit 3	Bit 2	Bit 1	Bit 0
0	0	0	0	INV3	INV2	INV1	INV0

This register provides a function to control invert or non-invert for the interrupt signal source. A detailed application example is given below.

INV0=1 → select the non-inverted signal from P2C0

INV0=0 → select the inverted signal from P2C0

For example:

```

outputb(wBase+0x2a,0x0f);    /* select the non-inverted input P2C0/1/2/3 */
outputb(wBase+0x2a,0x00);    /* select the inverted input of P2C0/1/2/3 */
outputb(wBase+0x2a,1);      /* select the non-inverted input of P2C0 */
                             /* select the inverted input P2C1/2/3 */

outputb(wBase+0x2a,3);      /* select the non-inverted input of P2C0/1 */
                             /* select the inverted input P2C2/3 */
    
```

Refer to [Section 2.7 “Interrupt Operation”](#) and DEMO5.C (DOS) for more information.

6.3.7 Read/Write 8-bit Data Register

(Read/Write): wBase+0xc0

Bit 7	Bit 6	Bit 5	Bit 4	Bit 3	Bit 2	Bit 1	Bit 0
D7	D6	D5	D4	D3	D2	D1	D0

The PIO-D144/D168 series contains 18/21 8-bit I/O ports, and each I/O port can be configured as either DI or a DO port. The user can send/receive digital data to/from this register for digital input or output. Note that all ports are set as DI ports when the PC is first powered-on.

For example:

```

outportb(wBase+0xc0,Val);      /* write to DO Port0 */
Val=inportb(wBase+0xc0);      /* read from DI Port0 or read a DO Readback */
    
```

Note

Ensure that the I/O port configuration is set to either DI or DO before attempting to read/write from the to data register. (Refer to [Section 6.3.9 "I/O Selection Control Register"](#))

6.3.8 Active I/O Port Control Register

(Read/Write): wBase+0xc4

Bit 7	Bit 6	Bit 5	Bit 4	Bit 3	Bit 2	Bit 1	Bit 0
D7	D6	D5	D4	D3	D2	D1	D0

The PIO-D144/D168 series contains 18/21 8-bit I/O ports, but only one I/O port can be activated at a time. The following example is a demonstration of how to activate the port of the PIO series card.

For example:

```

outportb(wBase+0xc4, 0);      /* I/O port0 is now active */
outportb(wBase+0xc4, 1);      /* I/O port1 is now active */
outportb(wBase+0xc4, 17);     /* I/O port17 is now active */
outportb(wBase+0xc4, 20);     /* I/O port20 is now active */
    
```

6.3.9 I/O Selection Control Register

(Write): wBase+0xc8

Bit 7	Bit 6	Bit 5	Bit 4	Bit 3	Bit 2	Bit 1	Bit 0
0	0	Port5	Port4	Port3	Port2	Port1	Port0

(Write): wBase+0xcc

Bit 7	Bit 6	Bit 5	Bit 4	Bit 3	Bit 2	Bit 1	Bit 0
0	0	Port11	Port10	Port9	Port8	Port7	Port6

(Write): wBase+0xd0

Bit 7	Bit 6	Bit 5	Bit 4	Bit 3	Bit 2	Bit 1	Bit 0
0	0	Port17	Port16	Port15	Port14	Port13	Port12

(Write): wBase+0xd4

Bit 7	Bit 6	Bit 5	Bit 4	Bit 3	Bit 2	Bit 1	Bit 0
0	0	0	0	0	Port20	Port19	Port18

Port?=1→ This port is used as a DI port

Port?=0→ This port is used as a DO port

These registers provide the function for configuring the digital input/output ports of the PIO/PISO series cards. Each I/O port can be programmed as a DI or a DO port. Note that all ports are set as DI ports when the PC is first powered-on. For detailed information about the I/O ports location, please refer to [Section 2.2 “I/O Port Location”](#).

For example:

```

outputb(wBase+0xc8,0);      /* Port0 to Port5 are all DO ports */
outputb(wBase+0xcc,0x3f);   /* Port6 to Port11 are all DI ports */
outputb(wBase+0xd0,0x38);   /* Port12 to Port14 are all DO ports */
                             /* Port15 to Port17 are all DI ports */
    
```

6.3.10 Card ID Register

(Read): wBase+0xf0

Bit 7	Bit 6	Bit 5	Bit 4	Bit 3	Bit 2	Bit 1	Bit 0
0	0	0	0	ID3	ID2	ID1	ID0

For example:

```
wCardID = inportb(wBase+0xf0);          /* read Card ID */
```

Note: The Card ID function is only supported by the PIO-D144U/D144LU, PEX-D144 and PIO-D168U.

7. Demo Programs

7.1 Demo Program for Windows

All demo programs will not work properly if the DLL driver has not been installed correctly. During the DLL driver installation process, the install-shields will register the correct kernel driver to the operation system and copy the DLL driver and demo programs to the correct position based on the driver software package you have selected (Win98/Me/NT/2K and 32-/64-bit winXP/2003/Vista/7/8). Once driver installation is complete, the related demo programs and development library and declaration header files for different development environments will be presented as follows.

➤ Demo Program for PIO-DIO Series Classic Driver

The demo program is contained in:



CD:\NAPDOS\PCI\PIO-DIO\DLL_OCX\Demo\



http://ftp.icpdas.com/pub/cd/iocard/pci/napdos/pci/pio-dio/dll_ocx/demo/

⊕ BCB4 → for Borland C++ Builder 4
PIODIO.H → Header files
PIODIO.LIB → Linkage library for BCB only

⊕ Delphi4 → for Delphi 4
PIODIO.PAS → Declaration files

⊕ VC6 → for Visual C++ 6
PIODIO.H → Header files
PIODIO.LIB → Linkage library for VC only

⊕ VB6 → for Visual Basic 6
PIODIO.BAS → Declaration files

⊕ VB.NET2005 → for VB.NET2005
PIODIO.vb → Visual Basic Source files

⊕ CSharp2005 → for C#.NET2005
PIODIO.cs → Visual C# Source files

For detailed information about the DLL function of the PIO-D144/D168 series, please refer to [PIO-DIO DLL Software Manual \(CD:\NAPDOS\PCI\PIO-DIO\Manual\)](#)

➤ Demo Program for UniDAQ SDK Driver

The demo program is contained in:



CD:\NAPDOS\PCI\UniDAQ\DLL\Demo\



<http://ftp.icpdas.com/pub/cd/iocard/pci/napdos/pci/unidaq/dll/demo/>

⊕ BCB6 → for Borland C++ Builder 6
UniDAQ.H → Header files
UniDAQ.LIB → Linkage library for BCB only

⊕ Delphi6 → for Delphi 6
UniDAQ.PAS → Declaration files

⊕ VB6 → for Visual Basic 6
UniDAQ.BAS → Declaration files

⊕ CSharp2005 → for C#.NET2005
UniDAQ.cs → Visual C# Source files

⊕ VC6 → for Visual C++ 6
UniDAQ.H → Header files
UniDAQ.LIB → Linkage library for VC only

⊕ VB.NET2005 → for VB.NET2005
UniDAQ.vb → Visual Basic Source files

⊕ VC.NET2005 → for VC.NET2005 (32-bit)
UniDAQ.H → Header files
UniDAQ.LIB → Linkage library for VC only

⊕ VC.NET2005 → for VC.NET2005 (64-bit)
UniDAQ.H → Header files
UniDAQ.LIB → Linkage library for VC only

For detailed information about the DLL function and demo program of the UniDAQ, please refer to UniDAQ DLL Software Manual (CD:\NAPDOS\PCI\UniDAQ\Manual)

7.2 Demo Program for DOS

The demo program is contained in:



CD:\NAPDOS\PCI\PIO-DIO\DOS\d144\
CD:\NAPDOS\PCI\PIO-DIO\DOS\d168\



<http://ftp.icpdas.com/pub/cd/iocard/pci/napdos/pci/pio-dio/dos/d144/>
<http://ftp.icpdas.com/pub/cd/iocard/pci/napdos/pci/pio-dio/dos/d168/>

⊕ \TC*. * → for Turbo C 2.xx or above

⊕ \TC\LIB*. * → for TC Library
⊕ \TC\DEMO*. * → for TC demo program
⊕ \TC\DIAG*. * → for TC diagnostic program

⊕ \TC\LIB\PIO.H → TC Declaration File
⊕ \TC\LIB\TCPIO_L.LIB → TC Large Model Library File
⊕ \TC\LIB\TCPIO_H.LIB → TC Huge Model Library File

For detailed information about the DLL function of the DOS, please refer to PIO-DIO DLL
Software Manual (CD:\NAPDOS\PCI\PIO-DIO\Manual)

Appendix: Daughter Board

A1. DB-37, DN-37, DN-50 and DN-100

- **DB-37:** The DB-37 is a general purpose daughter board for D-sub 37 pins. designed for easy wire connection via pin-to-pin. Use a 37-pin cable (e.g. CA-3710, etc.) to connect DB-37 to CON1 of the PIO-D144/D144U/D144LU and PIO-D168/D168U.

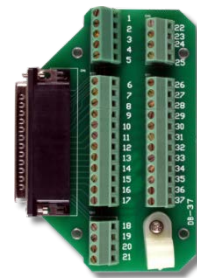

It is
DB-37

- **DN-37 and DN-50:** The DN-37 is a general purpose daughter board for DB-37 pins with DIN-Rail Mountings. The DN-50 is designed for 50-pin flat-cable headers with DIN-Rail mountings. They are also designed for easy wire connection via pin-to-pin.



DN-50

Use a 37-pin cable (e.g. CA-3710, etc.) to connect to CON1 of the PIO-D144/D144U/D144LU and PIO-D168/D168U by DN-37, and then use a 50-pin cable (e.g. CA-5002, etc.) to connect to CN1/CN2/CN3 by DN-50.

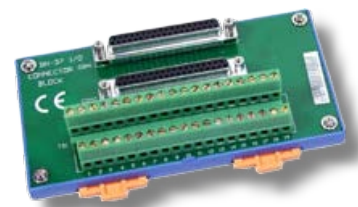

DN-37

- **DN-100:** The DN-100 is a general purpose daughter board for SCSI II 100 pins. It is designed for easy wire connection via pin-to-pin. Use a 100-pin SCSI II cable (e.g. CA-SCSI100-15, etc.) to connect DN-100 to CON1 of the PEX-D144LS.

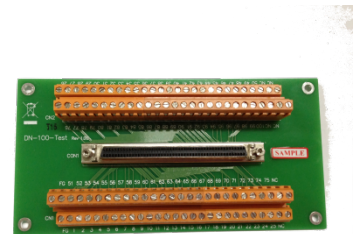

DN-100

A2. DB-8125

The DB-8125 is a general purpose screw terminal board. It is designed for easy wire connection. The DB-8125 consists of one DB-37 and two 20-pin flat-cable headers.

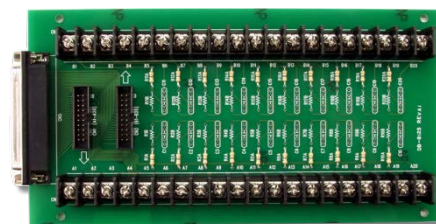

DB-8125

A3. ADP-37/PCI and ADP-50/PCI

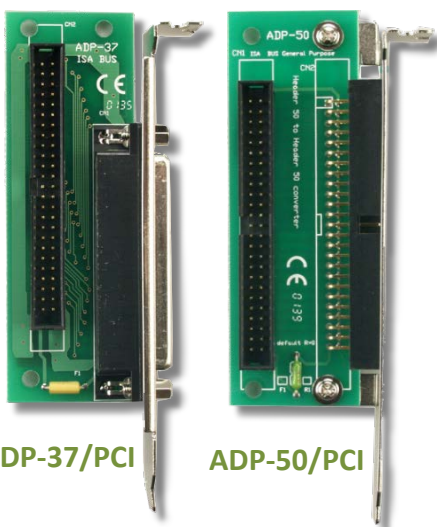

ADP-37/PCI

ADP-50/PCI

The ADP-37/PCI and ADP-50/PCI are extenders for the 50-pin header. The one side of the ADP-37/PCI or the ADP-50/PCI can be connected to a 50-pin header. Note: that ADP-37/PCI is 50-pin header to DB-37 extender and ADP-50/PCI is 50-pin header to 50-pin header extender.

The other side can be mounted onto the PC chassis as is depicted by the following:

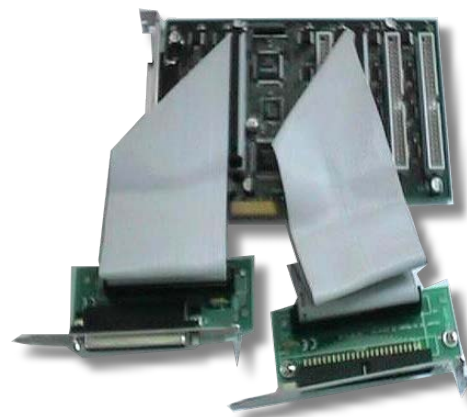

A4. DB-24P and DB-24PD Isolated Input Board

The DB-24P is a 24-channel isolated digital input daughter board. The optically isolated inputs of the DB-24P consist of a bi-directional optocoupler with a resistor for current sensing. You can use the DB-24P to sense DC signals from TTL levels up to 24 V or use the DB-24P

to sense a wide range of AC signals. You can also use this board to isolate the computer from large common-mode voltage, ground loops and transient voltage spikes that often occur in industrial environments, as shown in Figure A4-1. Table A4-1 is the comparison of DB-24P and DB-24PD.

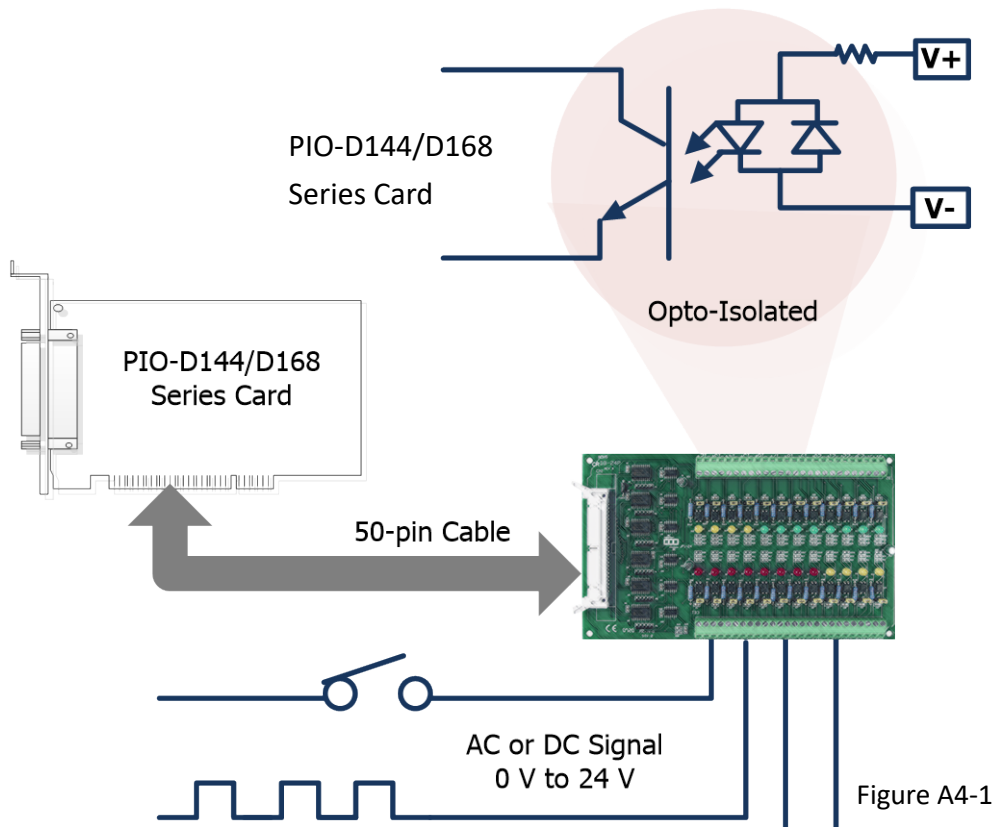
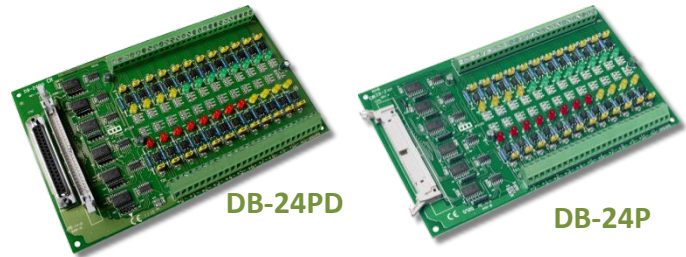

Figure A4-1

Table A4-1:

	DB-24P	DB-24PD
50-pin Flat-Cable Header	Yes	Yes
D-sub 37-pin Header	No	Yes
Other Specifications	Same	

A5. DB-24R and DB-24RD Relay Board

The DB-24R, 24-channel relay output board, consists of 24 form-C relays for efficiently controlling the switch with the use of an appropriately loaded program. The relays are energized by applying a 12 V/24 V voltage signal to the appropriate relay channel on the 50-pin flat-cable connector. There are 24 enunciator LEDs for each relay channel and the LED light will go on when their associated relay has been activated. The control scheme is illustrated below.

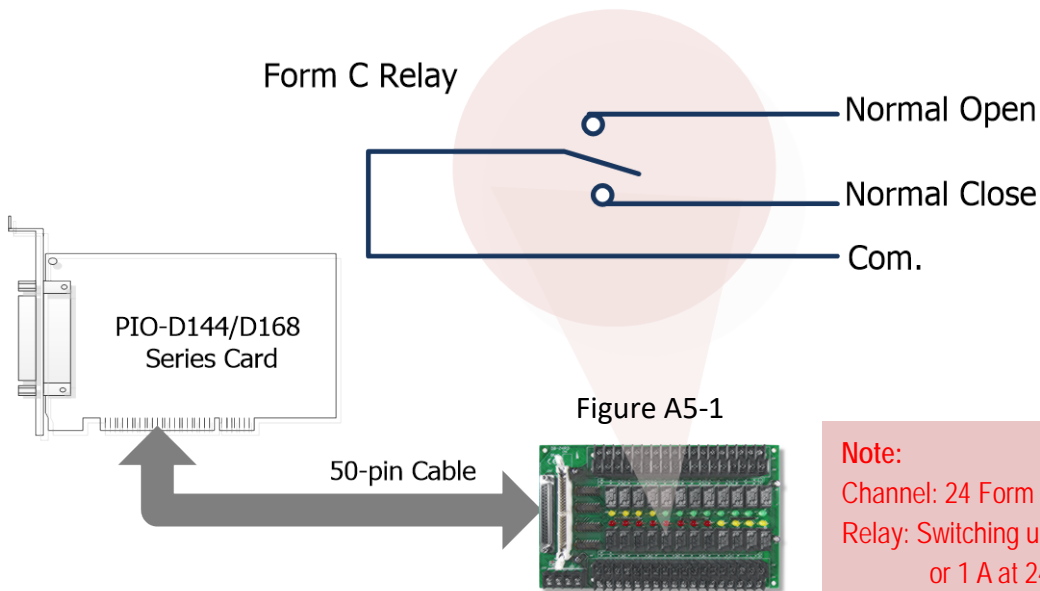
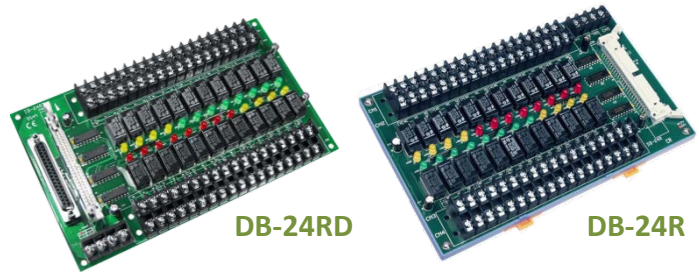

Table A5-1:

	DB-24R	DB24RD
50-pin Flat-Cable Header	Yes	Yes
D-sub 37-pin Header	No	Yes
Other Specifications	Same	

Table A5-2:

DB-24R, DB-24RD	24 * Relay (120 V, 0.5 A)
DB-24PR, DB-24PRD	24 * Power Relay (250 V, 5 A)
DB-24POR	24 * PhotoMOS Relay (350 V, 0.1 A)
DB-24SSR	24 * SSR (250 V _{AC} , 4 A)
DB-24C	24 * Open Collector (30 V, 100 mA)
DB-16P8R	16 * Relay (120 V, 0.5 A) + 8 * Isolated Input

A6. DB-24PR, DB-24POR and DB-24C

The DB-24PR, 24-channel power relay output board, consists of 8 form-C and 16 form-A electromechanical relays for efficiently

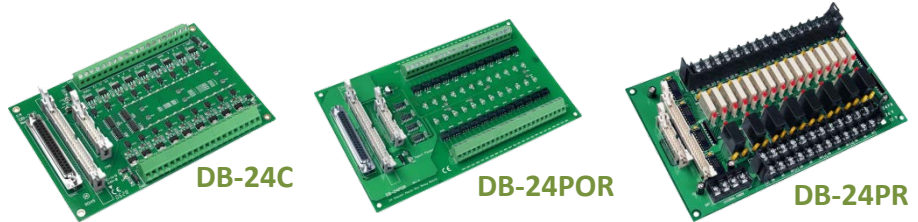

controlling the switch with the use of an appropriately loaded program. The contact of each relay can allow 5 A current load at 250 V_{AC}/30 V_{DC}. The relay is energized by applying a 5 voltage signal to the associate relay channel on the 20-pin flat-cable connector (just used 16 relays) or 50-pin flat-cable connector (OPTO-22 compatible, for DIO-24 series). 24 enunciator LEDs for indicating the status of for each relay and the corresponding LED light will go on when their associated relay has been activated. To avoid overloading your PC's power supply, this board needs a +12 V_{DC} or +24V_{DC} external power supply, as shown in Figure A6-1.

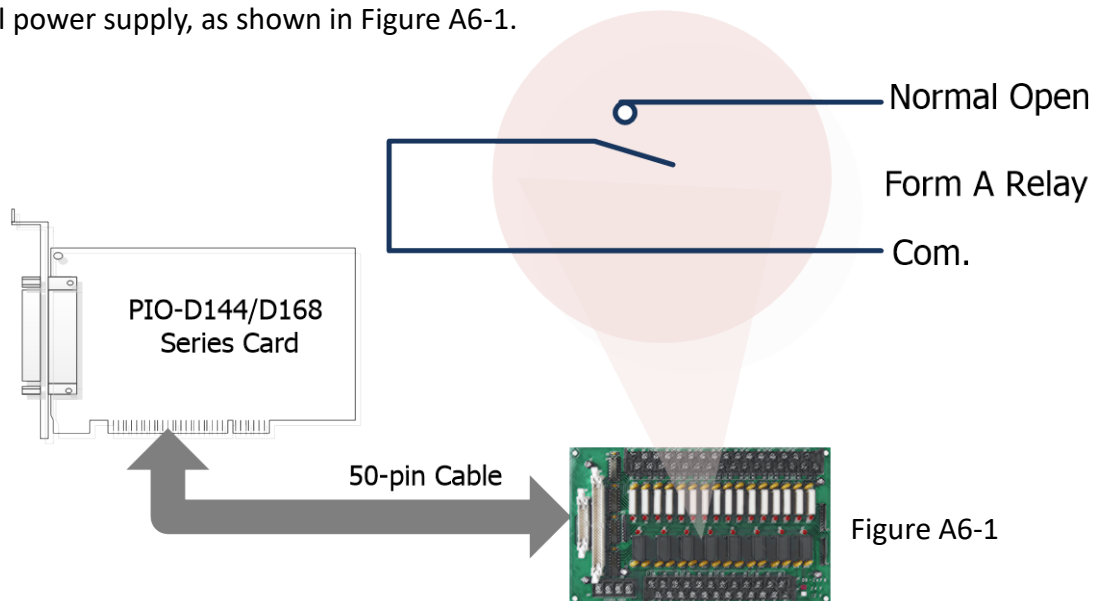

Figure A6-1

Table A6-1:

DB-24PR	24 * Power Relay, 5A/250 V
DB-24POR	24 * PhotoMOS Relay, 0.1 A/350 V _{AC}
DB-24C	24 * Open Collector, 100 mA per channel, 30 V max.

Notes:

1. 50-Pin connector (OPTO-22 compatible) for DIO-24/48/144, PIO-D144/D96/D56/D48/D24/D168.
2. 20-Pin connector for 16 channel digital output (A-82X, A-62X, DIO-64, ISO-DA16/DA8).
3. Channel: 16 Form A Relay, 8 Form C Relay.
4. Relay: switching up to 5 A at 110 V_{AC}/5 A at 30 V_{DC}.

A7. Daughter Boards Comparison Table

Table A7-1 is the comparison table for the daughter application of PIO/PISO series cards.

Table A7-1:

I/O Card	-	PIO-D144 PIO-D144U PIO-D144LU PEX-D144LS PIO-D168 PIO-D168U	PIO-D144 PIO-D144U PIO-D144LU PIO-D168 PIO-D168U	PEX-D144LS
Cable/ Daughter Boards	20-Pin Flat-Cable	50-Pin Flat-Cable	37-Pin D-sub	100-Pin SCSI II
DB-37	NO	NO	Yes	NO
DN-37	NO	NO	Yes	NO
ADP-37/PCI	NO	Yes	Yes	NO
ADP-50/PCI	NO	Yes	NO	NO
DB-24P	NO	Yes	NO	NO
DB-24PD	NO	Yes	Yes	NO
DB-16P8R	NO	Yes	Yes	NO
DB-24R	NO	Yes	NO	NO
DB-24RD	NO	Yes	Yes	NO
DB-24C	Yes	Yes	Yes	NO
DB-24PR	Yes	Yes	NO	NO
DB-24PRD	NO	Yes	Yes	NO
DB-24POR	Yes	Yes	Yes	NO
DB-24SSR	NO	Yes	Yes	NO
DN-100	NO	NO	NO	Yes