LYNC-712/715-1900G4 Series

**Fanless 12.1"/15" Industrial Panel PC with
Intel® J1900 Quad-Core™ Processor**

User's Manual

Version 1.1

Revision History

Version	Time	Description
1.0	2015/11	Initial release
1.1	2016/09	<ul style="list-style-type: none">• Updated 1.3. Specifications• Added driver path for Windows 10 in 2.3. Driver Installation Note

Revision History	ii
Contents	i
Preface.....	iii
Copyright Notice	iii
Declaration of Conformity	iii
CE.....	iii
FCC Class A	iii
RoHS	iv
SVHC / REACH	iv
Important Safety Instructions	v
Warning.....	vi
Lithium Battery Replacement.....	vi
Technical Support	vi
Warranty.....	vii
Chapter 1 - Introduction.....	1
1.1. The Computer	2
1.2. About this Manual	2
1.3. Specifications.....	3
1.4. Inside the Package	5
1.5. Ordering Information	5
1.5.1. Optional Accessories	6
1.5.2. Configure-to-Order Service.....	6
Chapter 2 - Getting Started.....	7
2.1. Dimensions	8
2.2. Tour the Computer	10
2.2.1. Front View.....	10
2.2.2. Rear View	11
2.2.3. Bottom View.....	12
2.2.4. Side View	13
2.2.5. Top View	13
2.3. Driver Installation Note.....	14
Chapter 3 - Engine of the Computer	17
3.1. Board Layout.....	18
3.1.1. CPU Module (EmQ-i230B)	18
3.1.2. Daughterboard (SCDB-141B).....	18
3.1.3. Carrier Board (PBQ-9014).....	19
3.2. Jumpers and Connectors.....	20
3.2.1. Jumpers	20
3.2.2. Connectors	24

Chapter 4 - Installation and Maintenance	31
4.1. Use Onboard Jumpers and Connectors	32
4.2. Install Hardware	33
4.2.1. Install SSD or HDD	33
4.2.2. Install CFast Card	34
4.2.3. Install Wi-Fi Module	35
4.2.4. Install Memory Module.....	36
4.3. Mount the Computer	39
4.3.1. Panel Mounting.....	39
4.3.2. VESA Mounting.....	41
4.4. Wire DC-Input Power Source.....	44
Chapter 5 - BIOS	45
5.1. Main	48
5.2. Advanced	49
5.2.1. Boot Configuration	50
5.2.2. PCI Express Configuration	50
5.2.3. USB Configuration	50
5.2.4. SATA Configuration.....	51
5.2.5. SIO FINTEK81866D	51
5.2.6. USB TO UART XR21V1412	51
5.3. Security.....	54
5.4. Power	55
5.5. Boot.....	56
5.6. Exit.....	57
Appendices	59
Appendix A: WIFI-AT2350 Hardware Installation.....	60
A.1. Install WIFI-AT2350.....	60
Appendix B: PenMount Utilities.....	64
B.1. PenMount Control Panel	64
B.2. PenMount Gesture	69

Copyright Notice

All Rights Reserved.

The information in this document is subject to change without prior notice in order to improve the reliability, design and function. It does not represent a commitment on the part of the manufacturer.

Under no circumstances will the manufacturer be liable for any direct, indirect, special, incidental, or consequential damages arising from the use or inability to use the product or documentation, even if advised of the possibility of such damages.

This document contains proprietary information protected by copyright. All rights are reserved. No part of this document may be reproduced by any mechanical, electronic, or other means in any form without prior written permission of the manufacturer.

Declaration of Conformity

CE

The CE symbol on your product indicates that it is in compliance with the directives of the Union European (EU). A Certificate of Compliance is available by contacting Technical Support.

This product has passed the CE test for environmental specifications when shielded cables are used for external wiring. We recommend the use of shielded cables. This kind of cable is available from ARBOR. Please contact your local supplier for ordering information.

Warning

This is a class A product. In a domestic environment this product may cause radio interference in which case the user may be required to take adequate measures.

FCC Class A

This device complies with Part 15 of the FCC Rules. Operation is subject to the following two conditions:

- (1) This device may not cause harmful interference, and
- (2) This device must accept any interference received, including interference that may cause undesired operation.

NOTE:

This equipment has been tested and found to comply with the limits for a Class A digital device, pursuant to Part 15 of the FCC Rules. These limits are designed to provide reasonable protection against harmful interference when the equipment is operated in a commercial environment. This equipment generates, uses, and can radiate radio frequency energy and, if not installed and used in accordance with the instruction manual, may cause harmful interference to radio communications. Operation of this equipment in a residential area is likely to cause harmful interference in which case the user will be required to correct the interference at his own expense.

RoHS

ARBOR Technology Corp. certifies that all components in its products are in compliance and conform to the European Union's Restriction of Use of Hazardous Substances in Electrical and Electronic Equipment (RoHS) Directive 2002/95/EC.

The above mentioned directive was published on 2/13/2003. The main purpose of the directive is to prohibit the use of lead, mercury, cadmium, hexavalent chromium, polybrominated biphenyls (PBB), and polybrominated diphenyl ethers (PBDE) in electrical and electronic products. Member states of the EU are to enforce by 7/1/2006.

ARBOR Technology Corp. hereby states that the listed products do not contain unintentional additions of lead, mercury, hex chrome, PBB or PBDB that exceed a maximum concentration value of 0.1% by weight or for cadmium exceed 0.01% by weight, per homogenous material. Homogenous material is defined as a substance or mixture of substances with uniform composition (such as solders, resins, plating, etc.). Lead-free solder is used for all terminations (Sn(96-96.5%), Ag(3.0-3.5%) and Cu(0.5%)).

SVHC / REACH

To minimize the environmental impact and take more responsibility to the earth we live, Arbor hereby confirms all products comply with the restriction of SVHC (Substances of Very High Concern) in (EC) 1907/2006 (REACH --Registration, Evaluation, Authorization, and Restriction of Chemicals) regulated by the European Union.

All substances listed in SVHC < 0.1 % by weight (1000 ppm)

Important Safety Instructions

Read these safety instructions carefully

1. Read all cautions and warnings on the equipment.
2. Place this equipment on a reliable surface when installing. Dropping it or letting it fall may cause damage
3. Make sure the correct voltage is connected to the equipment.
4. For pluggable equipment, the socket outlet should be near the equipment and should be easily accessible.
5. Keep this equipment away from humidity.
6. The openings on the enclosure are for air convection and protect the equipment from overheating. **DO NOT COVER THE OPENINGS.**
7. Position the power cord so that people cannot step on it. Do not place anything over the power cord.
8. Never pour any liquid into opening. This may cause fire or electrical shock.
9. Never open the equipment. For safety reasons, the equipment should be opened only by qualified service personnel.
10. If one of the following situations arises, get the equipment checked by service personnel:
 - a. The power cord or plug is damaged.
 - b. Liquid has penetrated into the equipment.
 - c. The equipment has been exposed to moisture.
 - d. The equipment does not work well, or you cannot get it to work according to the user's manual.
 - e. The equipment has been dropped or damaged.
 - f. The equipment has obvious signs of breakage.
11. Keep this User's Manual for later reference.

Warning

The Panel PC and its components contain very delicately Integrated Circuits (IC). To protect the Panel PC and its components against damage caused by static electricity, you should always follow the precautions below when handling it:

1. Disconnect your Panel PC from the power source when you want to work on the inside.
2. Use a grounded wrist strap when handling computer components.
3. Place components on a grounded antistatic pad or on the bag that came with the Panel PC, whenever components are separated from the system.

Lithium Battery Replacement

Incorrect replacement of the lithium battery may lead to a risk of explosion.

The lithium battery must be replaced with an identical battery or a battery type recommended by the manufacturer.

Do not throw lithium batteries into the trash can. It must be disposed of in accordance with local regulations concerning special waste.

Technical Support

If you have any technical difficulties, please consult the user's manual first at:
<ftp://ftp.arbor.com.tw/pub/manual>

Please do not hesitate to call or e-mail our customer service when you still cannot find out the answer.

<http://www.arbor-technology.com>

E-mail:info@arbor.com.tw

Warranty

This product is warranted to be in good working order for a period of one year from the date of purchase. Should this product fail to be in good working order at any time during this period, we will, at our option, replace or repair it at no additional charge except as set forth in the following terms. This warranty does not apply to products damaged by misuse, modifications, accident or disaster.

Vendor assumes no liability for any damages, lost profits, lost savings or any other incidental or consequential damage resulting from the use, misuse of, or inability to use this product. Vendor will not be liable for any claim made by any other related party.

Vendors disclaim all other warranties, either expressed or implied, including but not limited to implied warranties of merchantability and fitness for a particular purpose, with respect to the hardware, the accompanying product's manual(s) and written materials, and any accompanying hardware. This limited warranty gives you specific legal rights.

Return authorization must be obtained from the vendor before returned merchandise will be accepted. Authorization can be obtained by calling or faxing the vendor and requesting a Return Merchandise Authorization (RMA) number. Returned goods should always be accompanied by a clear problem description.

This page is intentionally left blank.

Chapter 1

Introduction

1.1. The Computer

ARBOR's LYNC-712 & 715-1900G4 is cost-effective industrial panel PC to feature light weight and slim form factor. The computer comes with rich I/O to meet the demand of the automation and manufacturing process required in modern factories. The system includes four serial ports, five USB ports, one DVI-I port and two LAN ports for wired data connection. The computer also supports one CFast card and features one 2.5" drive bay for extensive data storage. One PCI Express Mini-card is also built on the main board of the computer to enhance the system with Wi-Fi networking.



Product Highlights

- Fewer Cables, Fanless Design
- 12.1" (LYNC-712) or 15" (LYNC-715) 1024 x 768 XGA LCD Display w/ LED Backlight
- Front Bezel with Completely Covered Membrane
- Flush Front Panel, IP65-Compliant
- Brightness Control Button
- Outside-accessible Push-pull CFast Socket
- Outside-accessible USB port with rubber cover on the front bezel
- Serial Ports (RS-485), w/ Auto-flow Control
- 1 x MiniCard socket for WiFi module
- 2 x SMA Antenna Holes for Optional WiFi Function
- 9~36V Wide-Range DC Input with reverse protection

1.2. About this Manual

This manual is meant for the experienced users and integrators with hardware knowledge of personal computers. If you are not sure about the description in this manual, consult your vendor before further handling.

We recommend that you keep one copy of this manual for the quick reference for any necessary maintenance in the future. Thank you for choosing ARBOR products.

1.3. Specifications

System	
CPU	Intel® J1900 Quad-Core™ Processor 2.0GHz
Memory	1 x 4GB DDR3L SO-DIMM memory module (installed)
LAN	2 x Realtek® 8111E GbE controllers
Watchdog Timer	1~255 levels reset
Storage	
1st Device	1 x outside-accessible CFast slot
2nd Device	1 x 2.5" drive bay
Audio	
Speaker	2 x 1.5W speakers (optional)
LCD Display	
Size/Type	LYNC-712: 12.1" TFT LCD Panel LYNC-715: 15" TFT LCD Panel
Max. Resolution	1024 x 768, XGA
Max. Colors	16.7M
Luminance	LYNC-712: 350 cd/m ² LYNC-715: 420 cd/m ²
Touch Screen	5-wire Analog Resistive
View Angle (U/D/R/L)	80°/80°/80°/80°
Button & Indicator	
Function Key	Brightness up/down, Screen on/off
LED Indicator	Power on LED
Power System	
Power Input	DC 9~36V
Certification	
EMC / EMI	UL, CE, FCC Class A
Expansion	
Expansion Bus	1 x Mini-card socket
External I/O	
Serial Ports	4 x DB-9 connectors for COM1~4 (COM1 ~ COM4 are RS-232/485 configurable)
USB Ports	4 x Type-A USB 2.0 ports (rear)
	1 x Type-A USB 2.0 port with rubber cover on front bezel

Introduction

LAN	2 x RJ-45 GbE ports
DVI	1 x DVI connector
WiFi	2 x SMA antenna holes for optional WiFi function
Mechanical	
Mounting Type	Panel Mounting and VESA-75/100 Mounting
Chassis	Panel-mounting chassis, aluminum front bezel and SECC steel chassis
Dimension (W x H x D)	LYNC-712: 325.88 x 258.86 x 44.00 mm (12.8" x 10.2" x 2.26") LYNC-715: 389.93 x 309.93 x 46.80 mm (15.4" x 12.2" x 2.37")
Weight (Net)	LYNC-712: 2.2 kg (without VESA bracket) LYNC-715: 3.4 kg (without VESA bracket)
Environmental	
Operating Temp.	-20 ~ 55°C (-4 ~ 131°F)
Storage Temp.	-20 ~ 70°C (-4 ~ 158°F)
Operating Humidity	10 ~ 95% RH @ 55°C (non-condensing)
Vibration	5 ~ 500Hz, 2Grms X,Y,Z axis (with CFast/SSD)
Shock	Operating 20G, 11ms X,Y,Z axis (with CFast/SSD)
OS Support	
Windows 7 / Windows 8.1 / Windows 10/ Linux (Kernel: 3.1X)	

1.4. Inside the Package

Upon opening the package, carefully inspect the contents. If any of the items is missing or appears damaged, contact your local dealer or distributor. The package should contain the following items:



LYNC-712-
1900G4



LYNC-715-
1900G4

1 x LYNC-712 or 715-1900G4
industrial panel PC



1 x **Accessory Box** that contains the
following items:

- driver CD
- user's manual
- screws/cable
- 3-pin plug for terminal block

1.5. Ordering Information

LYNC-712-1900G4 12.1" Intel® J1900 Quad-Core™ Processor industrial
panel PC

LYNC-715-1900G4 15" Intel® J1900 Quad-Core™ Processor industrial
panel PC

1.5.1. Optional Accessories

The following items are normally optional, but some vendors may include them in the standard package, or some vendors may not carry all the items.

PAC-P060W-02 60W AC/DC power adapter kit
Power input: 100 ~ 240 VAC
Power output: 12VDC, 5A



VMB-712 LYNC-712 VESA-mount bracket kit
Material: stainless steel
VESA support: 75 x 75 mm / 100 x 100 mm



VMB-715 LYNC-715 VESA-mount bracket kit
Material: stainless steel
VESA support: 75 x 75 mm / 100 x 100 mm



1.5.2. Configure-to-Order Service

Make the computer more tailored to your needs by selecting one or more components from the list below to be fabricated to the computer.

80GB SSD Intel® 2.5" 80GB SATAIII SSD Kit



WIFI-AT2350 Atheros AR9462 WiFi module w/ 20cm & 30cm internal wiring



ANT-D11 1 x 2.4G/5G Dual-band WiFi antenna



ADK-712 LYNC-71x Audio Kit



Chapter 2

Getting Started

2.1. Dimensions

The following illustration shows the dimensions of the computer, with the measurements in width, depth, and height called out.

LYNC-712-1900G4

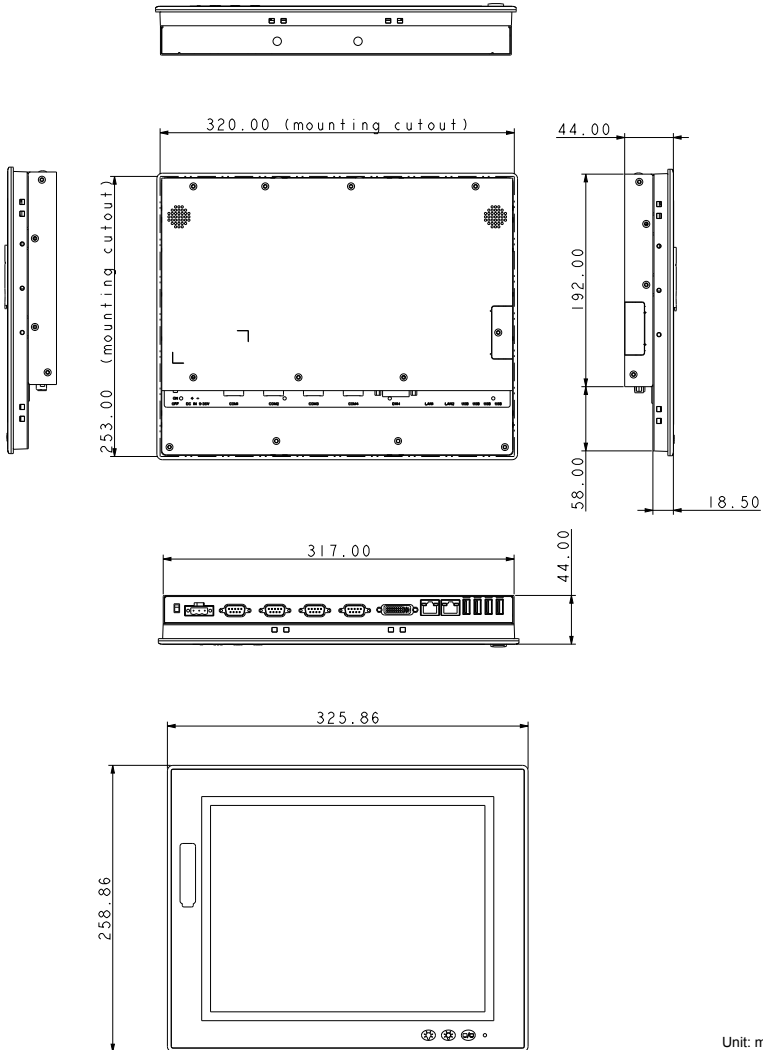

Unit: mm

LYNC-715-1900G4

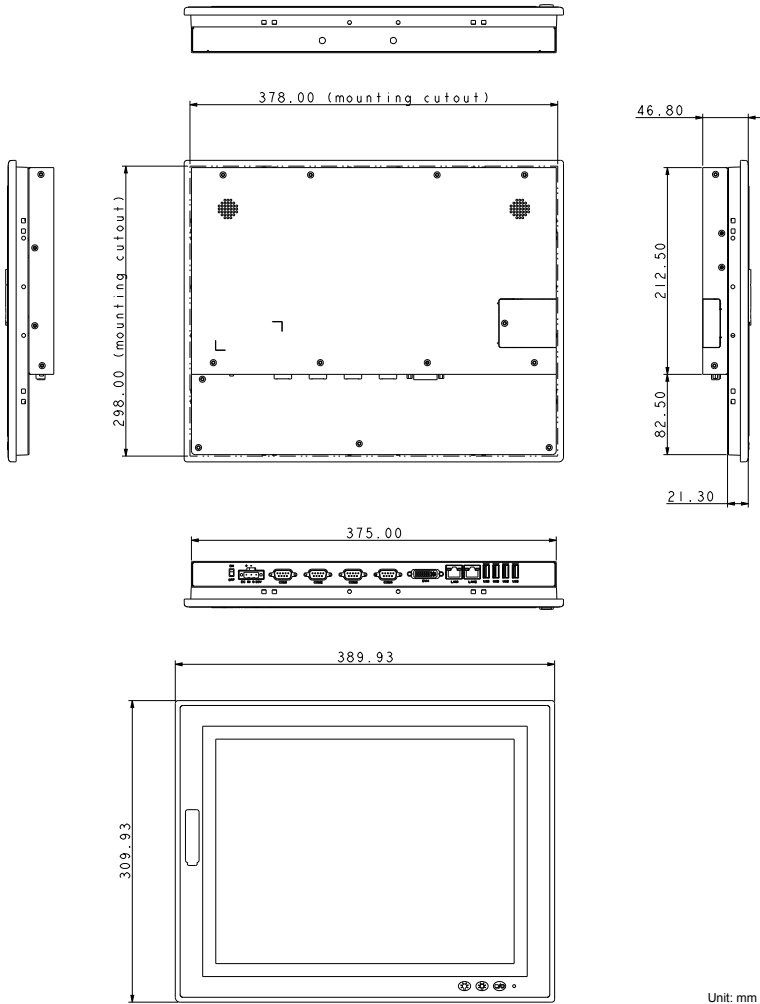

Unit: mm

2.2. Tour the Computer

Take a look around the computer and find the external controls and connectors.

2.2.1. Front View

On the front side of the computer is a LCD display, a few function keys and one USB port recessed in the lower-right of the bezel.



LYNC-712-1900G4



LYNC-715-1900G4



Use the function keys to launch the following actions from the computer:

Icon	Description
	Turns on/off the LCD display.
	Decreases LCD backlight.
	Increases LCD backlight.

2.2.2. Rear View

LYNC-712-1900G4

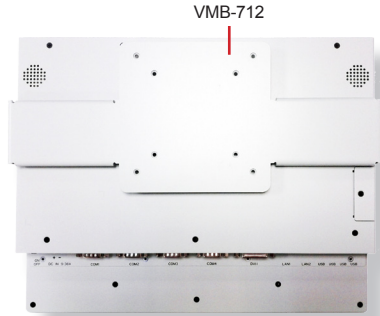
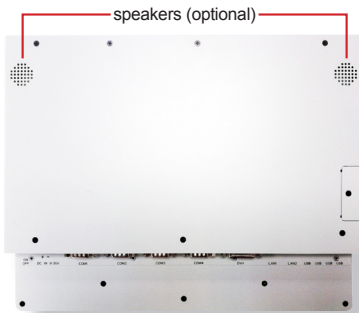

LYNC-715-1900G4

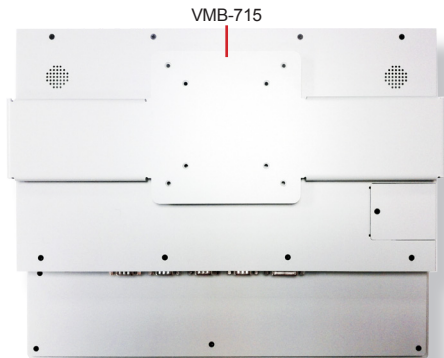
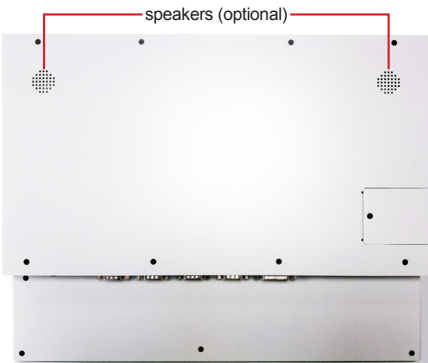

2.2.3. Bottom View

The bottom side of the computer is where the computer's I/O ports are.

LYNC-712-1900G4

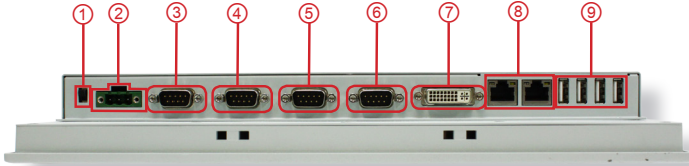

LYNC-715-1900G4

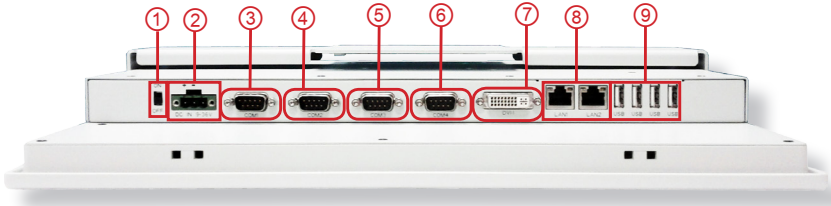

No.	Description
①	Power switch
②	DC-IN
③	COM1
④	COM2
⑤	COM3
⑥	COM4
⑦	DVI port
⑧	2 x LAN ports
⑨	4 x USB ports

2.2.4. Side View

LYNC-712-1900G4

LYNC-715-1900G4



2.2.5. Top View

antenna holes w/ SMA connectors

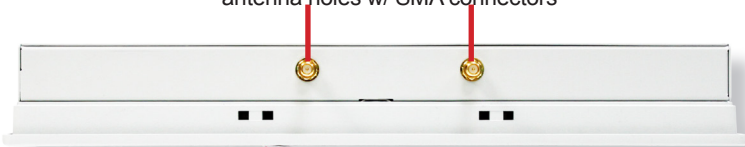

2.3. Driver Installation Note

The computer supports the operating systems Windows 7, Windows 8.1 and Windows 10. Find the necessary device drivers on the CD that comes with your purchase. Always follow the sequence below to install all drivers to prevent errors:

Chipset→Graphics→LAN→touch

Windows 7

Device	Driver Path	
Chipset	win7\Intel_Chipset_win7_8_8.1_32_64bit_V9.4.4.1006\infinst_autol.exe	
Ethernet	32bit	\Realtek LAN\Win7\setup.exe
	64bit	\Realtek LAN\Win7\setup.exe
TXE	\TXE_Win7_8_8.1_1.1.0.1089\SetupTXE.exe	
TXE Update	32bit	win7\kmdf-1.11-Win-6.1-x86.msu
	64bit	win7\kmdf-1.11-Win-6.1-x64.msu
Graphics	32bit	win7\Intel_EMGD_WIN7_32bit_V_36_15_0_1073\Setup.exe
	64bit	win7\Intel_EMGD_Win7_64bit_V_37_15_0_1073\Setup.exe
Touch	\5 Wire Resistive Touch\Setup.exe	
USB to UART	\USB TO UART\EXE\xrusbser_ver2200_installer.exe	

Windows 8.1

Device	Driver Path	
Chipset	win8\Intel_Chipset_win7_8_8.1_32_64bit_V9.4.4.1006\infinst_autol.exe	
Ethernet	32bit	\Realtek LAN\Win8_8.1\setup.exe
	64bit	\Realtek LAN\Win8_8.1\setup.exe
TXE	\TXE_Win7_8_8.1_1.1.0.1089\SetupTXE.exe	
Graphics	32bit	win8\gfx_win8_8.1_32_15.33.19.3540\Setup.exe
	64bit	win8\gfx_win8_8.1_64_15.33.19.3540\Setup.exe
MBI	win8\Intel_MBI_Win 8_8.1_32_64bit\Setup.exe	
Touch	\5 Wire Resistive Touch\Setup.exe	
USB to UART	\USB TO UART\EXE\xrusbser_ver2200_installer.exe	

Windows 10

Device	Driver Path
Chipset	\\win10\Inf\SetupChipset.exe
Ethernet	\\Realtek LAN\Win10\Install_Win10_10009_07202016\setup.exe
TXE	\\win10\TXE_1.1.4.1145_Win7_8.1_10\Installer\SetupTXE.exe
Graphic	\\win10\Graphics\win64_153343.4425.exe
MBI	\\win10\MBI\15hn02w.exe
Touch	\\win10\PenMount-Windows-Universal-Driver-V2.4.5.350-WHQL\Setup.exe
USB to UART	\\USB TO UART\EXE\xrusbser_ver2200_installer.exe

*Note: Refer to [Appendix B: PenMount Utilities on page 64](#) for how to use touch panel.

This page is intentionally left blank.

Chapter 3

Engine of the Computer

3.1. Board Layout

The engine of the computer is constructed by the CPU module EmQ-i230B, the carrier board PBQ-9014 and the optional daughterboard SCDB-141B.

3.1.1. CPU Module (EmQ-i230B)

Top View

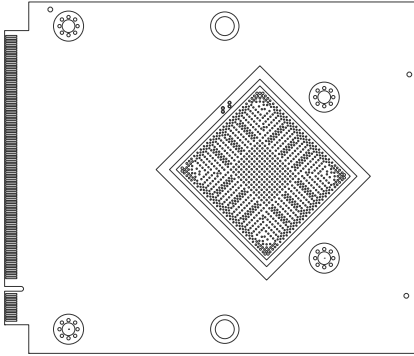

Bottom View

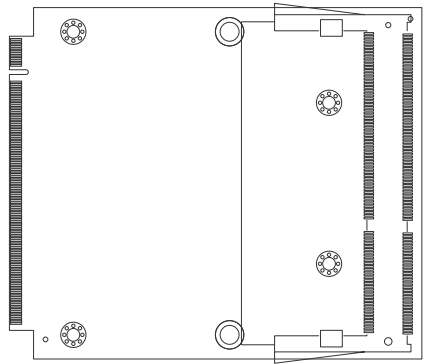

3.1.2. Daughterboard (SCDB-141B)

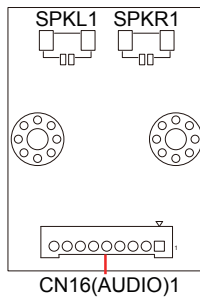

3.1.3. Carrier Board (PBQ-9014)

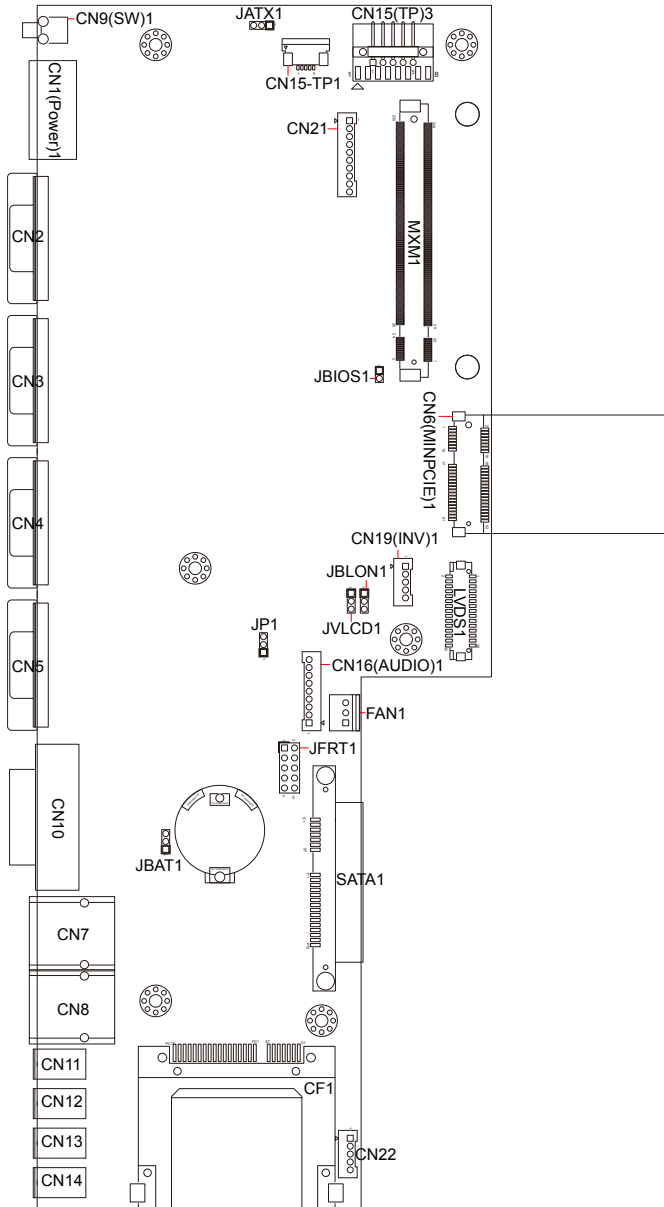

3.2. Jumpers and Connectors

This chapter will explicate each of the jumpers and connectors on the carrier board of the computer.

3.2.1. Jumpers

JATX1

Function: AT/ATX MODE

Selection

Jumper Type: 2.00mm-pitch

1x3-pin header

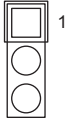

Setting:

Pin	Description	Setting
1-2	AT (default)	

2-3	ATX	
-----	-----	--

JBIOS1

Function: BIOS selector

Jumper Type: 2.00mm-pitch

1x2-pin open type jumper



Setting:

Pin	Description	Setting
ON	Boot the computer from the carrier board's flash ROM BIOS. (default)	<p>The short-circuit-cap is used on both pins.</p>

OFF	Boot the computer from the CPU board's flash ROM BIOS.	<p>The short-circuit-cap is removed.</p>
-----	--	--

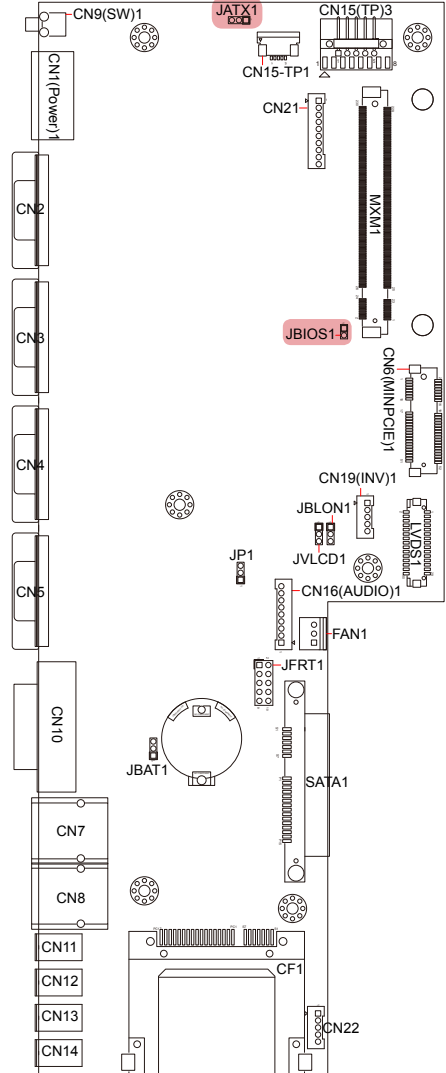

JFRT1

Function: front panel LED indication

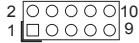

Jumper Type: 2.54mm-pitch 2x5-pin header

Setting:

Pin	Description	Setting
1-2	system reset	
3-4	power LED+	
5-6	HDD LED+	
7-8	speaker	
9-10	power button	

JBAT1

Function: COMS setting
Jumper Type: 2.00mm-pitch 1x3-pin header

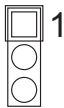

Setting:

Pin	Description	Setting
1-2	keep CMOS (default)	
2-3	clear CMOS	

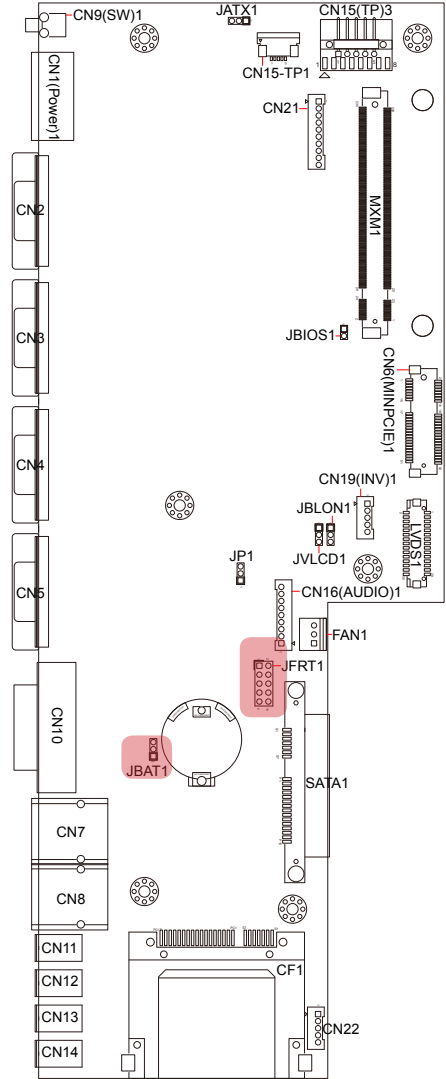

JVLCD1

Function: LCD power selection
Jumper Type: 2.00mm-pitch
 1x3-pin header

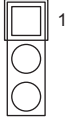

Setting:

Pin	Description	Setting
1-2	5V	

2-3	3.3V (default)	
-----	-------------------	--

JBLON1

Function: LCD backlight
 activeness selection
Jumper Type: 2.00mm-pitch
 1x3-pin header

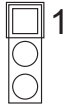

Setting:

Pin	Description	Setting
1-2	negative active	

2-3	positive active (default)	
-----	------------------------------	--

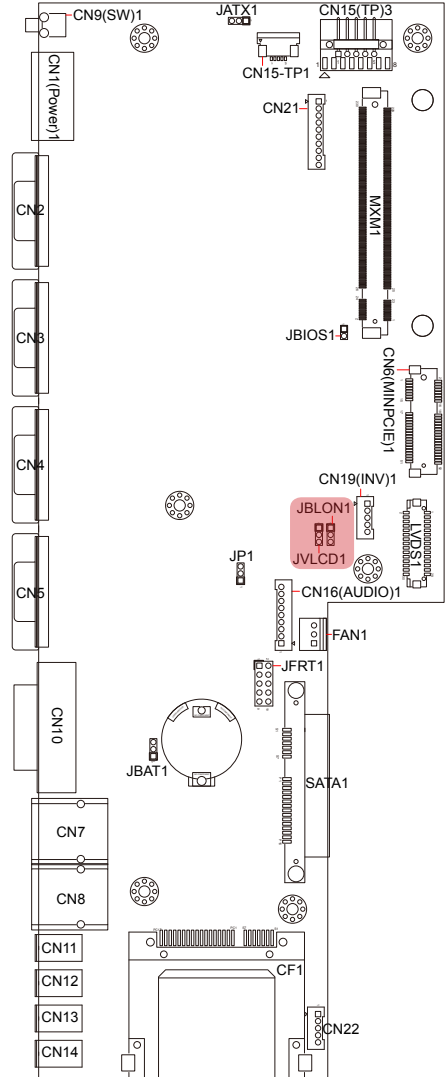

JP1

Function: COM1 function selection

Jumper Type: 2.00mm-pitch 1x3-pin header

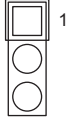

Setting:

Pin	Description	Setting
1-2	for factory testing	
2-3	normal (default)	

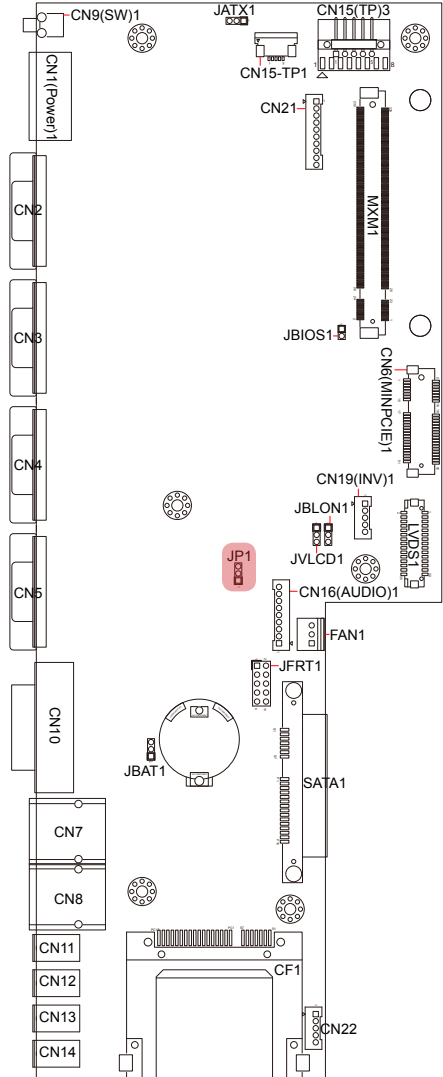

3.2.2. Connectors

CN19(INV)1

Function: inverter connector

Connector Type: 2.00mm-pitch 1x5-pin 4-wall wafer connector

Setting:

Pin	Description
1	+12V/+5V
2	GND
3	BL-ON
4	BL-Control
5	GND

CN1(Power)1

Function: power input

Connector Type: 5.00mm-pitch 3-pole male-type euro-style terminal block

Setting:

Pin	Description
1	POWER+(9~36V)
2	POWER-
3	GND

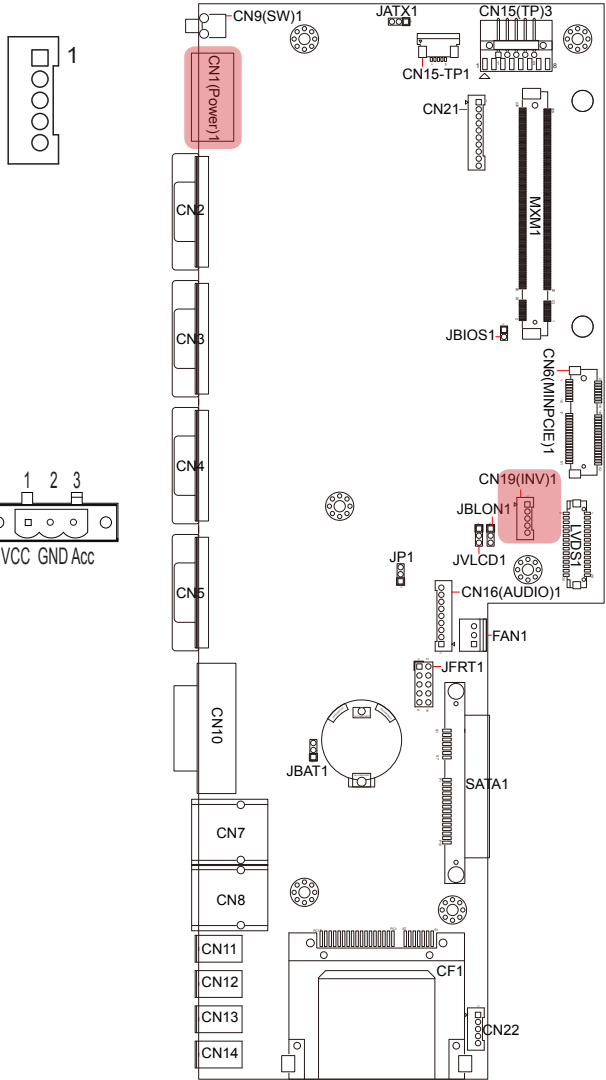

CN21

Function: USB 3.0 connectors

Connector Type: 1x10-pin header

Setting:

Pin	Desc.	Pin	Desc.
1	VCC5	6	NC
2	D-	7	NC
3	D+	8	NC
4	GND	9	NC
5	NC	10	GND

CN21(USB)1

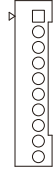

CN22

Function: USB connectors

Connector Type: 2.54mm-pitch 1x5-pin header

Setting:

Pin	Description
1	5VCC
2	Data-
3	Data+
4	GND
5	GND

CN22(USB)1



CN15-TP1

Function: membrane connector

Connector Type: 1x5-pin FPC downside connector

Setting:

Pin	Description
1	Panel-PWM-
2	Panel-PWM+
3	Power SW
4	Power LED
5	GND

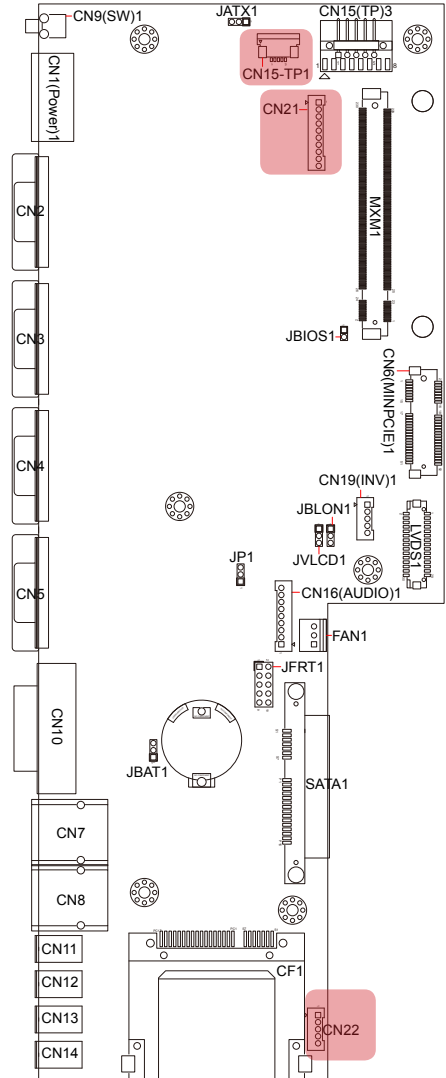
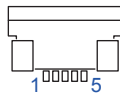

CN15(TP)3

Function: touch panel connector

Connector Type: 2.54mm-pitch 1x5-pin header

Setting:

Pin	Description
1	Y+
2	X+
3	Sense
4	Y-
5	X-

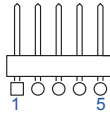

LVDS1

Function: LCD connector

Connector Type: DF-13-30DP-1.25V connector



Setting:

Pin	Description	Pin	Description
2	VDD	1	VDD
4	TX2CLK+	3	TX1CLK+
6	TX2CLK-	5	TX1CLK-
8	GND	7	GND
10	TX2D0+	9	TX1D0+
12	TX2D0-	11	TX1D0-
14	GND	13	GND
16	TX2D1+	15	TX1D1+
18	TX2D1-	17	TX1D1-
20	GND	19	GND
22	TX2D2+	21	TX1D2+
24	TX2D2-	23	TX1D2-
26	GND	25	GND
28	TX2D3+	27	TX1D3+
30	TX2D3-	29	TX1D3-

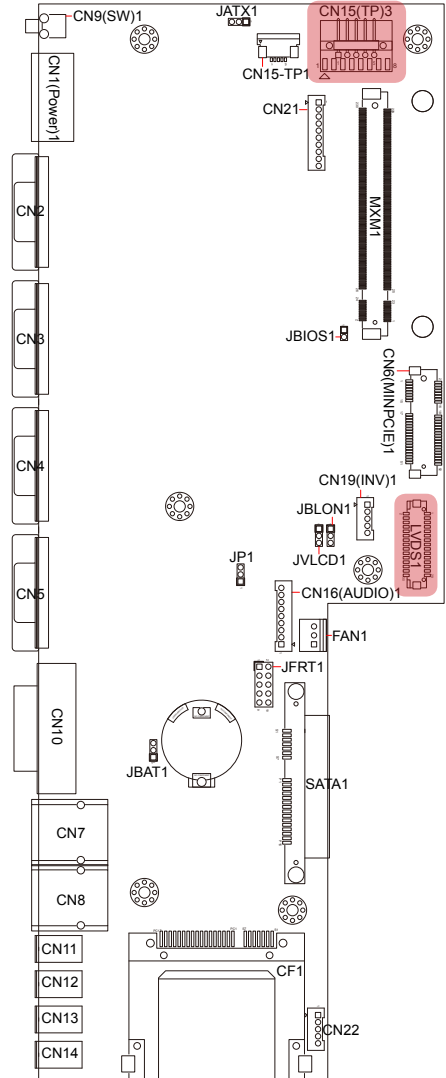

CN2~CN5

Function: COM1~4

Connector Type: 9-pin male-type DSUB connector

Setting: RS-232

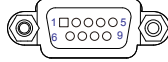

Pin	Description	Pin	Description
1	DCD	6	DSR
2	RXD	7	RTS
3	TXD	8	CTS
4	DTR	9	5V
5	GND	10	NC

Setting: RS-485

Pin	Description	Pin	Description
1	485-	6	NC
2	485+	7	NC
3	NC	8	NC
4	NC	9	NC
5	NC	10	NC

Note: To switch the COM port mode, please refer to [5.2.6. USB TO UART XR21V1412](#) on page [51](#).

CN10

Function: DVI-I port (digital)

Connector Type: 29-pin DIP-type female connector

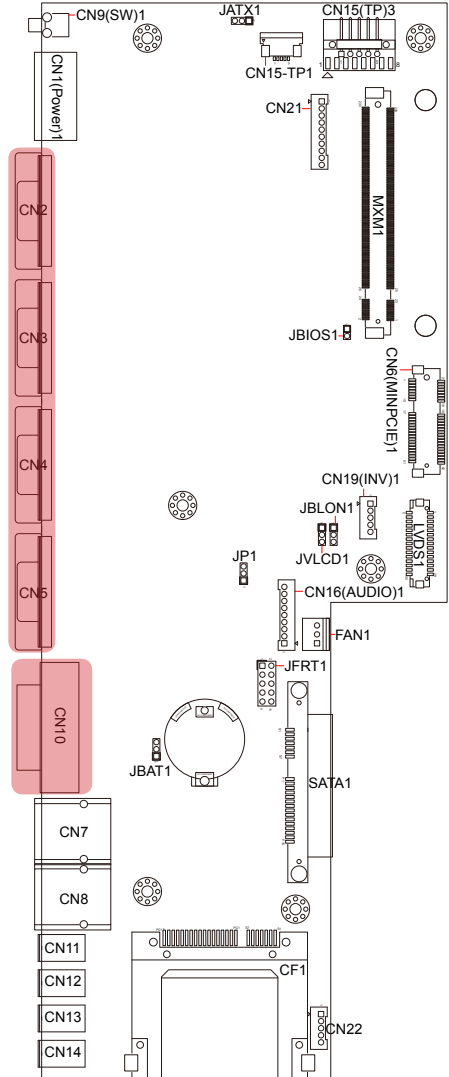

CN7~CN8

Function: RJ-45 Ethernet connectors

Connector Type:

10/100/1000Mbps Fast Ethernet

Setting:

Pin	Description	Pin	Description
1	MDI0	5	MDI2
2	MDI0#	6	MDI2#
3	MDI1	7	MDI3
4	MDI1#	8	MDI3#

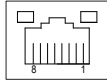

CN11~CN14

Function: USB2.0 ports

Connector Type: double stack

USB2.0 type A connector

Setting:

Pin	Description
1	5V
2	USB D-
3	USB D+
4	GND

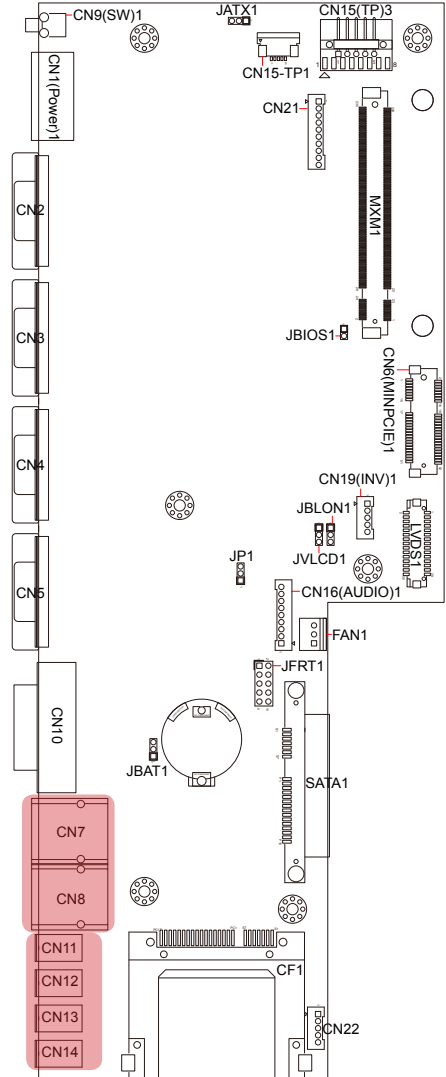
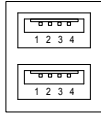

CN6(MINPCIE)1

Function: PCI Express MiniCard socket
Connector Type: onboard 0.8mm pitch 52-pin edge card connector

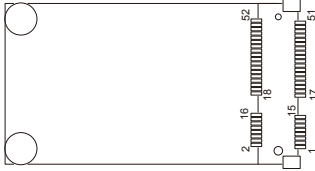

CF1

Function: CFast card Type I/II socket
Connector Type: 7+17-pin CFast card connector consisting of a SATA compatible 7-pin signal connector and a 17-pin power control connector.

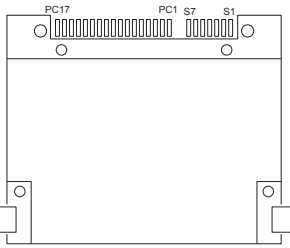

SATA1

Function: S-ATA1 connector
Connector Type: SATA port with data + power vertical connector (7+15pin)

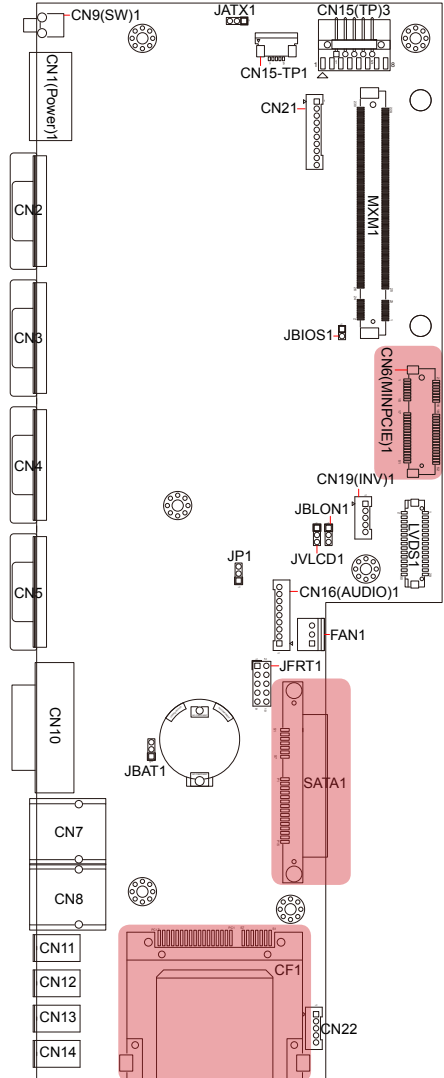
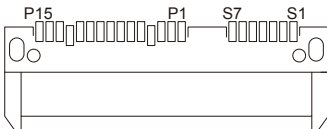

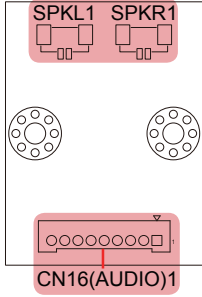

CN16(Audio)1

Function: audio connector
Connector Type: 2.00mm-pitch
 1x9-pin 4-wall wafer connector
Setting:

Pin	Description
1	12VCC
2	3VCC
3	HDA_SYNC
4	HAD_SDOUT
5	GND
6	HDA_CLK
7	GND
8	HDA_RST#
9	HDA_SDINO

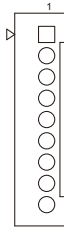

SPKL1 or SPKR1

Function: left or right speaker connector

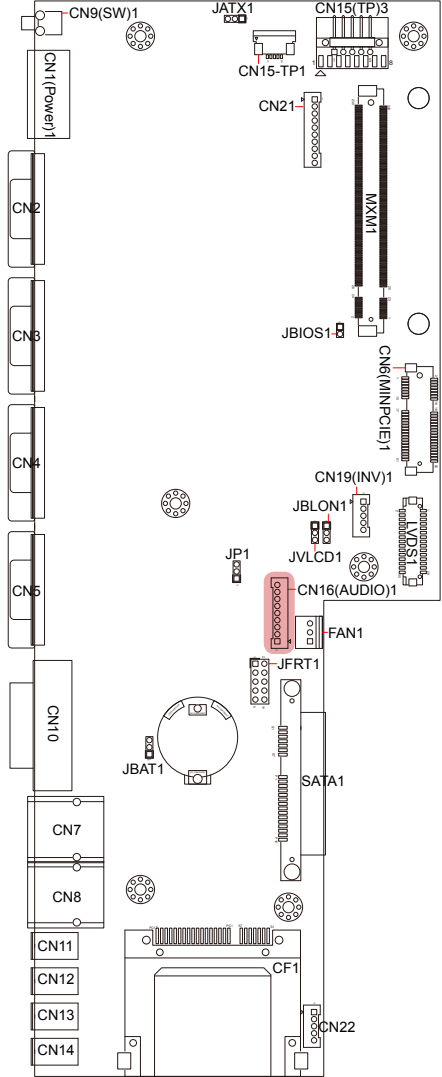

Chapter 4

Installation & Maintenance

4.1. Use Onboard Jumpers and Connectors

The computer's carrier board PBQ-9014 comes with some connectors to join some devices and also some jumpers to alter hardware configuration. Follow through the guide below to access these components inside the computer. Because LYNC-712 & 715 merely differ in size, the subsequent illustrations take LYNC-715 for instance.

1. Loosen and remove the 8 screws from the computer's rear panel. Then, loosen and remove the 4 screws from each of the left and right panel of the computer.

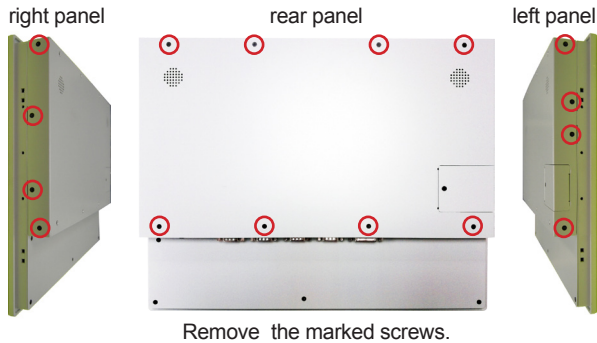

2. Dismount the rear cover from the computer. The inside of the computer comes to view.

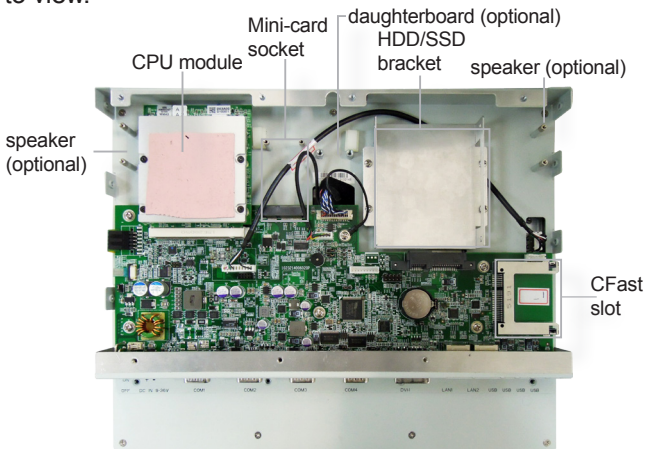

- Adjust the jumpers or use the connectors on the carrier board as described in [3.2.1. Jumpers](#) on page [20](#) and [3.2.2. Connectors](#) on page [24](#). Be noted that the speakers and daughterboard are parts of ADK-712 module. Refer to [1.5.2. Configure-to-Order Service on page 6](#) for details.

4.2. Install Hardware

The following sections will guide you through the basic hardware installation for the computer. Remember to turn off the panel PC before installing/removing inner hardware.

4.2.1. Install SSD or HDD

The computer supports a 2.5" HDD or SSD to work inside the computer. To install a 2.5" HDD or SSD to the computer, slide a 2.5" HDD or SSD storage device to the bracket. Fix them together by using four screws at the bracket's both sides. See the illustration below.

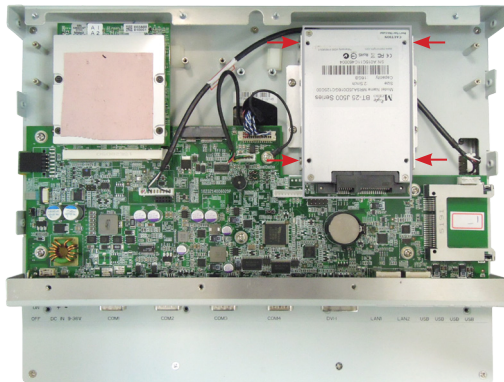

4.2.2. Install CFast Card

The computer comes with a CFast slot to power the computer with a CFast card. To install a CFast card to the computer:

1. Continued from the preceding section, locate the CFast slot on carrier board, or unscrew and take off the CFast slot door without the need to dismount rear panel.

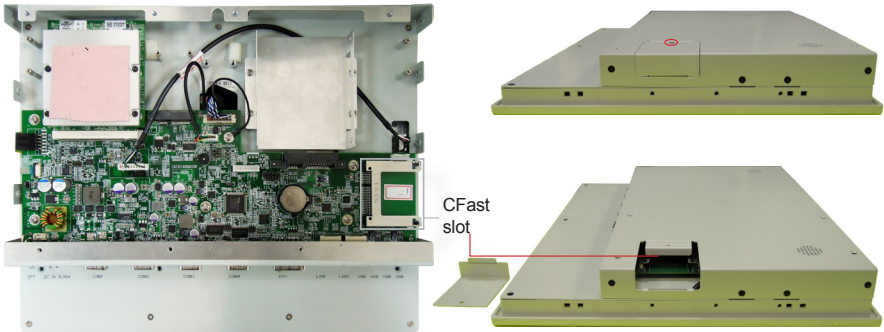

2. Have a CFast card. Push the CFast card into the slot so the card can be clicked in place. Push again to have the card ejected.

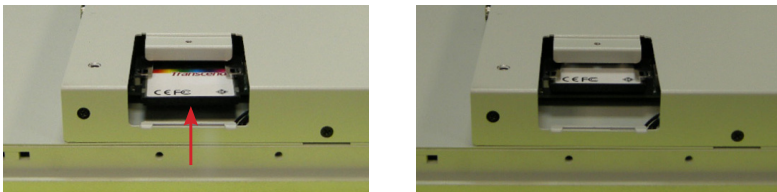

3. Restore the CFast slot door to the computer.

4.2.3. Install Wi-Fi Module

The computer comes with one Mini-card socket to load the computer with a wireless module of PCI Express Mini-card form factor. The configure-to-order Wi-Fi module available with the computer is WIFI-AT2350:



WIFI-AT2350
Atheros AR9462 WiFi module w/ 20cm & 30cm internal wiring

(See also [1.5.2. Configure-to-Order Service](#) on page [6](#).)

- If you have ordered the Wi-Fi module WIFI-AT2350, see [Appendix A: WIFI-AT2350 Hardware Installation](#) to know how to install the hardware and software for the module.

4.2.4. Install Memory Module

The computer comes with one Memory socket for Memory Module on the CPU module. To upgrade the Memory, please follow the steps as below.

To install a memory module:

1. Dismount the rear cover from the computer

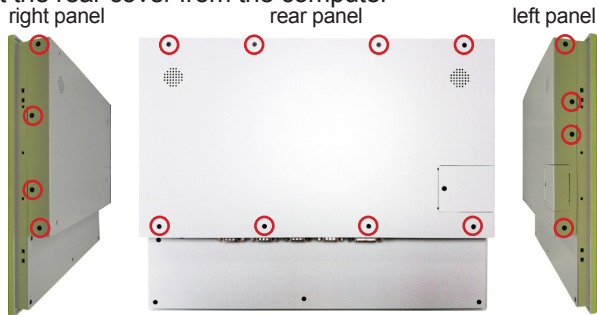

Remove the marked screws.

2. Find the CPU module as marked in the illustration below.

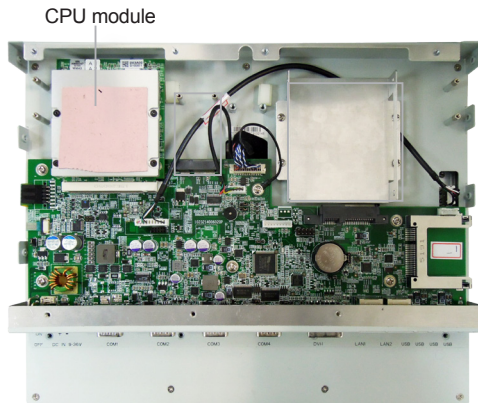

3. Remove four screws to loose the CPU module

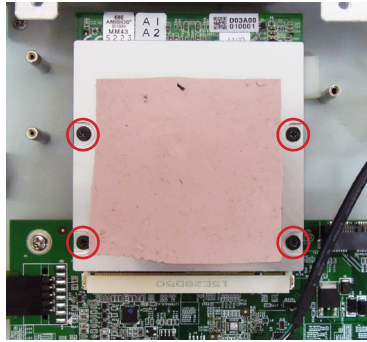

4. Remove the Heat sink and disassemble the CPU module.

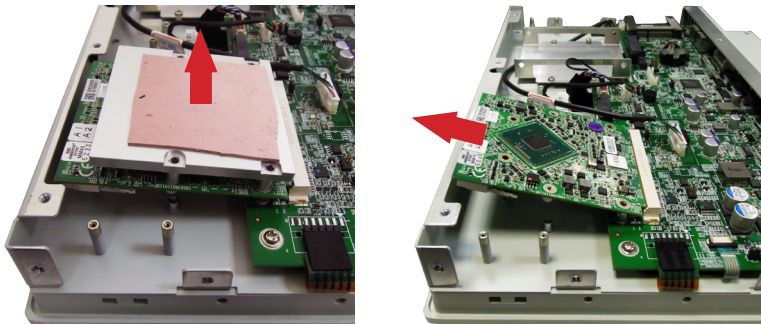

5. Flip the CPU module and locate the memory socket.



6. Remove the pre-install module and install the New Memory module.

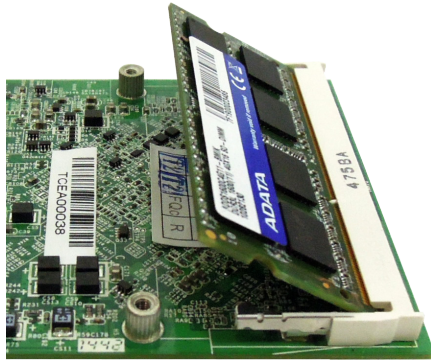

7. Instal the CPU module in reverse order.

4.3. Mount the Computer

Integrate the computer to where it works by mounting it to a wall in the surroundings or to the rear of a display monitor. Similarly, the subsequent illustrations only take LYNC-715 for instance.

4.3.1. Panel Mounting

1. Have the panel-mounting clamps included in accessory pack. Put the clamps into holes around edges of the panel PC as below.

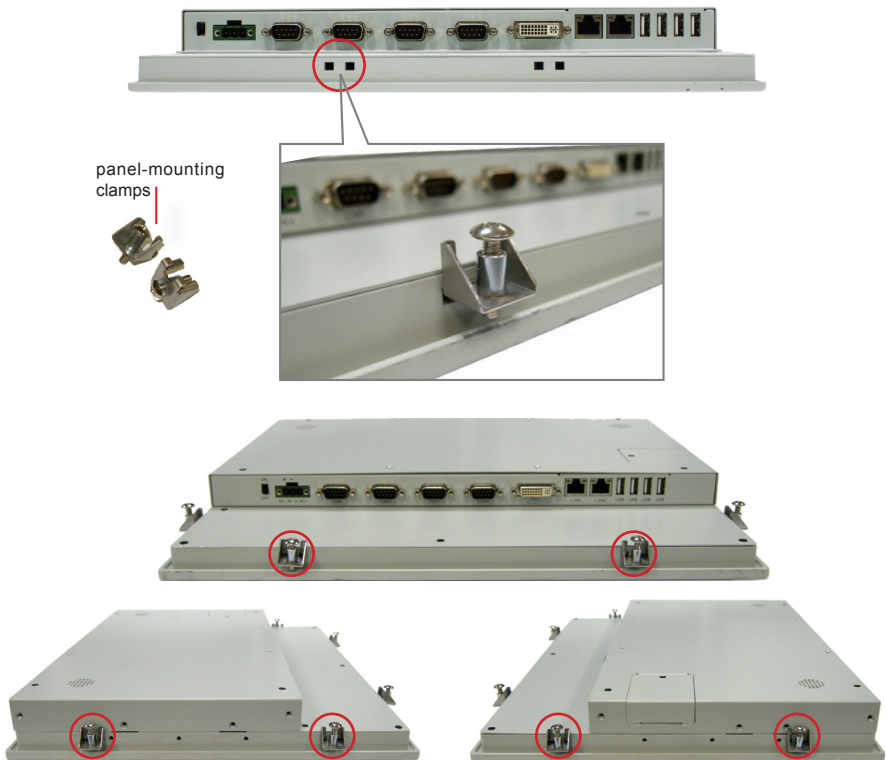

2. Put the panel PC into correct-sized frame on a wall or other devices, in this example — a transparent stand, and tightly screw panel-mounting clamps around edges.

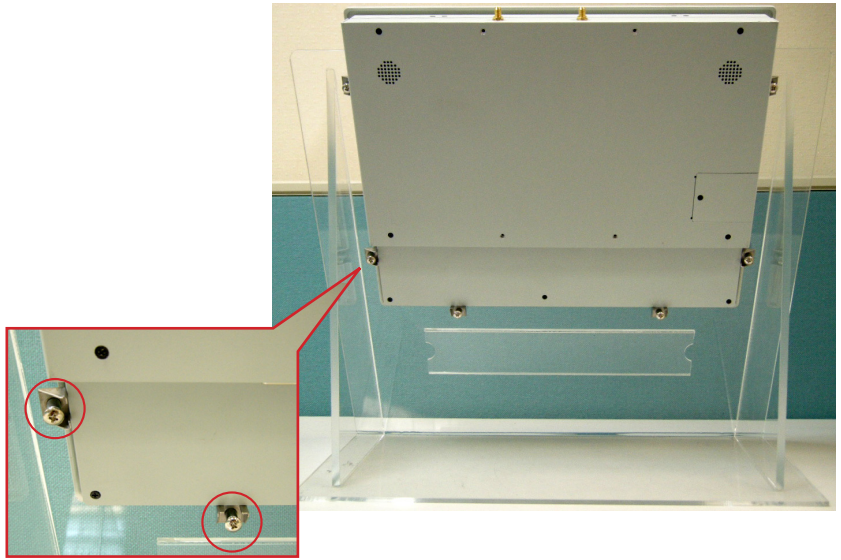

4.3.2. VESA Mounting

To support VESA-mounting, the computer needs a VESA bracket, which is available in [1.5.2. Configure-to-Order Service](#) on page [6](#), to enable 75 x 75mm and 100 x 100mm VESA applications.

4.3.2.1. Install VESA Bracket

Follow the guide below to install the VESA bracket to the computer:

1. Have the VESA-mount bracket, VMB-715 in this case, and the four mounting screws that come with it.



2. Place the computer on a flat surface, with the rear facing up.

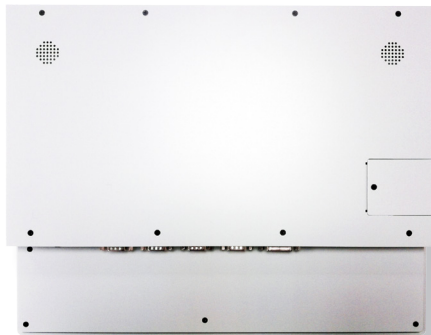

3. Place the VESA bracket onto the computer. Note that its installation direction should not block CFast card door.

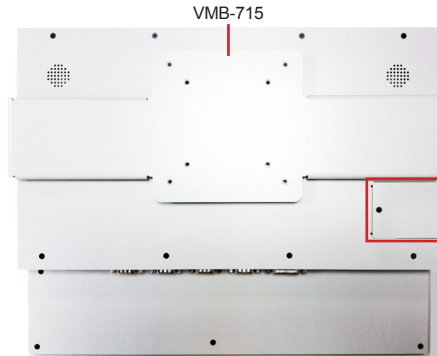

4. Fix the VESA bracket to the computer by two screws at each the left and right side of the computer.



Use another two screws on the left side.



Use two screws on the right side.

4.3.2.2. Use VESA Arm

To integrate the computer to a VESA arm:

1. Install the VESA-mount bracket to the computer as described in previous section.
2. Find the VESA mounting holes on the bracket.

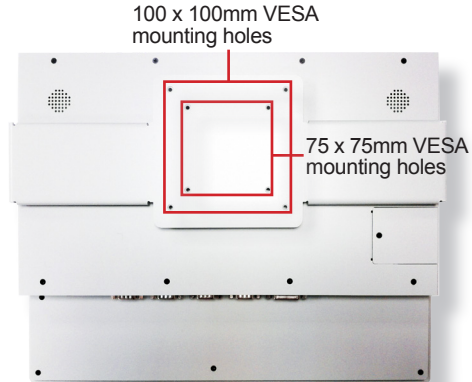

3. Attach the VESA arm to the rear of the computer by meeting the mounting holes on the VESA arm and VESA bracket.
4. Fix the assemblage with four screws.

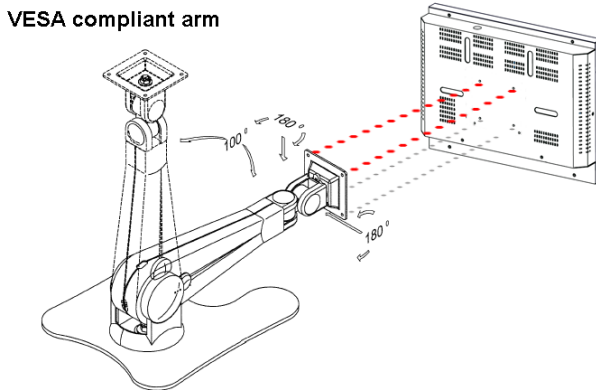

4.4. Wire DC-Input Power Source



Warning Only trained and qualified personnel are allowed to install or replace this equipment.

Follow the instructions below to connect the computer to a DC-input power source:

1. Before wiring, make sure the power source is disconnected.
2. Find the terminal block in the accessory box.
3. Use the wire-stripping tool to strip a short insulation segment from the output wires of the DC power source.
4. Identify the positive and negative feed positions for the terminal block connection.
5. Insert the exposed wires into the terminal block plugs. Only wires with insulation should extend from the terminal block plugs. Note that the polarities between the wires and the terminal block plugs must be positive to positive and negative to negative.
6. Use a slotted screwdriver to tighten the captive screws. Plug the terminal block firmly, which wired, into the receptacle on the rear panel.

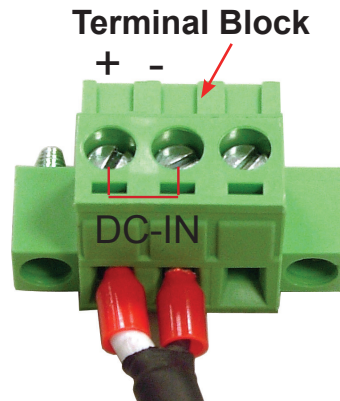
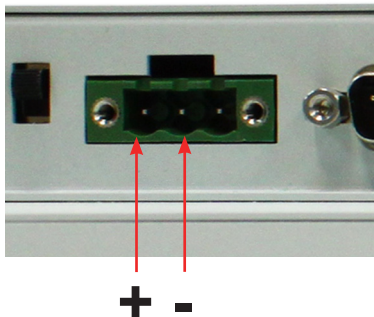

Chapter 5

BIOS

BIOS

The BIOS Setup utility for the computer is to configure the system settings stored in the system's BIOS ROM. The BIOS is activated once the computer powers on. When the computer is off, the battery on the main board supplies power to BIOS RAM.

To enter the BIOS Setup utility, keep hitting the “Esc” key upon powering on the computer.

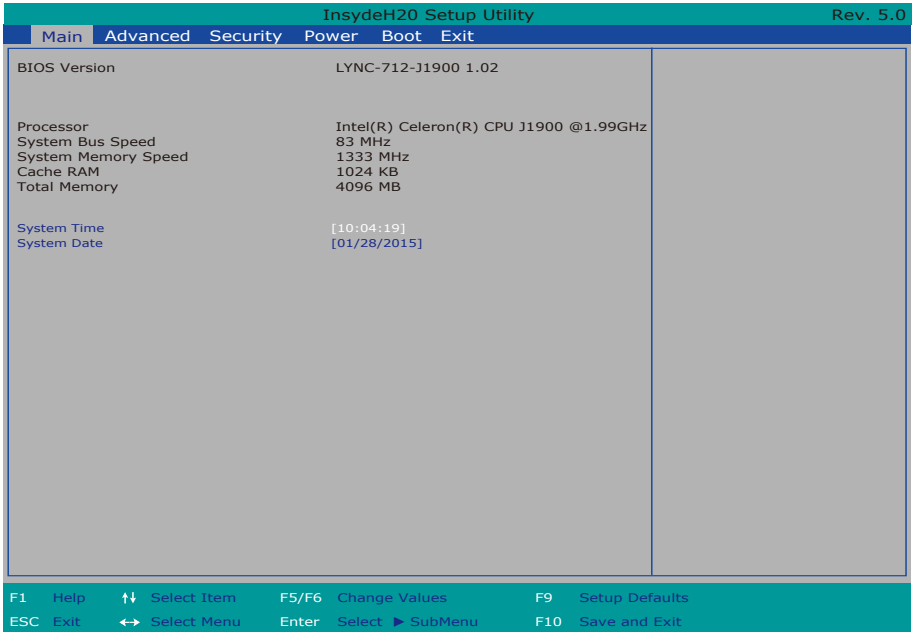

The BIOS featured menus are:

Menu	Description
Main	See 5.1. Main on page 48 .
Advanced	See 5.2. Advanced on page 49 .
Security	See 5.3. Security on page 54 .
Power	See 5.4. Power on page 55 .
Boot	See 5.5. Boot on page 56 .
Exit	See 5.6. Exit on page 57 .

Key Commands

The BIOS Setup utility relies on a keyboard to receive user's instructions. Hit the following keys to navigate within the utility and configure the utility.

Keystroke	Function
← →	Moves left/right between the top menus.
↓ ↑	Moves up/down between highlight items.
Enter	Selects an highlighted item/field.
Esc	<ul style="list-style-type: none"> ▶ On the top menus: Use Esc to quit the utility without saving changes to CMOS. (The screen will prompt a message asking you to select OK or Cancel to exit discarding changes. ▶ On the submenus: Use Esc to quit current screen and return to the top menu.
F5	Increases current value to the next higher value or switches between available options.
F6	Decreases current value to the next lower value or switches between available options.
F1	Opens the Help of the BIOS Setup utility.
F9	Restore the Setup Default (The screen then prompts a message asking you to select OK or Cancel to restore to default.)
F10	Exits the utility saving the changes that have been made. (The screen then prompts a message asking you to select OK or Cancel to exit saving changes.)

Note: Pay attention to the “WARNING” that shows at the left pane onscreen when making any change to the BIOS settings.

This BIOS Setup utility is updated from time to time to improve system performance and hence the screenshots hereinafter may not fully comply with what you actually have onscreen.

5.1. Main

The **Main** menu features the settings of **System Date** and **System Time** and displays some BIOS info and system info.

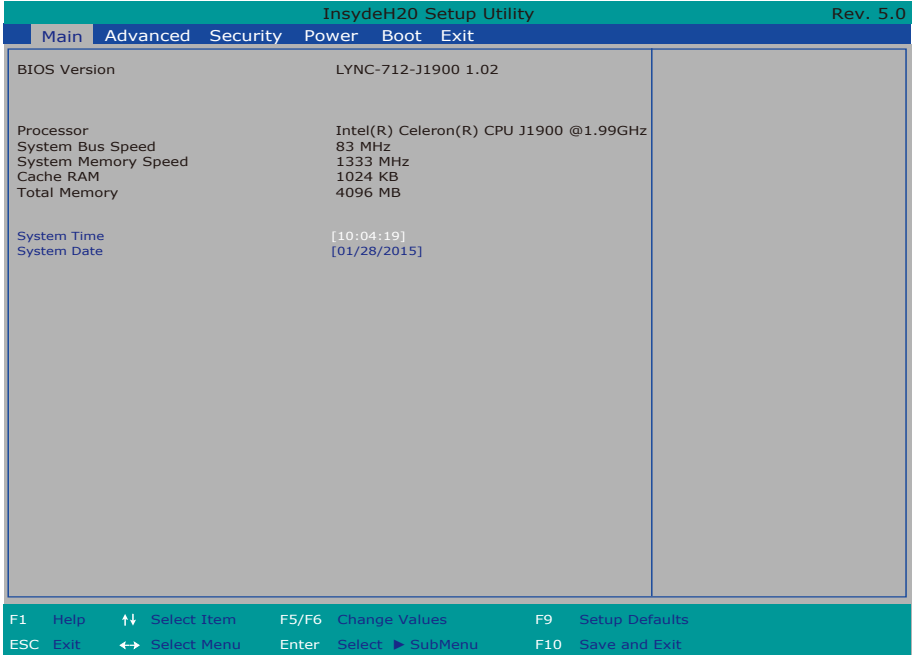

The BIOS info displayed are:

Info	Description
BIOS Version	Delivers the computer's BIOS version.
Processor Type	CPU and System BUS Information
RAM info	System Memory Speed, Cache RAM, Total Memory.

The featured settings are:

Setting	Description
System Time	Sets system time.
System Date	Sets system date.

5.2. Advanced

Access the **Advanced** menu to manage the computer's system configuration including the Super IO chip.

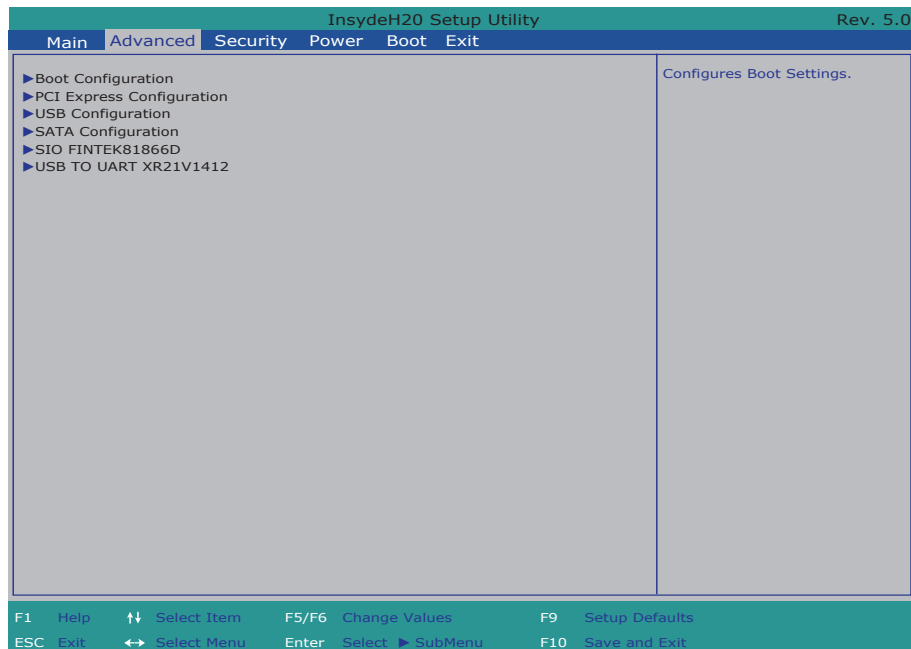

The featured settings and submenus are:

Setting	Description
Boot Configuration	See 5.2.1. Boot Configuration on page 50 .
PCI Express Configuration	See 5.2.2. PCI Express Configuration on page 50 .
USB Configuration	See 5.2.3. USB Configuration on page 50 .
Miscellaneous Configuration	See 5.2.4. SATA Configuration on page 51 .
SATA Configuration	See 5.2.5. SIO FINTEK81866D on page 51 .
SIO Fintek 81216	See 5.2.6. USB TO UART XR21V1412 on page 51 .

5.2.1. Boot Configuration

Setting	Description
Numlock	Select Power-on state for Num lock

5.2.2. PCI Express Configuration

Configures PCI Express by the following settings:

Setting	Description
PCI Express Root Port 1/2/3/4	<ul style="list-style-type: none"> ▶ PCI Express Root Port Enables/disables this PCIe port. ▶ PCIe Port 1/2/3/4 Speed Options are: Auto, Gen 1, Gen 2 Auto is the default. ▶ PCIe Port 1/2/3/4 ASPM Options are: Disable : disables ASPM L0s : force all links to L0s state L1 : force all links to L1 state L0sL1 : force all links to L0s+L1 state Auto : BIOS auto configure

5.2.3. USB Configuration

Select this submenu to view the status of the USB ports and configure USB features.

The featured settings are:

Setting	Description
XHCI Pre-Boot Mode Support	Enables/Disables XHCI Pre-Boot mode support
xHCI Mode	Set the mode of operation of xHCI controller Options are Disabled/Enabled/Auto/Smart Auto(default)
XCHI Controller	Enables/Disables XHCI controller
USB2 Link Power Management	Enables/Disables USB2 Link Power Management.
XCHI Streams	Enables/Disables XHCI Stream
USB RMH Mode	Enables/Disables PCH USB Rate Matching Hubs Mode
USB ECHI debug	Enables/Disables USB ECHI debug capability
USB Per-Port Control	Enables/Disables USB Per-port control

5.2.4. SATA Configuration

Select this submenu to configure the SATA controller.

Setting	Description
SATA Controller(s)	Enables/disables the present SATA controller. ▶ Enabled is the default.
Chipset SATA Mode	Configures how to run the SATA drives. ▶ Options available are AHCI (default) and IDE .
Serial ATA Port 0	Delivers the SATA port Media information
Serial ATA Port 1	

5.2.5. SIO FINTEK81866D

This submenu configures the computer's Super IO chip, FINTEK81866D, for the serial port A,B.

Setting	Description
Power loss mode	Set the state of Power Loss mode Options are: Always On (default) / Always Off
Serial Port A, B	Enable (default) or Disable Serial Port (COM)
COM Port Type	Set the mode of Serial port. Options: RS232 (default) RS485

5.2.6. USB TO UART XR21V1412

Setting	Description
Serial Port C, D	COM Port Type Set the mode of Serial port. Options: RS232 (default) RS485

Note. To configure COM 3&4 to RS-485, you need to set the COM port type to RS485 in BIOS and configure the port settings in the device manager in Windows OS. Please follow the steps as below to setup.

5.2.6.1 COM3&4 RS-485 Windows configuration

After set the COM port type to RS-485, reboot to enter the OS.
Don't forget to install the USB to UART driver first.

1. Go to Computer → right-click on Computer to open the menu and click Property.
2. Click the **Device Manager** to open it

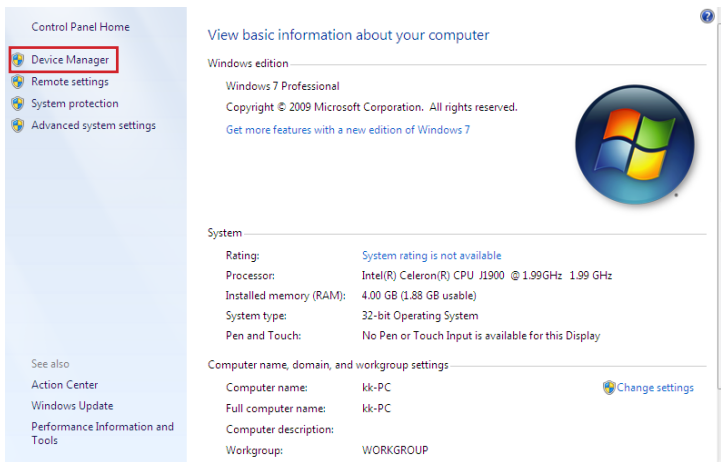

3. Click Ports (COM & LPT) to open the list.



- Right-click on the XR21V1412 USB UART Ch A or B (COM3 or COM4) to open the menu and click and click Property.
- Select the Port Settings tab and check the RS-485 to enable it.

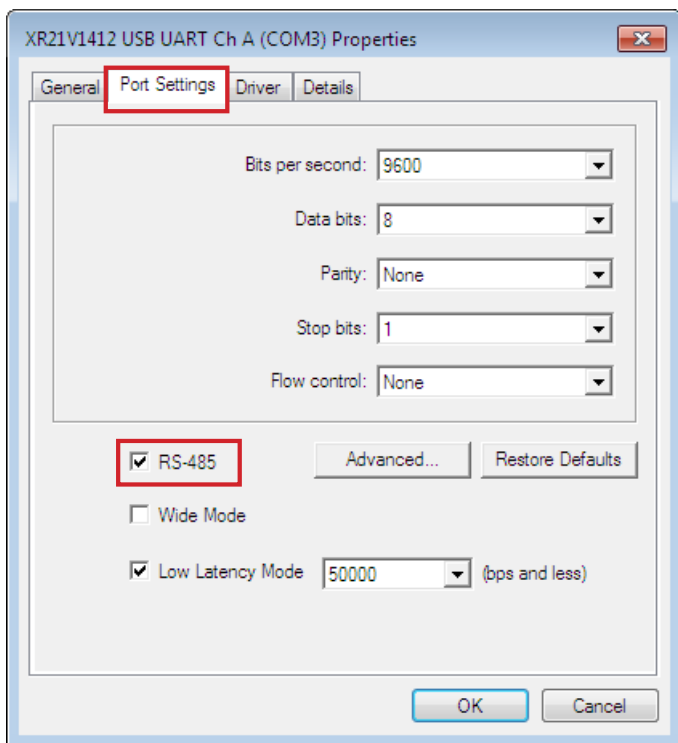

- Reboot the PC to enable the setting.

5.3. Security

The **Security** menu sets up the password for the system’s supervisor account. Once the supervisor password is set up, this BIOS Setup utility is limited to access and will ask for the password each time any access is attempted.

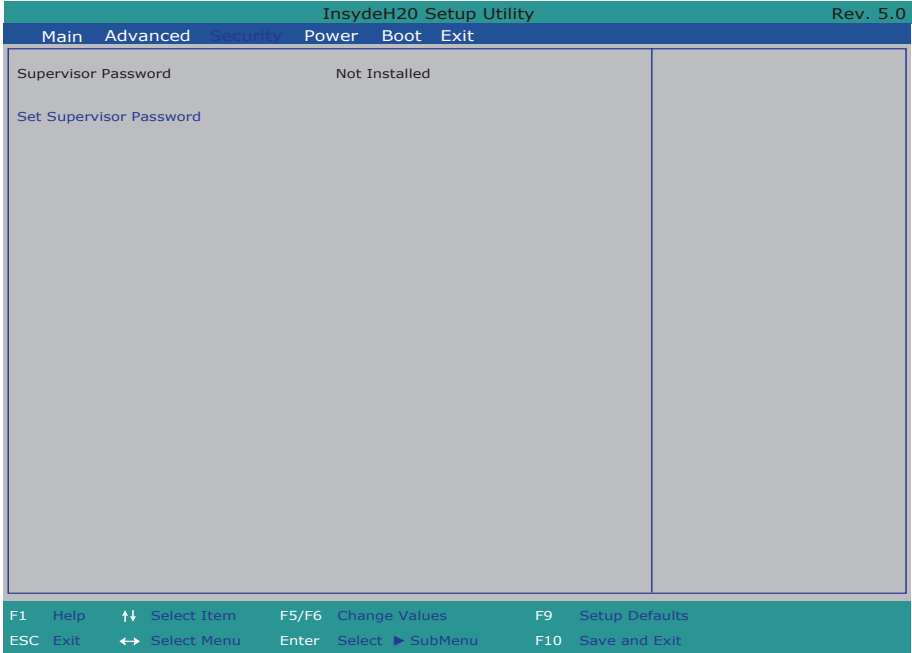

The featured setting is:

Setting	Description
Set Supervisor Password	<p>To set up an administrator password:</p> <ol style="list-style-type: none"> 1. Select Set Administrator Password. An Set Administrator Password dialog then pops up onscreen. 2. Enter your desired password that is no less than 3 characters and no more than 20 characters. 3. Hit [Enter] key to submit.

5.4. Power

The Power menu sets up the power option of system

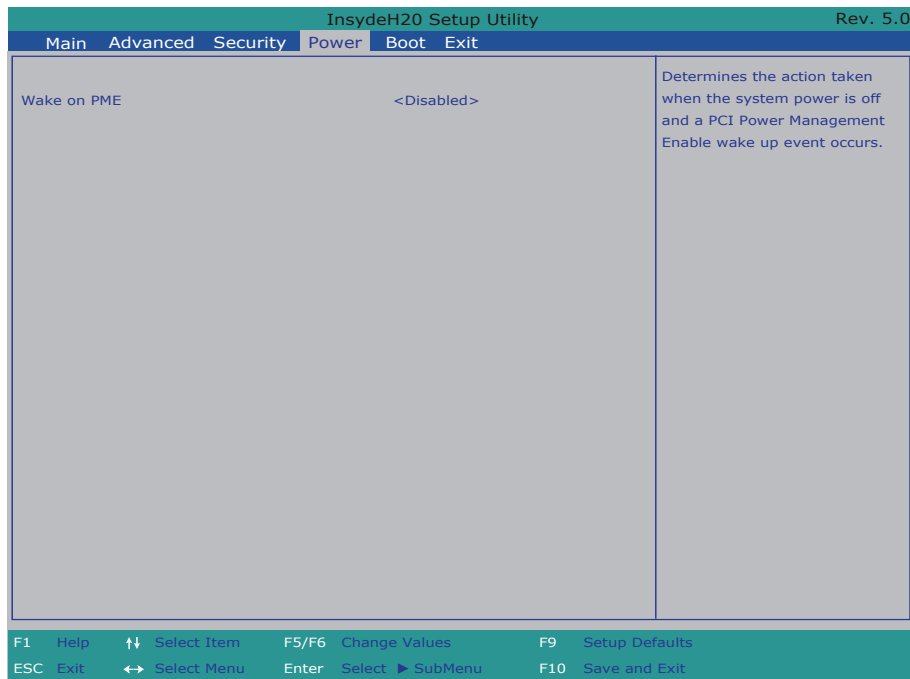

Setting	Description
Wake on PME	Enables or disables Wake on PME. Determines the action taken when the system power is off and a PCI Power Management Enable wake up event occurs.

5.5. Boot

The **Boot** menu configures how to boot up the system such as the configuration of boot device priority.



The featured settings are:

Setting	Description
Quiet Boot	Enables or disables booting in text mode.
Network Stack	Enables or disables UEFI network stack. Disabled is the default.
PXE Boot capability	Set the PXE boot capability Options are Disabled / UEFI: IPv4 / Legacy Disabled is the default.
APCI Selection	Select boot to Acpi 3.0/Acpi 1.0B Options are Acpi 1.0B/Acpi 3.0/Acpi 4.0/Acpi 5.0
Timeout	Set the waiting seconds before booting the default boot selection

5.6. Exit

The **Exit** menu features a handful of commands to launch actions from the BIOS Setup utility regarding saving changes, quitting the utility and recovering defaults.

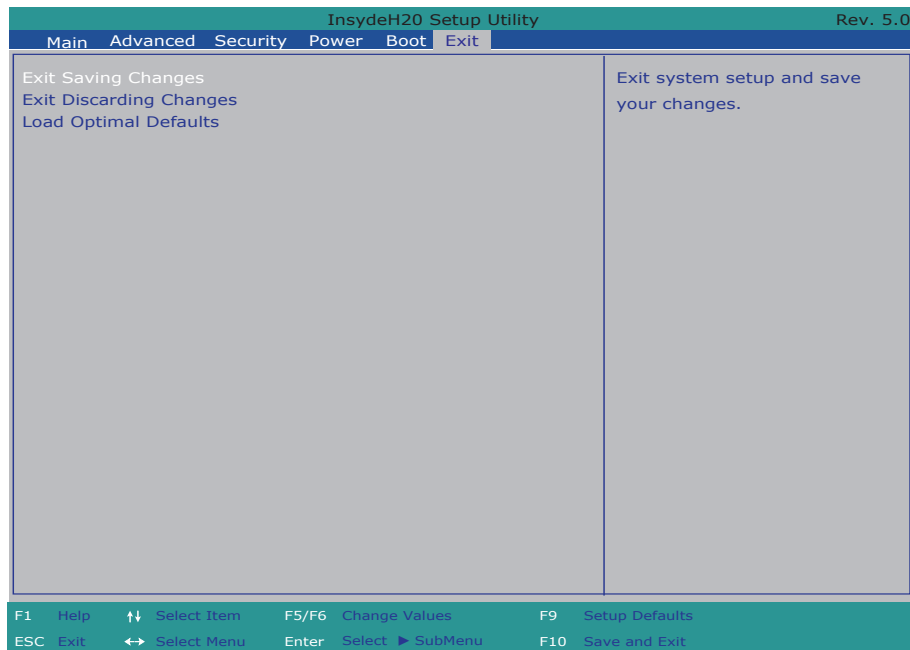

The features settings are:

Setting	Description
Exit Saving Changes	Exit system setup after saving the changes. ▶ Enter the item and then a dialog box pops up: Exit Saving Changes?
Exit Discarding Changes	Exit system setup without saving any changes. ▶ Enter the item and then a dialog box pops up: Exit Discarding Changes?
Load Optimal Defaults	Restore/Load Default values for all the setup options. ▶ Enter the item and then a dialog box pops up: Load Optimized Defaults?

This page is intentionally left blank.

Appendices

Appendix A: WIFI-AT2350 Hardware Installation

To use Wi-Fi, hardware-wise the computer needs a Wi-Fi module installed, and software-wise the computer needs the device driver and an application program. This appendix will guide you to install the Wi-Fi module WIFI-AT2350. (To have a copy of the device driver, please contact ARBOR customer service by the contact info described in [Technical Support](#) on page [vi](#).)

A.1. Install WIFI-AT2350

1. Loosen and remove the 8 screws from the computer's rear panel. Then, loosen and remove the 4 screws from each of the left and right panel of the computer.

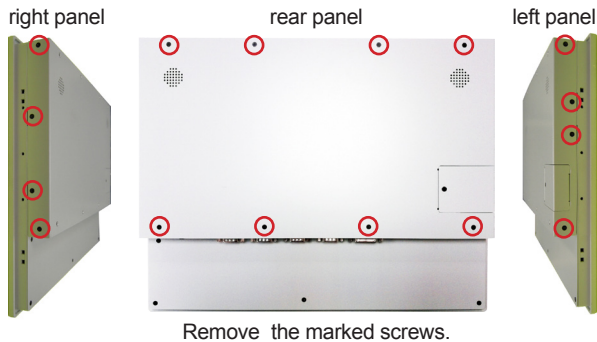

2. Dismount the rear cover from the computer. The inside of the computer comes to view.

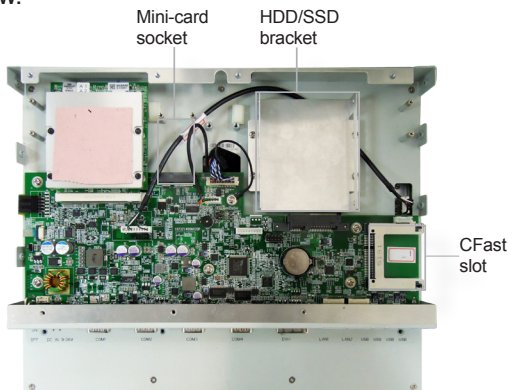

3. Prepare the WIFI-AT2350 Wi-Fi module kit. The module is a half-size module of PCI Express Mini-card form factor, with two U.FL connectors, one is “MAIN”, and the other is “AUX”.

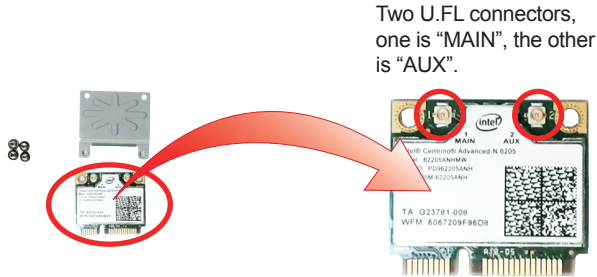

4. In order to make the half-size Wi-Fi module compatible with the Mini-card socket, extend the WiFi module with a “mini half bracket”. Join them together by using two screws.



Position the WiFi module and the “mini half bracket” exactly as shown.



Join the WiFi module and the “mini half bracket” by using two screws.

5. Plug the WIFI-AT2350 into the Mini-card socket by a slanted angle. Fully plug the module, and note the notch on the Wi-Fi module should meet the break on the connector.

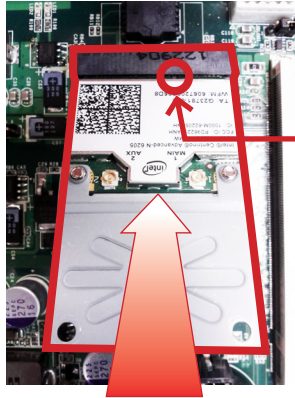

The notch on the Wi-Fi module should meet the break on the connector.

6. Press down the module and fix the module in place using two screws.



7. Tear off the tape from one of the RF cables.

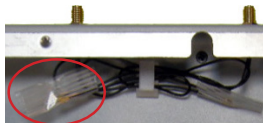

8. Connect the RF antenna's MHF connector to the Wi-Fi module's "MAIN" connector.

Connect the RF antenna's MHF connector to the Wi-Fi module's "MAIN" connector



9. Restore the rear panel to the computer. Have an external antenna. Screw and tightly fasten the antenna to the SMA connector. Swivel the antenna to an angle of best signals.

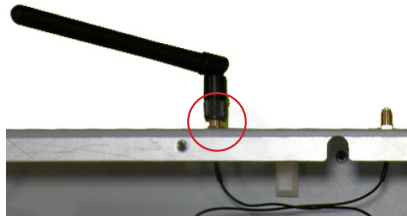

Appendix B: PenMount Utilities

B.1. PenMount Control Panel

After everything is installed properly, there will be a touch screen application named **PenMount Control Panel** in **All Programs**. Execute this application.

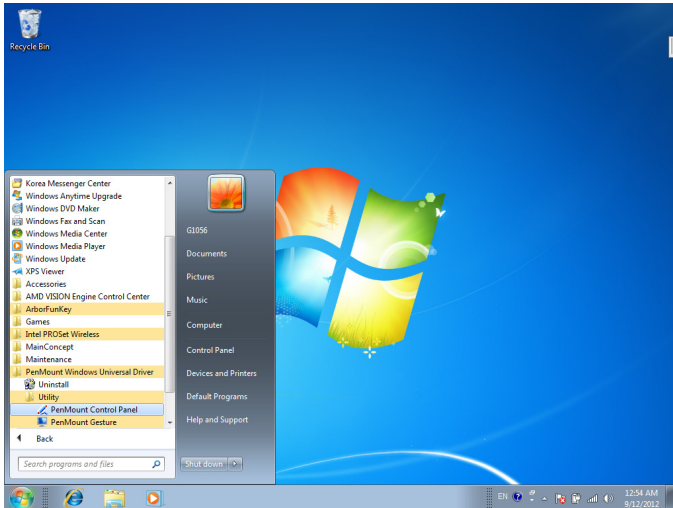

1. The program consists of 3 tabs. The left one is **Device**, in it, you can find how many devices are detected in your system. Select one device icon and tap **Configure**, or double tap the device icon for touch screen calibration.

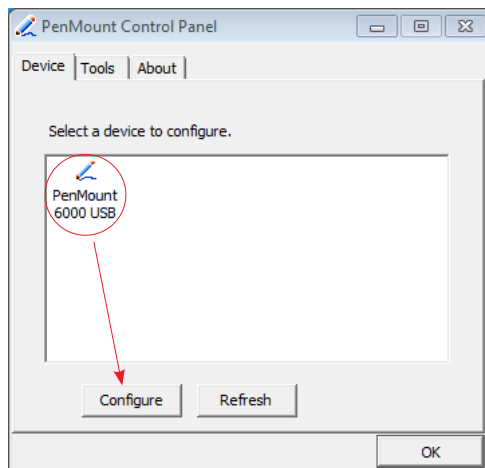

2. And then another window with **Calibrate** tab will jump out.

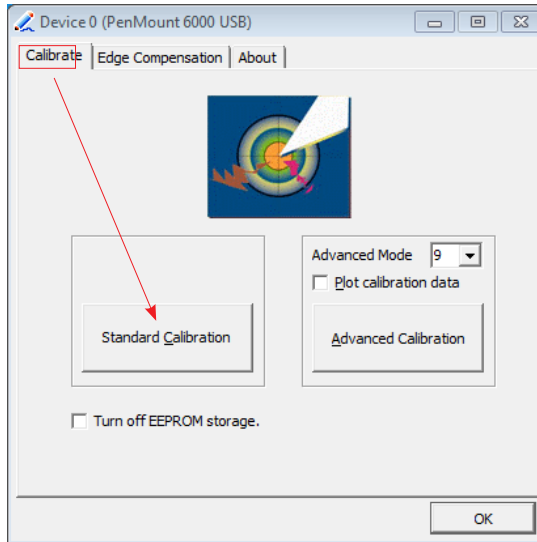

Device Calibration Dialog

a. The Calibrate Tab

This function offers two ways to calibrate your touch screen. ‘**Standard Calibration**’ adjusts most touch screens while ‘**Advanced Calibration**’ adjusts aging touch screens.

a.1 Standard Calibration

The Standard Calibration function lets you match the touch screen to your display so that the point you touch is accurately tracked on screen. Standard Calibration only requires four points for calibration and one point for confirmation. Under normal circumstance, Standard Calibration is all you need to perform an accurate calibration.

- i. Please tap the Standard Calibration button to start calibration procedures.
- ii. After that, the 1st crosshair will appear on white screen. Use your finger or stylus to touch the red center and hold down until the screen shows the message - “Lift off to proceed”.
- iii. The 2nd crosshair follows immediately. Do the process again. After the fifth red point calibration is complete, the program will jump out automatically, or you may press ESC key to quit it during calibration process. Alternatively, doing nothing for a while equates to pressing ESC.

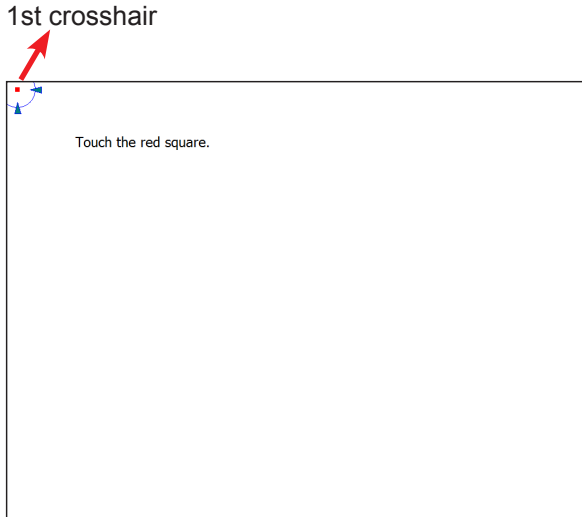

a.2 Advanced Calibration

The Advanced Calibration function improves the accuracy of calibration by using more involved engineering calculations. Use this function only if you have tried the Standard Calibration and there is still a discrepancy in the way the touch screen maps to the display. You can choose 9, 16 or 25 points to calibrate, though we suggest that you first try 9 points, if it is still not tracking well then try 16 or 25 points. The more points you use for calibration, the greater the accuracy is. Errors in calibration may occur due to viewing angle, or individual skill, and there may be little difference in using 16 or 25 points. Note that a stylus is recommended for most accurate results.

Plot Calibration Data

Check this function to have touch panel linearity comparison graph appear when you finish Advanced Calibration. The black lines reflect the ideal linearity assumed by PenMount's application program while the blue lines show the approximate linearity calculated by PenMount's application program as the result of user's execution of Advance Calibration.

Turn off EEPROM storage

Tick this function to disable the write-in of calibration data in Controller.

Please tap the Advanced Calibration button to start calibration procedures and do the rest as explained in Standard Calibration.

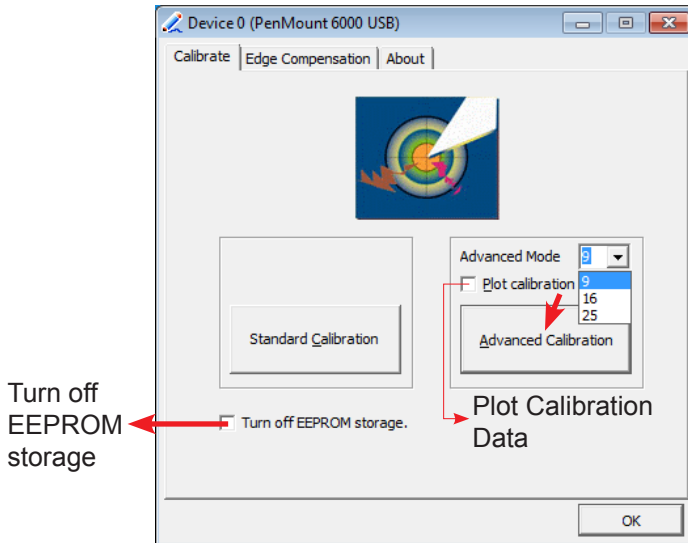

Turn off EEPROM storage

b. The Edge Compensation Tab

Under the same level where you calibrate your screen, you may find the tab. This tab is the edge compensation settings for the advanced calibration. You can adjust the settings from 0 to 30 for accommodating the difference of each touch panel.

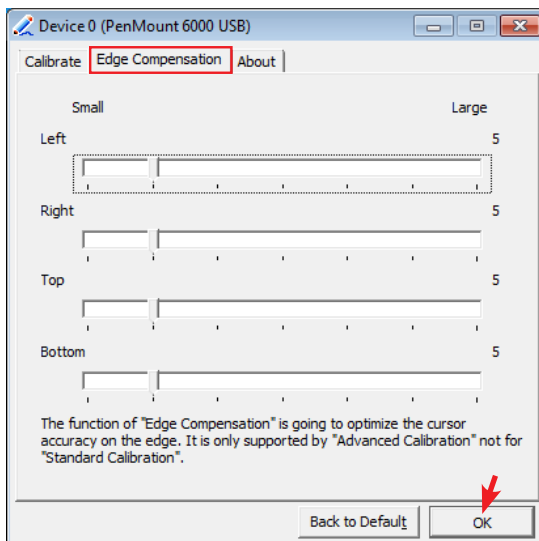

3. Press **OK** to close former window and back to upper level. As mentioned before, the program consists of 3 tabs, and the central one is **Tool**, switch to it and click **Draw** to test PenMount touch screen operation.

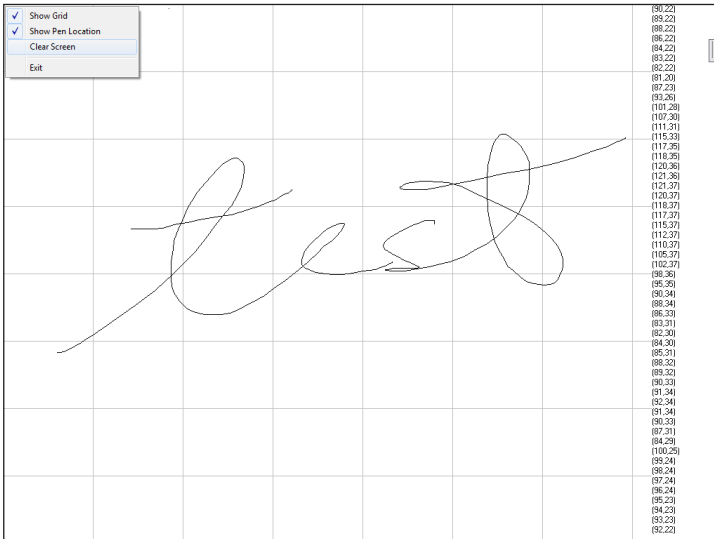
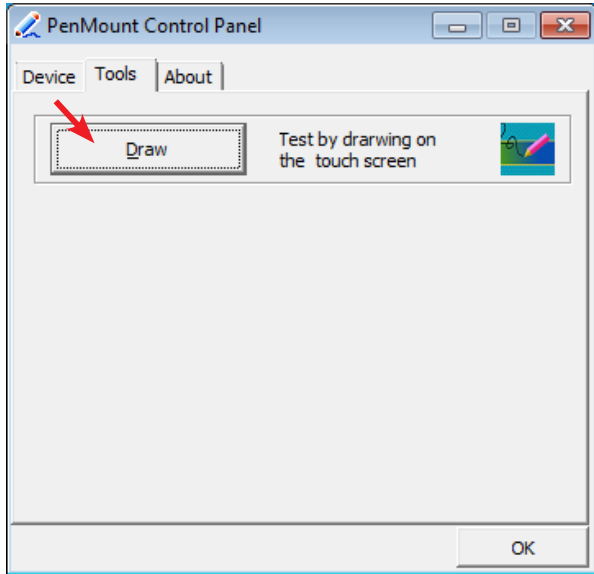

B.2. PenMount Gesture

1. Now that this tablet PC supports touchscreen function, you may take advantage of that to set hotkey or do other settings. Single-click a small icon like a monitor in system tray. If it's absent, you can recall it from **All Programs**. The default setting is inactive, so you need to click "Gesture Setting" to start the program.

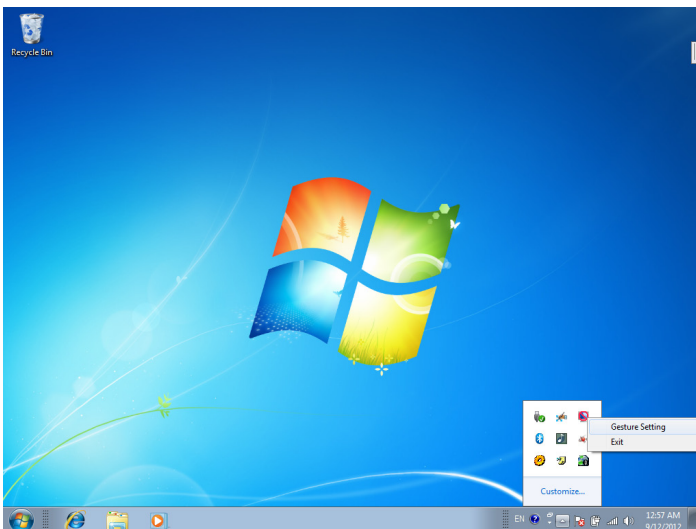
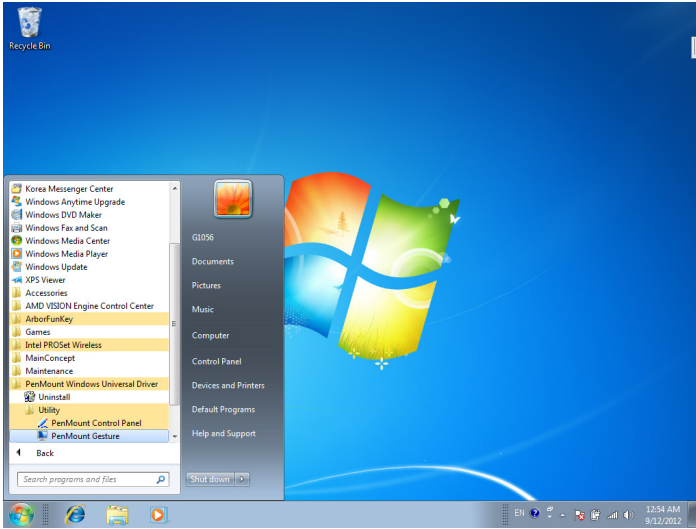

2. Check “Enable” and click the upward arrow in red square. You may also disable gesture function by canceling “Enable” box.

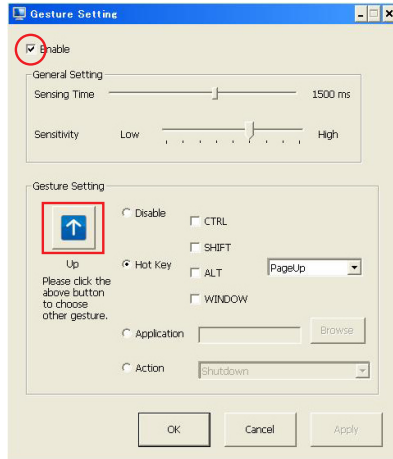

3. And then another **Gesture Select** window will pop up. Each mark in this menu represents your gesture on screen. For example, the upward arrow indicates that you move your finger across the touch screen from bottom to top. The rest are similar. You may use your gesture applied on the touchscreen to do further configuration. Select a gesture you would like to define.

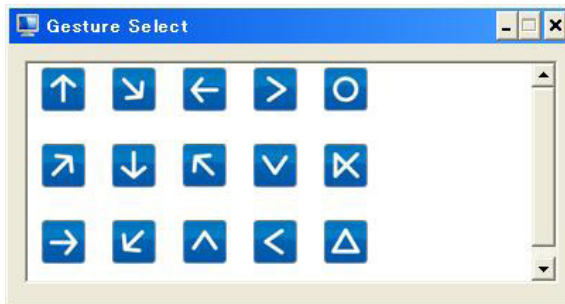

4. Then again, choose **Hot Key**, **Action** or **Application** to set each gesture's corresponding function. You may disable respective gesture, too. And remember to press **Apply** after all.

