



NexAIoT Co., Ltd.

**IoT Automation Solutions Business Group**

**Industrial Automation System**

**CMC300-Fxx Series**

User Manual

# CONTENTS

## Preface

Copyright .....	iv
Disclaimer .....	iv
Acknowledgements .....	iv
Regulatory Compliance Statements .....	iv
Declaration of Conformity .....	iv
RoHS Compliance .....	v
Warranty and RMA .....	vi
Safety Information .....	viii
Installation Recommendations .....	viii
Safety Precautions .....	ix
Technical Support and Assistance .....	x
Conventions Used in this Manual .....	x
Global Service Contact Information .....	xi
Package Contents .....	xiii
Ordering Information .....	xiv

## Chapter 1: Product Introduction

Overview .....	1
Hardware Specifications .....	2
Knowing Your CMC300-Fxx Series .....	4
Mechanical Dimensions .....	5
CMC300-F2x .....	5
CMC300-F0x .....	6

## Chapter 2: Jumpers and Connectors

Before You Begin .....	7
Precautions .....	7
Jumper Settings .....	8
Locations of the Jumpers and Connectors for the Main Board .....	9
Jumpers .....	10
Clear CMOS .....	10
AT/ATX Power Mode Select .....	10
Connector Pin Definitions .....	11
External I/O Interfaces - Front Panel .....	11
LAN1 and USB 3.0 Ports .....	11
LAN2 and USB 2.0 Ports .....	12
DVI-D Connector .....	13
COM 1 Port .....	13
24V DC Power Input .....	14
Internal Connectors .....	15
Debug Port .....	15
Battery Connector .....	15
Audio HDA Pin Header .....	16
COM2 Connector .....	16
SATA Connector 1 .....	17
SATA Connector 2 .....	17
SATA Power Connector 1 .....	18
SATA Power Connector 2 .....	18



FAN Connector ..... 19  
Mini-PCIe Connector..... 20  
PCIe x8 Slot..... 21

### **Chapter 3: BIOS Setup**

About BIOS Setup ..... 22  
When to Configure the BIOS..... 22  
Default Configuration ..... 23  
Entering Setup ..... 23  
Legends ..... 23  
BIOS Setup Utility..... 25  
    Main ..... 25  
    Advanced ..... 26  
    Chipset..... 30  
    Security ..... 30  
    Boot..... 31  
    Save & Exit ..... 31

### **Appendix A: Power Consumption ..... 32**



# PREFACE

## Copyright

This publication, including all photographs, illustrations and software, is protected under international copyright laws, with all rights reserved. No part of this manual may be reproduced, copied, translated or transmitted in any form or by any means without the prior written consent from NexAloT Co., Ltd.

## Disclaimer

The information in this document is subject to change without prior notice and does not represent commitment from NexAloT Co., Ltd. However, users may update their knowledge of any product in use by constantly checking its manual posted on our website: <http://www.nexaiot.com>. NexAloT shall not be liable for direct, indirect, special, incidental, or consequential damages arising out of the use of any product, nor for any infringements upon the rights of third parties, which may result from such use. Any implied warranties of merchantability or fitness for any particular purpose is also disclaimed.

## Acknowledgements

The CMC300-Fxx series is a trademark of NexAloT Co., Ltd. All other product names mentioned herein are registered trademarks of their respective owners.

## Regulatory Compliance Statements

This section provides the FCC compliance statement for Class A devices and describes how to keep the system CE compliant.

## Declaration of Conformity

### FCC

This equipment has been tested and verified to comply with the limits for a Class A digital device, pursuant to Part 15 of FCC Rules. These limits are designed to provide reasonable protection against harmful interference when the equipment is operated in a commercial environment. This equipment generates, uses, and can radiate radio frequency energy and, if not installed and used in accordance with the instructions, may cause harmful interference to radio communications. Operation of this equipment in a residential area (domestic environment) is likely to cause harmful interference, in which case the user will be required to correct the interference (take adequate measures) at their own expense.

### CE

The product(s) described in this manual complies with all applicable European Union (CE) directives if it has a CE marking. For computer systems to remain CE compliant, only CE-compliant parts may be used. Maintaining CE compliance also requires proper cable and cabling techniques.

## RoHS Compliance



### NexAloT RoHS Environmental Policy and Status Update

NexAloT is a global citizen for building the digital infrastructure. We are committed to providing green products and services, which are compliant with European Union RoHS (Restriction on Use of Hazardous Substance in Electronic Equipment) directive 2011/65/EU, to be your trusted green partner and to protect our environment.

RoHS restricts the use of Lead (Pb) < 0.1% or 1,000ppm, Mercury (Hg) < 0.1% or 1,000ppm, Cadmium (Cd) < 0.01% or 100ppm, Hexavalent Chromium (Cr6+) < 0.1% or 1,000ppm, Polybrominated biphenyls (PBB) < 0.1% or 1,000ppm, and Polybrominated diphenyl Ethers (PBDE) < 0.1% or 1,000ppm.

In order to meet the RoHS compliant directives, NexAloT has established an engineering and manufacturing task force to implement the introduction of green products. The task force will ensure that we follow the standard NexAloT development procedure and that all the new RoHS components and new manufacturing processes maintain the highest industry quality levels for which NexAloT are renowned.

The model selection criteria will be based on market demand. Vendors and suppliers will ensure that all designed components will be RoHS compliant.

### How to recognize NexAloT RoHS Products?

For existing products where there are non-RoHS and RoHS versions, the suffix "(LF)" will be added to the compliant product name.

All new product models launched after January 2013 will be RoHS compliant. They will use the usual NexAloT naming convention.

## Warranty and RMA

### NexAloT Warranty Period

NexAloT manufactures products that are new or equivalent to new in accordance with industry standard. NexAloT warrants that products will be free from defect in material and workmanship for 2 years, beginning on the date of invoice by NexAloT.

### NexAloT Return Merchandise Authorization (RMA)

- Customers shall enclose the “NexAloT RMA Service Form” with the returned packages.
- Customers must collect all the information about the problems encountered and note anything abnormal or, print out any on-screen messages, and describe the problems on the “NexAloT RMA Service Form” for the RMA number apply process.
- Customers can send back the faulty products with or without accessories (manuals, cable, etc.) and any components from the card, such as CPU and RAM. If the components were suspected as part of the problems, please note clearly which components are included. Otherwise, NexAloT is not responsible for the devices/parts.
- Customers are responsible for the safe packaging of defective products, making sure it is durable enough to be resistant against further damage and deterioration during transportation. In case of damages occurred during transportation, the repair is treated as “Out of Warranty.”
- Any products returned by NexAloT to other locations besides the customers’ site will bear an extra charge and will be billed to the customer.

### Repair Service Charges for Out-of-Warranty Products

NexAloT will charge for out-of-warranty products in two categories, one is basic diagnostic fee and another is component (product) fee.

#### System Level

- Component fee: NexAloT will only charge for main components such as SMD chip, BGA chip, etc. Passive components will be repaired for free, ex: resistor, capacitor.
- Items will be replaced with NexAloT products if the original one cannot be repaired. Ex: motherboard, power supply, etc.
- Replace with 3rd party products if needed.
- If RMA goods can not be repaired, NexAloT will return it to the customer without any charge.

#### Board Level

- Component fee: NexAloT will only charge for main components, such as SMD chip, BGA chip, etc. Passive components will be repaired for free, ex: resistors, capacitors.
- If RMA goods can not be repaired, NexAloT will return it to the customer without any charge.

## Warnings

Read and adhere to all warnings, cautions, and notices in this guide and the documentation supplied with the chassis, power supply, and accessory modules. If the instructions for the chassis and power supply are inconsistent with these instructions or the instructions for accessory modules, contact the supplier to find out how you can ensure that your computer meets safety and regulatory requirements.

## Cautions

Electrostatic discharge (ESD) can damage system components. Do the described procedures only at an ESD workstation. If no such station is available, you can provide some ESD protection by wearing an antistatic wrist strap and attaching it to a metal part of the computer chassis.

## Safety Information

Before installing and using the device, note the following precautions:

- Read all instructions carefully.
- Do not place the unit on an unstable surface, cart, or stand.
- Follow all warnings and cautions in this manual.
- When replacing parts, ensure that your service technician uses parts specified by the manufacturer.
- Avoid using the system near water, in direct sunlight, or near a heating device.
- The load of the system unit does not solely rely for support from the rackmounts located on the sides. Firm support from the bottom is highly necessary in order to provide balance stability.
- The computer is provided with a battery-powered real-time clock circuit. There is a danger of explosion if battery is incorrectly replaced. Replace only with the same or equivalent type recommended by the manufacturer. Discard used batteries according to the manufacturer's instructions.

## Installation Recommendations

Ensure you have a stable, clean working environment. Dust and dirt can get into components and cause a malfunction. Use containers to keep small components separated.

Adequate lighting and proper tools can prevent you from accidentally damaging the internal components. Most of the procedures that follow require only a few simple tools, including the following:

- A Philips screwdriver
- A flat-tipped screwdriver
- A grounding strap
- An anti-static pad

Using your fingers can disconnect most of the connections. It is recommended that you do not use needle-nose pliers to disconnect connections as these can damage the soft metal or plastic parts of the connectors.



## Safety Precautions

1. Read these safety instructions carefully.
2. Keep this User Manual for later reference.
3. Disconnect this equipment from any AC outlet before cleaning. Use a damp cloth. Do not use liquid or spray detergents for cleaning.
4. For plug-in equipment, the power outlet socket must be located near the equipment and must be easily accessible.
5. Keep this equipment away from humidity.
6. Put this equipment on a stable surface during installation. Dropping it or letting it fall may cause damage.
7. The openings on the enclosure are for air convection to protect the equipment from overheating. **DO NOT COVER THE OPENINGS.**
8. Make sure the voltage of the power source is correct before connecting the equipment to the power outlet.
9. Place the power cord in a way so that people will not step on it. Do not place anything on top of the power cord. Use a power cord that has been approved for use with the product and that it matches the voltage and current marked on the product's electrical range label. The voltage and current rating of the cord must be greater than the voltage and current rating marked on the product.
10. All cautions and warnings on the equipment should be noted.
11. If the equipment is not used for a long time, disconnect it from the power source to avoid damage by transient overvoltage.
12. Never pour any liquid into an opening. This may cause fire or electrical shock.
13. Never open the equipment. For safety reasons, the equipment should be opened only by qualified service personnel.
14. If one of the following situations arises, get the equipment checked by service personnel:
  - a. The power cord or plug is damaged.
  - b. Liquid has penetrated into the equipment.
  - c. The equipment has been exposed to moisture.
  - d. The equipment does not work well, or you cannot get it to work according to the user's manual.
  - e. The equipment has been dropped and damaged.
  - f. The equipment has obvious signs of breakage.
15. Do not place heavy objects on the equipment.
16. The unit uses a three-wire ground cable which is equipped with a third pin to ground the unit and prevent electric shock. Do not defeat the purpose of this pin. If your outlet does not support this kind of plug, contact your electrician to replace your obsolete outlet.
17. **CAUTION: DANGER OF EXPLOSION IF BATTERY IS INCORRECTLY REPLACED. REPLACE ONLY WITH THE SAME OR EQUIVALENT TYPE RECOMMENDED BY THE MANUFACTURER. DISCARD USED BATTERIES ACCORDING TO THE MANUFACTURER'S INSTRUCTIONS.**

## Technical Support and Assistance

1. For the most updated information of NexAloT products, visit NexAloT's website at [www.nexaiot.com](http://www.nexaiot.com).
2. For technical issues that require contacting our technical support team or sales representative, please have the following information ready before calling:
  - Product name and serial number
  - Detailed information of the peripheral devices
  - Detailed information of the installed software (operating system, version, application software, etc.)
  - A complete description of the problem
  - The exact wordings of the error messages

### Warning!

1. Handling the unit: carry the unit with both hands and handle it with care.
2. Maintenance: to keep the unit clean, use only approved cleaning products or clean with a dry cloth.

## Conventions Used in this Manual



### Warning:

Information about certain situations, which if not observed, can cause personal injury. This will prevent injury to yourself when performing a task.



### Caution:

Information to avoid damaging components or losing data.



### Note:

Provides additional information to complete a task easily.

## Global Service Contact Information

### Headquarters

#### NEXCOM International Co., Ltd.

9F, No. 920, Chung-Cheng Rd.,  
Zhonghe District, New Taipei City, 23586,  
Taiwan, R.O.C.  
Tel: +886-2-8226-7786  
Fax: +886-2-8226-7782  
www.nexcom.com

### Asia

#### Taiwan

#### NexAIoT Headquarters

#### Industry 4.0 and Cloud Services

13F, No.916, Zhongzheng Rd.,  
Zhonghe District, New Taipei City,  
23586, Taiwan, R.O.C.  
Tel: +886-2-8226-7796  
Fax: +886-2-8226-7926  
Email: sales@nexaiot.com  
www.nexaiot.com

#### NexAIoT Co., Ltd.

#### Taichung Office

16F, No.250, Sec. 2, Chongde Rd.,  
Beitun District,  
Taichung City, 406, Taiwan, R.O.C.  
Tel: +886-4-2249-1179  
Fax: +886-4-2249-1172  
Email: sales@nexaiot.com  
www.nexaiot.com

#### NexCOBOT Taiwan Co., Ltd.

13F, No.916, Chung-Cheng Rd.,  
Zhonghe District,  
New Taipei City, 23586, Taiwan, R.O.C.  
Tel: +886-2-8226-7786  
Fax: +886-2-8226-7926  
Email: sales@nexcobot.com  
www.nexcobot.com

#### GreenBase Technology Corp.

13F, No.922, Chung-Cheng Rd.,  
Zhonghe District,  
New Taipei City, 23586, Taiwan, R.O.C.  
Tel: +886-2-8226-7786  
Fax: +886-2-8226-7900  
Email: sales@nexcom.com.tw  
www.nexcom.com.tw

#### EMBUX Technology Co., Ltd.

13F, No.916, Chung-Cheng Rd.,  
Zhonghe District,  
New Taipei City, 23586, Taiwan, R.O.C.  
Tel: +886-2-8226-7786  
Fax: +886-2-8226-7782  
Email: sales@nexcom.com.tw  
www.nexcom.com.tw

#### TMR Technology Corp.

13F, No.916, Chung-Cheng Rd.,  
Zhonghe District,  
New Taipei City, 23586, Taiwan, R.O.C.  
Tel: +886-2-8226-7786  
Fax: +886-2-8226-7782  
Email: sales@nexcom.com.tw  
www.nexcom.com.tw

### China

#### NEXSEC Incorporated

5F, No.4, No.7 Fengxian Middle Rd.,  
(Beike Industrial Park), Haidian District,  
Beijing, 100094, China  
Tel: +86-10-5704-2680  
Fax: +86-10-5704-2681  
Email: marketing@nexsec.cn  
www.nexsec.cn

#### NEXCOM Shanghai

No.4, 16 Building,  
Shanghai OMNI Tech & Science Park  
No. 1699, Douhui Rd.,  
Shanghai, 201108, China  
Tel: +86-21-5278-5868  
Fax: +86-21-3251-6358  
Email: sales@nexcom.cn  
www.nexcom.cn

## **NEXCOM Surveillance Technology Corp.**

5F, Building C, ZhenHan Industrial Zone,  
GanKeng Community, Buji Street,  
LongGang District,  
ShenZhen, 518112, China  
Tel: +86-755-8364-7768  
Fax: +86-755-8364-7738  
Email: steveyang@nexcom.com.tw  
www.nexcom.cn

## **NEXCOM United System Service**

Room 603/604, Huiyinmingzun Plaza Bldg. 1,  
No. 609, Yunlin East Rd.,  
Shanghai, 200062, China  
Tel: +86-21-5278-5868  
Fax: +86-21-3251-6358  
Email: renwang@nexcom.com.tw  
www.nexcom.cn

## **NEXGOL Chongqing**

1F, Building B4, Electronic 2nd Area,  
(Phoenix Lake Industrial Park), Yongchuan Dist.,  
Chongqing City, 402160, China  
Tel: +86-23-4960-9080  
Fax: +86-23-4966-5855  
Email: sales@nexgol.com.cn  
www.nexcobot.com/NexGOL

## **NexCOBOT China**

Room 501, Building 1, Haichuang Building,  
No.7 Qingyi Road, Guicheng Street,  
Nanhai District, Foshan City,  
Guangdong Province, 528314, China  
Tel: +86-757-8625-7118  
Email: sales@nexcobot.com  
www.nexcobot.com.cn

## **Beijing NexGemo Technology Co.,Ltd.**

5F, Gemotech Building, No.1, Development Rd.,  
Changping International Information Industry Base,  
Changping District,  
Beijing, 102206, China  
Tel: +86-10-8190-9328  
Fax: +86-10-8190-9456  
Email: sales@gemotech.cn  
www.nexgemo.cn

## **Japan**

### **NEXCOM Japan**

9F, Tamachi Hara Bldg.,  
4-11-5, Shiba Minato-ku,  
Tokyo, 108-0014, Japan  
Tel: +81-3-5419-7830  
Fax: +81-3-5419-7832  
Email: sales@nexcom-jp.com  
www.nexcom-jp.com

## **America**

### **USA NEXCOM USA**

46665 Fremont Blvd.,  
Fremont CA 94538, USA  
Tel: +1-510-656-2248  
Fax: +1-510-656-2158  
Email: sales@nexcom.com  
www.nexcomusa.com

## **Europe**

### **United Kingdom NEXCOM EUROPE**

10 Vincent Avenue,  
Crownhill Business Centre,  
Milton Keynes, Buckinghamshire  
MK8 0AB, United Kingdom  
Tel: +44-1908-267121  
Fax: +44-1908-262042  
Email: sales.uk@nexcom.eu  
www.nexcom.co.uk

## Package Contents

Before continuing, verify that the package you received is complete. Your package should have the item listed in the table below.

### Accessories

Item	Description	Qty
1	3-pin Terminal Connector	1
2	Panel Mount Kit	8

## Ordering Information

The following information below provides ordering information for CMC300-Fxx series.

### Barebone

- **CMC300-F03 (P/N: 10CM0030004X0)**  
Cabinet mount controller fanless PC with Intel® Core™ i5-9500TE  
2.2GHz
- **CMC300-F22 (P/N: 10CM0030001X0)**  
Cabinet mount controller fanless PC with Intel® Core™ i7-9700TE  
1.8GHz, and two PCIe x4 expansion slots
- **CMC300-F23 (P/N: 10CM0030002X0)**  
Cabinet mount controller fanless PC with Intel® Core™ i5-9500TE  
2.2GHz, and two PCIe x4 expansion slots

### Optional

- **DDR4 DRAM 16GB (P/N: 72BGM16G07H00)**
- **DDR4 DRAM 32GB (P/N: 72BGM32G02H00)**

# CHAPTER 1: PRODUCT INTRODUCTION

## Overview

**CMC300-F2x**



**CMC300-F0x**



## Key Features

- Fanless system design (CMC300-F2x)
- Fanless system design with slim form factor (CMC300-F0x)
- Intel® Xeon® E-2278GEL and 8th & 9th generation Intel® Core™ i7/i5/i3 LGA socket type processors
- 2 x Gigabit Ethernet
- 2 x USB 2.0, 2 x USB 3.0, 1 x COM RS232/422/485
- IP65 protection on the outside heatsink
- 1 x DVI-D display output
- 2 x DDR4 up to 64GB
- 1 x Mini-PCIe for storage device
- 2 x Easy-access 2.5" SSD trays
- Support power input 24 VDC

## Hardware Specifications

### CPU Support

- Support Intel® Xeon® E-2278GEL
- Support 8th & 9th generation Intel® Core™ i7/i5/i3 LGA socket type:
  - Intel® Core™ Core i3-8100T, i5-8500T, i7-8700T
  - Intel® Core™ Core i3-9100TE, i5-9500TE, i7-9700TE
- Support up to TDP 35W CPU

### PCH

- Intel® C246 PCH

### Main Memory

- 2 x DDR4 2400/2666 SO-DIMM sockets, support up to 64GB with non-ECC and un-buffered
- Support ECC with Intel® Xeon® processor

### I/O Interface Status LEDs

- Power
- SATA (SSD)

### I/O Interface - Front

- DC power input connector: 3-pin Phoenix Contact terminal blocks
- COM: 1 x RS232/422/485
- Display: 1 x DVI-D port
- Ethernet: 2 x RJ45
  - LAN: 1 x Intel® I219-LM PHY LAN and 1 x Intel® I210-IT Gigabit LAN
  - Ethernet interface: 10/100/1000 Mbps
  - Support wake up on LAN

- 2 x USB 2.0 ports
- 2 x USB 3.0 ports
- 2-pin remote power on/off
- 1 x Easy-access RTC battery socket

### Storage Device

- 2 x Easy-access 2.5" SSD trays
- 1 x Mini-PCIe slot for storage

### Expansion (CMC300-F2x Only)

- Two PCIe x4 expansion slots from PCIe x8 riser card

### Power Requirements

- DC power input:
  - Input voltage: 18VDC -5% to 24VDC +10%, 7.5A
  - Reverse polarity protection

### Environment

- Operating temperature:
  - 0°C to 55°C with natural convection
  - 0°C to 60°C with mild forced airflow
- Operating humidity support 10%~90% relative humidity, non-condensing
- Vibration protection w/ HDD condition:
  - Random: 0.5Grms @ 5~500 Hz, IEC60068-2-64
  - Sinusoidal: 0.5Grms @ 5~500 Hz, IEC60068-2-64



## Dimensions

### **CMC300-F2x**

- Dimension: 330mm x 275mm x 116.2mm
- Weight: 6kg

### **CMC300-F0x**

- Dimension: 330mm x 275mm x 62.7mm
- Weight: 5.7kg

## Construction

- Aluminum extrusion heat sink and iron nickel plating housing
- Back cover with reserved RAID card heatsink hole
- IP65 protection for the outside heatsink

## Certifications

- CE (EN61000-6-2/EN61000-6-4)
- FCC Class A

## OS Support List

- Windows 10 64-bit

## Knowing Your CMC300-Fxx Series

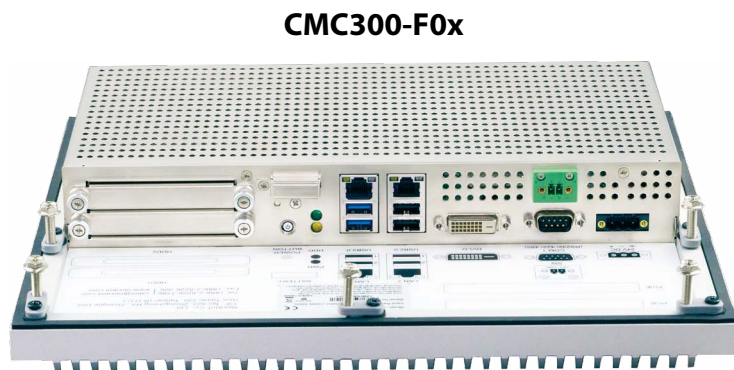
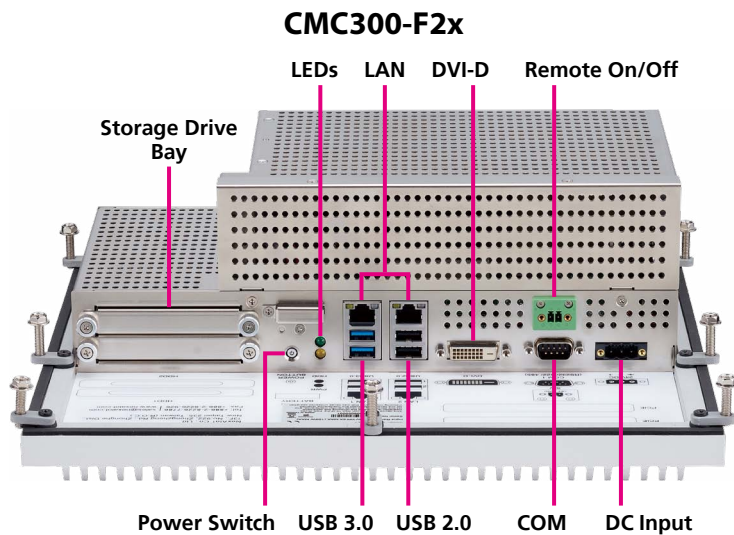

### 2.5" Storage Drive Bay

Two removable storage drive bays used to install 2.5" HDD/SSDs.

### Power Switch

Press to power-on or power-off the system.

### LED Indicators

Indicates the power status and storage drive activity of the system.

### LAN

Used to connect the system to a local area network.

### USB 3.0

USB 3.0 ports to connect the system with USB 3.0/2.0 devices.

### USB 2.0

USB 2.0 ports to connect the system with USB 2.0/1.1 devices.

### DVI-D

Used to connect a DVI-D interface display.

### Remote On/Off Switch (Default: No function; Optional: Please refer to page 19)

Used to connect a remote to power on/off the system.

### COM

DB9 port used to connect RS232/RS422/RS485 compatible devices.

### DC Input

Used to plug a DC power cord.

# Mechanical Dimensions

## CMC300-F2x

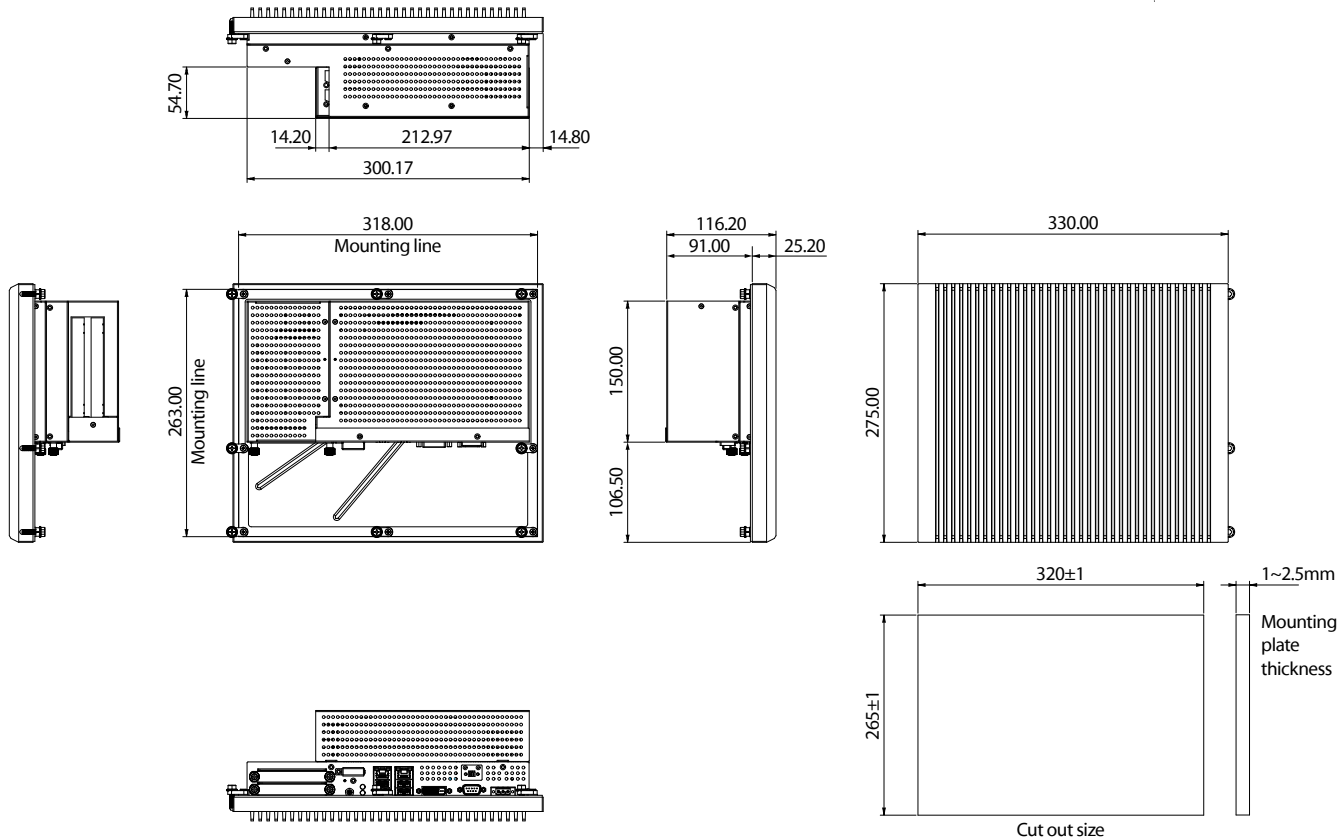

# CMC300-F0x

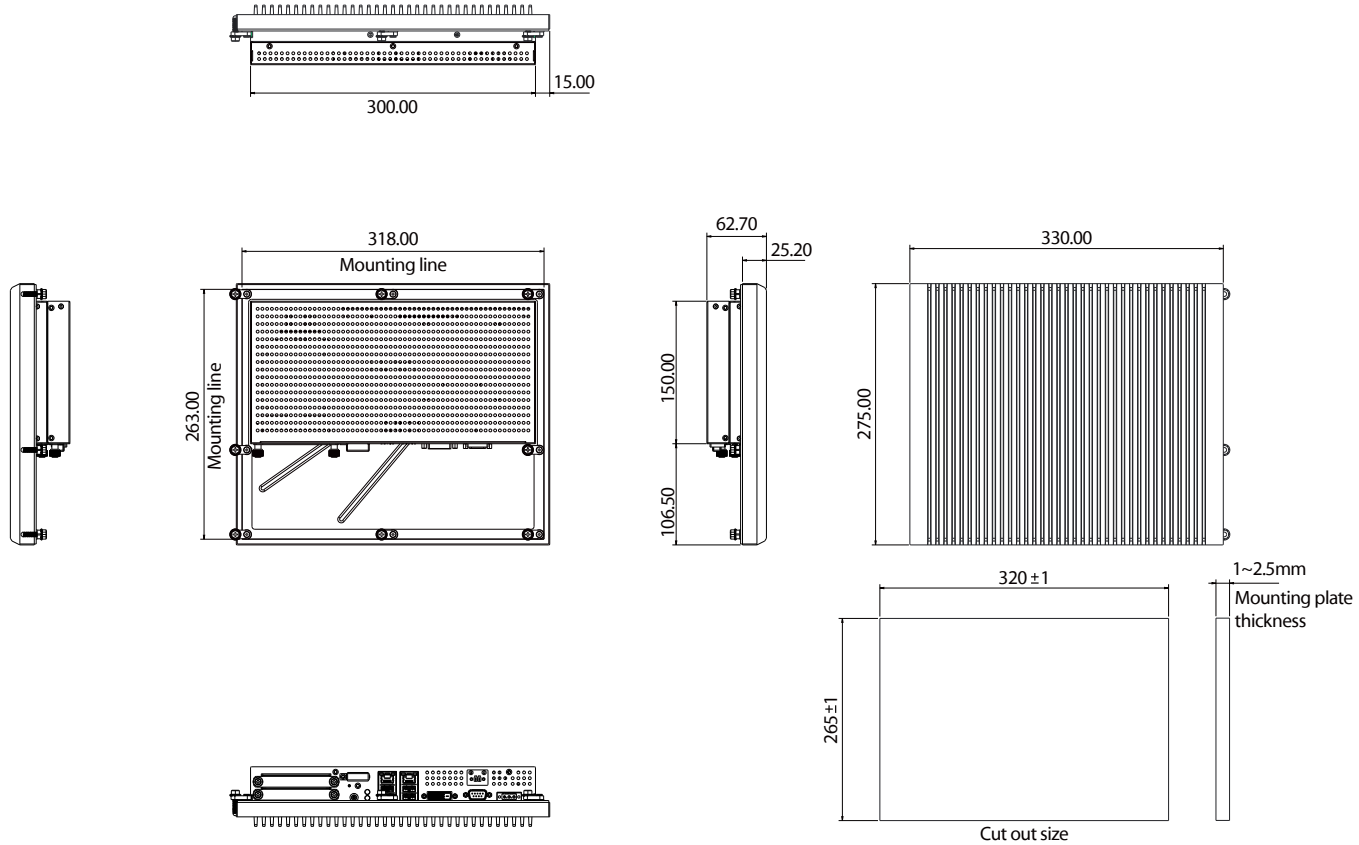

## CHAPTER 2: JUMPERS AND CONNECTORS

This chapter describes how to set the jumpers and connectors on the CMC300-Fxx series motherboard.

### Before You Begin

- Ensure you have a stable, clean working environment. Dust and dirt can get into components and cause a malfunction. Use containers to keep small components separated.
- Adequate lighting and proper tools can prevent you from accidentally damaging the internal components. Most of the procedures that follow require only a few simple tools, including the following:
  - A Philips screwdriver
  - A flat-tipped screwdriver
  - A set of jewelers screwdrivers
  - A grounding strap
  - An anti-static pad
- Using your fingers can disconnect most of the connections. It is recommended that you do not use needle-nosed pliers to disconnect connections as these can damage the soft metal or plastic parts of the connectors.
- Before working on internal components, make sure that the power is off. Ground yourself before touching any internal components, by touching a metal object. Static electricity can damage many of the electronic components. Humid environments tend to have less static electricity than

dry environments. A grounding strap is warranted whenever danger of static electricity exists.

### Precautions

Computer components and electronic circuit boards can be damaged by discharges of static electricity. Working on computers that are still connected to a power supply can be extremely dangerous.

Follow the guidelines below to avoid damage to your computer or yourself:

- Always disconnect the unit from the power outlet whenever you are working inside the case.
- If possible, wear a grounded wrist strap when you are working inside the computer case. Alternatively, discharge any static electricity by touching the bare metal chassis of the unit case, or the bare metal body of any other grounded appliance.
- Hold electronic circuit boards by the edges only. Do not touch the components on the board unless it is necessary to do so. Don't flex or stress the circuit board.
- Leave all components inside the static-proof packaging that they shipped with until they are ready for installation.
- Use correct screws and do not over tighten screws.

## Jumper Settings

A jumper is the simplest kind of electric switch. It consists of two metal pins and a cap. When setting the jumpers, ensure that the jumper caps are placed on the correct pins. When the jumper cap is placed on both pins, the jumper is short. If you remove the jumper cap, or place the jumper cap on just one pin, the jumper is open.

Refer to the illustrations below for examples of what the 2-pin and 3-pin jumpers look like when they are short (on) and open (off).

Two-Pin Jumpers: Open (Left) and Short (Right)

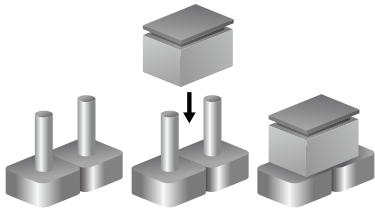

Three-Pin Jumpers: Pins 1 and 2 are Short

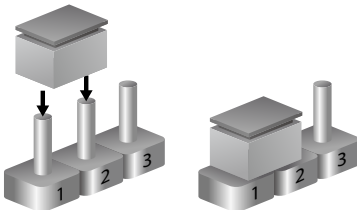

# Locations of the Jumpers and Connectors for the Main Board

The figure below is the top view of the main board used in the CMC300-Fxx Series. It shows the locations of the jumpers and connectors.

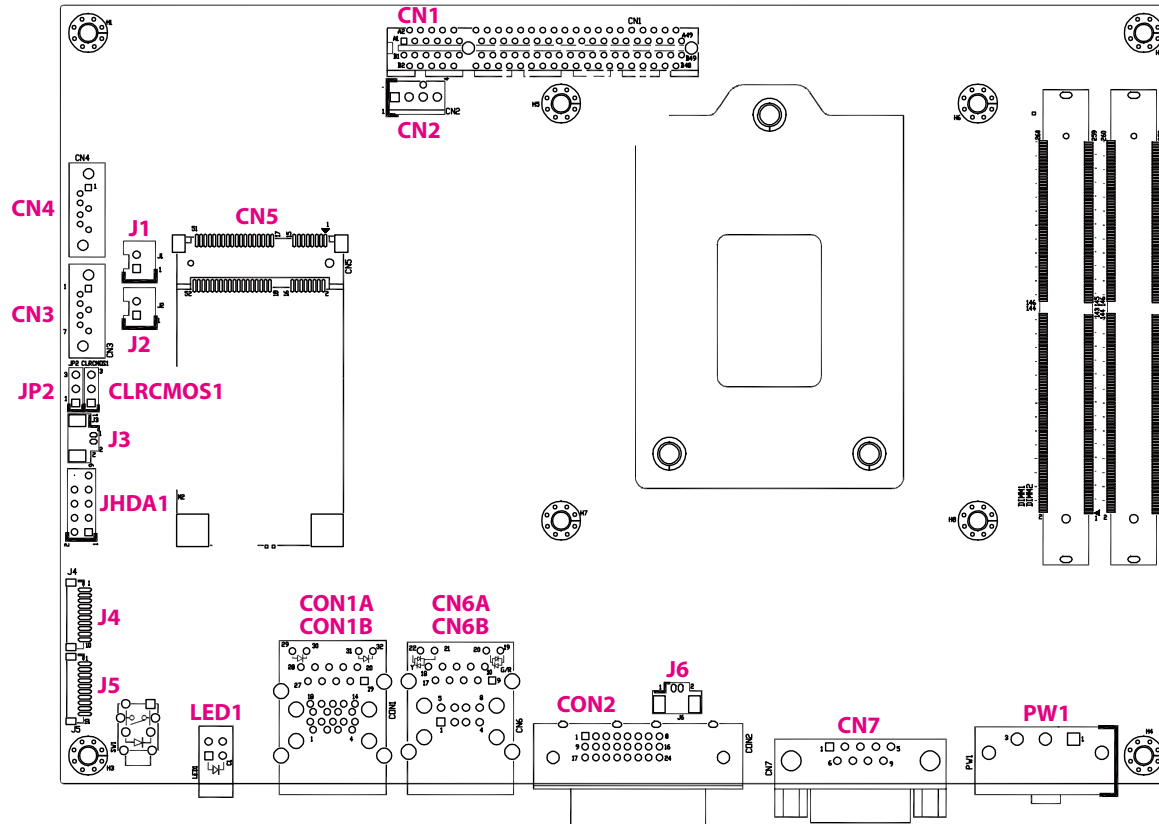

## Jumpers

### Clear CMOS

Connector type: 1x3 3-pin header, 2.54mm pitch  
Connector location: CLRCMOS1

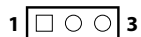

Pin	Settings
1-2 On	N/A
2-3 On	RTC Reset

1-2 On: default

### AT/ATX Power Mode Select

Connector type: 1x3 3-pin header, 2.54mm pitch  
Connector location: JP2

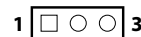

Pin	Settings
1-2 On	AT
2-3 On	ATX

2-3 On: default



## Connector Pin Definitions

### External I/O Interfaces - Front Panel

#### LAN1 and USB 3.0 Ports

Connector type: RJ45 port with LEDs and dual USB 3.0 ports

Connector location: CON1A (USB) and CON1B (LAN1)

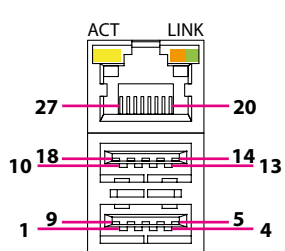

Act	Status
Flashing Yellow	Data activity
Off	No activity

Link	Status
Steady Green	1G network link
Steady Orange	100Mbps network link
Off	10Mbps or no link

#### USB

Pin	Definition	Pin	Definition
1	+5V	2	USB2_N
3	USB2_P	4	GND
5	USB3_RXN	6	USB3_RXP
7	GND	8	USB3_TXN
9	USB3_TXP	10	+5V
11	USB2_N	12	USB2_P
13	GND	14	USB3_RXN
15	USB3_RXP	16	GND
17	USB3_TXN	18	USB3_TXP

#### LAN1

Pin	Definition	Pin	Definition
19	+0V9_LAN	20	LAN_MDI0P
21	LAN_MDI0N	22	LAN_MDI1P
23	LAN_MDI1N	24	LAN_MDI2P
25	LAN_MDI2N	26	LAN_MDI3P
27	LAN_MDI3N	28	GND
LED1	+3VSB	LED2	LAN_LED_ACT#
LED3	LAN_LED_100#	LED4	LAN_LED_1G#

## LAN2 and USB 2.0 Ports

Connector type: RJ45 port with LEDs and dual USB 2.0 ports

Connector location: CN6A (USB) and CN6B (LAN2)

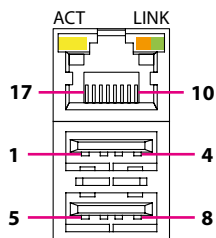

Act	Status
Flashing Yellow	Data activity
Off	No activity

Link	Status
Steady Green	1G network link
Steady Orange	100Mbps network link
Off	10Mbps or no link

### USB

Pin	Definition	Pin	Definition
1	+5V	2	USB2_N
3	USB2_P	4	GND
5	+5V	6	USB2_N
7	USB2_P	8	GND

### LAN2

Pin	Definition	Pin	Definition
9	+1V5_LAN	10	LAN_MDI0P
11	LAN_MDI0N	12	LAN_MDI1P
13	LAN_MDI1N	14	LAN_MDI2P
15	LAN_MDI2N	16	LAN_MDI3P
17	LAN_MDI3N	18	GND
19	LAN_LINK_1G#	20	LAN_LINK_100#
21	LAN_LED_ACT#	22	+3VSB

## DVI-D Connector

Connector type: 24-pin D-Sub, 2.0mm-M-180 (DVI)

Connector location: CON2

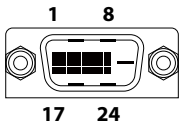

Pin	Definition	Pin	Definition
1	DVI_DATA2_N	2	DVI_DATA2_P
3	GND	4	NC
5	NC	6	DVI_CLK
7	DVI_DAT	8	NC
9	DVI_DATA1_N	10	DVI_DATA1_P
11	GND	12	NC
13	NC	14	+5V
15	GND	16	DVI_HPD
17	DVI_DATA0_N	18	DVI_DATA0_P
19	GND	20	NC
21	NC	22	NC
23	DVI_CLK_P	24	DVI_CLK_N

## COM 1 Port

Connector type: DB-9 port, 9-pin D-Sub

Connector location: CN7

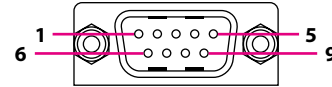

Pin	Definition	Pin	Definition
1	DCD#	2	RXD
3	TXD	4	DTR#
5	GND	6	DSR#
7	RTS#	8	CTS#
9	RI#		
MH1	GND	MH2	GND

## 24V DC Power Input

Connector type: Phoenix Contact 1x3 3-pin terminal block

Connector location: PW1

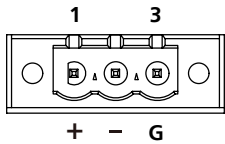

Pin	Definition
1	VIN
2	VSS
3	CHASSIS_GND

## Internal Connectors

### Debug Port

Connector type: 1x10 10-pin header, 1.0mm pitch

Connector location: J4



Pin	Definition	Pin	Definition
1	GND	2	PLTRST#
3	LPC_CLK	4	LPC_FRAME#
5	LPC_AD3	6	LPC_AD2
7	LPC_AD1	8	LPC_ADO
9	+3V3	10	+3V3
MH1	GND	MH2	GND

### Battery Connector

Connector type: 1x2 2-pin header, 1.25mm pitch

Connector location: J3

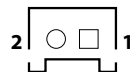

Pin	Definition
1	VCC3
2	GND

### Audio HDA Pin Header

Connector type: 2x5 10-pin header, 2.54mm pitch

Connector location: JHDA1

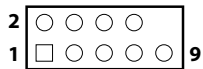

Pin	Definition	Pin	Definition
1	HDA_SDO	2	+5V
3	HDA_RST#	4	GND
5	HDA_SYNC	6	+12V
7	HDA_SDI0	8	HDA_SDI1
9	HDA_CLK	10	NC

### COM2 Connector

Connector type: 1x10 10-pin header, 1.0mm pitch

Connector location: J5

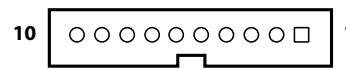

Pin	Definition	Pin	Definition
1	DCD#	2	RXD
3	TXD	4	DTR#
5	GND	6	DSR#
7	RTS#	8	CTS#
9	RI#	10	GND
MH1	GND	MH2	GND

## SATA Connector 1

Connector type: Standard Serial ATA 7P (1.27mm, SATA-M-180)

Connector location: CN4

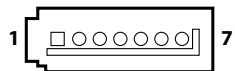

Pin	Definition	Pin	Definition
1	GND	2	SATA_TXP1
3	SATA_TXN1	4	GND
5	SATA_RXN1	6	SATA_RXP1
7	GND		
MH1	GND	MH2	GND

## SATA Connector 2

Connector type: Standard Serial ATA 7P (1.27mm, SATA-M-180)

Connector location: CN3

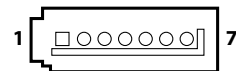

Pin	Definition	Pin	Definition
1	GND	2	SATA_TXP2
3	SATA_TXN2	4	GND
5	SATA_RXN2	6	SATA_RXP2
7	GND		
MH1	GND	MH2	GND

## SATA Power Connector 1

Connector type: 1x2 2-pin header, 2.5mm pitch

Connector location: J1

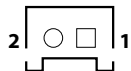

Pin	Definition
1	VCC5
2	GND

## SATA Power Connector 2

Connector type: 1x2 2-pin header, 2.5mm pitch

Connector location: J2

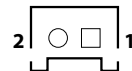

Pin	Definition
1	VCC5
2	GND



## FAN Connector

Connector type: 1x4 4-pin Wafer, 2.54mm pitch

Connector location: CN2

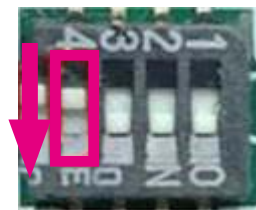
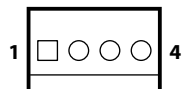

Pin	Definition
1	GND
2	+12V
3	FAN_TAC
4	FAN_CONTROL



Note: Turn the 4th DIP switch of SW2 from off to on, this way the Remote On/Off Switch Connector can be used for support. However, it must be connected to a single cut switch and not connected to tact switch.

## Mini-PCIe Connector

Connector location: CN5

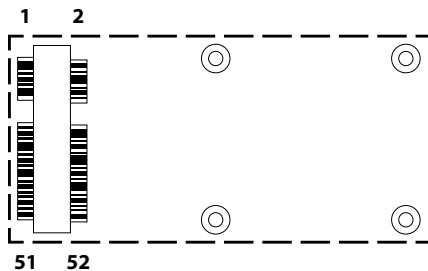

Pin	Definition	Pin	Definition
1	PCIE_WAKE#	2	3VSB
3	NC	4	GND
5	NC	6	1.5V
7	CLKREQ#	8	NC
9	GND	10	NC
11	PCIE_CLK#	12	NC
13	PCIE_CLK	14	NC
15	GND	16	NC
17	NC	18	GND
19	NC	20	DISABLE#
21	GND	22	PCIE_RESET#
23	PCIE_RXN	24	3VSB
25	PCIE_RXP	26	GND

Pin	Definition	Pin	Definition
27	GND	28	1.5V
29	GND	30	SMB_CLK
31	PCIE_TXN	32	SMB_DATA
33	PCIE_TXP	34	GND
35	GND	36	USB_N
37	GND	38	USB_P
39	3VSB	40	GND
41	3VSB	42	NC
43	GND	44	NC
45	NC	46	NC
47	NC	48	1.5V
49	NC	50	GND
51	NC	52	3VSB

## PCIe x8 Slot

Connector type: PCIe x8 Slot

Connector location: CN1

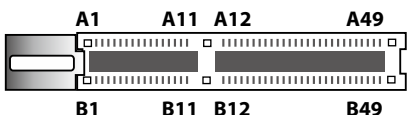

Pin	Definition	Pin	Definition
A1	PCIE_PRSNT1	B1	+12V
A2	+12V	B2	+12V
A3	+12V	B3	+12V
A4	GND	B4	GND
A5	PEG_CLK_P10	B5	PCIE_SMB_CLK
A6	PEG_CLK_N10	B6	PCIE_SMB_DAT
A7	NC	B7	GND
A8	NC	B8	+3V3
A9	+3V3	B9	NC
A10	+3V3	B10	+3VSB
A11	PLT_RST#	B11	PCIE_WAKE#
A12	GND	B12	NC
A13	PEG_CLK_P11	B13	GND
A14	PEG_CLK_N11	B14	PEG_TXP8
A15	GND	B15	PEG_TXN8
A16	PEG_RXP8	B16	GND
A17	PEG_RXN8	B17	PCIE_PRSNT2_1
A18	GND	B18	GND
A19	NC	B19	PEG_TXP9
A20	GND	B20	PEG_TXN9
A21	PEG_RXP9	B21	GND

Pin	Definition	Pin	Definition
A22	PEG_RXN9	B22	GND
A23	GND	B23	PEG_TXP10
A24	GND	B24	PEG_TXN10
A25	PEG_RXP10	B25	GND
A26	PEG_RXN10	B26	GND
A27	GND	B27	PEG_TXP11
A28	GND	B28	PEG_TXN11
A29	PEG_RXP11	B29	GND
A30	PEG_RXN11	B30	NC
A31	GND	B31	PCIE_PRSNT2_2
A32	NC	B32	GND
A33	NC	B33	PEG_TXP12
A34	GND	B34	PEG_TXN12
A35	PEG_RXP12	B35	GND
A36	PEG_RXN12	B36	GND
A37	GND	B37	PEG_TXP13
A38	GND	B38	PEG_TXN13
A39	PEG_RXP13	B39	GND
A40	PEG_RXN13	B40	GND
A41	GND	B41	PEG_TXP14
A42	GND	B42	PEG_TXN14
A43	PEG_RXP14	B43	GND
A44	PEG_RXN14	B44	GND
A45	GND	B45	PEG_TXP15
A46	GND	B46	PEG_TXN15
A47	PEG_RXP15	B47	GND
A48	PEG_RXN15	B48	PCIE_PRSNT2_3
A49	GND	B49	GND

# CHAPTER 3: BIOS SETUP

This chapter describes how to use the BIOS setup program for the CMC300-Fxx series. The BIOS screens provided in this chapter are for reference only and may change if the BIOS is updated in the future.

To check for the latest updates and revisions, visit the NexAloT website at [www.nexaiot.com](http://www.nexaiot.com).

## About BIOS Setup

The BIOS (Basic Input and Output System) Setup program is a menu driven utility that enables you to make changes to the system configuration and tailor your system to suit your individual work needs. It is a ROM-based configuration utility that displays the system's configuration status and provides you with a tool to set system parameters.

These parameters are stored in non-volatile battery-backed-up CMOS RAM that saves this information even when the power is turned off. When the system is turned back on, the system is configured with the values found in CMOS.

With easy-to-use pull down menus, you can configure items such as:

- Hard drives, diskette drives, and peripherals
- Video display type and display options
- Password protection from unauthorized use
- Power management features

The settings made in the setup program affect how the computer performs. It is important, therefore, first to try to understand all the setup options, and second, to make settings appropriate for the way you use the computer.

## When to Configure the BIOS

- This program should be executed under the following conditions:
  - When changing the system configuration
  - When a configuration error is detected by the system and you are prompted to make changes to the setup program
  - When resetting the system clock
  - When redefining the communication ports to prevent any conflicts
  - When making changes to the Power Management configuration
  - When changing the password or making other changes to the security setup

Normally, CMOS setup is needed when the system hardware is not consistent with the information contained in the CMOS RAM, whenever the CMOS RAM has lost power, or the system features need to be changed.

## Default Configuration

Most of the configuration settings are either predefined according to the Load Optimal Defaults settings which are stored in the BIOS or are automatically detected and configured without requiring any actions. There are a few settings that you may need to change depending on your system configuration.

## Entering Setup











When the system is powered on, the BIOS will enter the Power-On Self Test (POST) routines. These routines perform various diagnostic checks; if an error is encountered, the error will be reported in one of two different ways:

- If the error occurs before the display device is initialized, a series of beeps will be transmitted.
- If the error occurs after the display device is initialized, the screen will display the error message.

Powering on the computer and immediately pressing <Del> allows you to enter Setup.

Press the  key to enter Setup:

## Legends

Key	Function
	Moves the highlight left or right to select a menu.
	Moves the highlight up or down between sub-menus or fields.
	Exits the BIOS Setup Utility.
	Scrolls forward through the values or options of the highlighted field.
	Scrolls backward through the values or options of the highlighted field.
	Selects a field.
	Displays General Help.
	Load previous values.
	Load optimized default values.
	Saves and exits the Setup program.
	Press <Enter> to enter the highlighted sub-menu.

### Scroll Bar

When a scroll bar appears to the right of the setup screen, it indicates that there are more available fields not shown on the screen. Use the up and down arrow keys to scroll through all the available fields.

### Submenu

When “▶” appears on the left of a particular field, it indicates that a submenu which contains additional options are available for that field. To display the submenu, move the highlight to that field and press  .

## BIOS Setup Utility

Once you enter the AMI BIOS Setup Utility, the Main Menu will appear on the screen. The main menu allows you to select from several setup functions and one exit. Use arrow keys to select among the items and press  to accept or enter the submenu.

### Main

The Main menu is the first screen that you will see when you enter the BIOS Setup Utility.

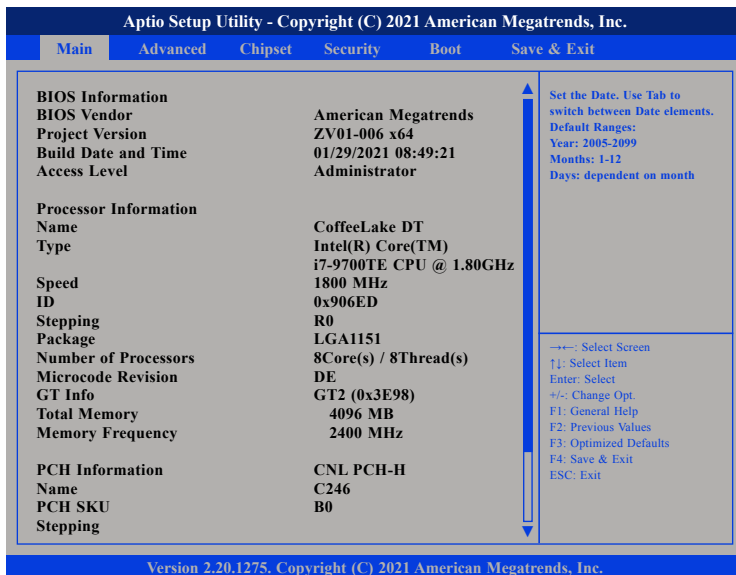

Aptio Setup Utility - Copyright (C) 2021 American Megatrends, Inc.					
Main	Advanced	Chipset	Security	Boot	Save & Exit
<b>BIOS Information</b>					
BIOS Vendor	American Megatrends				
Project Version	ZV01-006 x64				
Build Date and Time	01/29/2021 08:49:21				
Access Level	Administrator				
<b>Processor Information</b>					
Name	CoffeeLake DT				
Type	Intel(R) Core(TM) i7-9700TE CPU @ 1.80GHz				
Speed	1800 MHz				
ID	0x906ED				
Stepping	R0				
Package	LGA1151				
Number of Processors	8Core(s) / 8Thread(s)				
Microcode Revision	DE				
GT Info	GT2 (0x3E98)				
Total Memory	4096 MB				
Memory Frequency	2400 MHz				
<b>PCH Information</b>					
Name	CNL PCH-H				
PCH SKU	C246				
Stepping	B0				

Set the Date. Use Tab to switch between Date elements.  
 Default Ranges:  
 Year: 2005-2099  
 Months: 1-12  
 Days: dependent on month

←→: Select Screen  
 ↑↓: Select Item  
 Enter: Select  
 +/-: Change Opt.  
 F1: General Help  
 F2: Previous Values  
 F3: Optimized Defaults  
 F4: Save & Exit  
 ESC: Exit

Version 2.20.1275. Copyright (C) 2021 American Megatrends, Inc.

### System Date

The date format is <day>, <month>, <date>, <year>. Day displays a day, from Monday to Sunday. Month displays the month, from January to December. Date displays the date, from 1 to 31. Year displays the year, from 2005 to 2099.

### System Time

The time format is <hour>, <minute>, <second>. The time is based on the 24-hour military-time clock. For example, 1 p.m. is 13:00:00. Hour displays hours from 00 to 23. Minute displays minutes from 00 to 59. Second displays seconds from 00 to 59.

## Advanced

The Advanced menu allows you to configure your system for basic operation. Some entries are defaults required by the system board, while others, if enabled, will improve the performance of your system or let you set some features according to your preference.



Setting incorrect field values may cause the system to malfunction.

**Aptio Setup Utility - Copyright (C) 2021 American Megatrends, Inc.**

Main | **Advanced** | Chipset | Security | Boot | Save & Exit

- ▶ CPU Configuration
- ▶ Power & Performance
- ▶ AMT Configuration
- ▶ ACPI Settings
- ▶ IT8786 Super IO Configuration
- ▶ Hardware Monitor
- ▶ USB Configuration
- ▶ Network Stack Configuration

**CPU Configuration Parameters**

←→: Select Screen  
 ↑↓: Select Item  
 Enter: Select  
 +/-: Change Opt.  
 F1: General Help  
 F2: Previous Values  
 F3: Optimized Defaults  
 F4: Save & Exit  
 ESC: Exit

Version 2.20.1275. Copyright (C) 2021 American Megatrends, Inc.

## CPU Configuration

This section displays the information of the CPU installed.

**Aptio Setup Utility - Copyright (C) 2021 American Megatrends, Inc.**

Main | **Advanced** | Chipset | Security | Boot | Save & Exit

**CPU Configuration**

Type	Intel(R) Core(TM) i7-9700TE CPU @ 1.80GHz
ID	0x906ED
Speed	1800 MHz
L1 Data Cache	32 KB x 8
L1 Instruction Cache	32 KB x 8
L2 Cache	256 KB x 8
L3 Cache	12 MB
L4 Cache	N/A
VMX	Supported
SMX/TXT	Supported

←→: Select Screen  
 ↑↓: Select Item  
 Enter: Select  
 +/-: Change Opt.  
 F1: General Help  
 F2: Previous Values  
 F3: Optimized Defaults  
 F4: Save & Exit  
 ESC: Exit

Version 2.20.1275. Copyright (C) 2021 American Megatrends, Inc.



## ACPI Settings

This section is used to configure ACPI settings.



### Enable Hibernation

Enables or disables system ability to hibernate (OS/S4 Sleep State). This option may not be effective with some OS.

### ACPI Sleep State

Select the highest ACPI sleep state the system will enter when the suspend button is pressed. The options are Suspend Disabled and S3 (Suspend to RAM).

## IT8786 Super IO Configuration

This section is used to configure the serial ports.

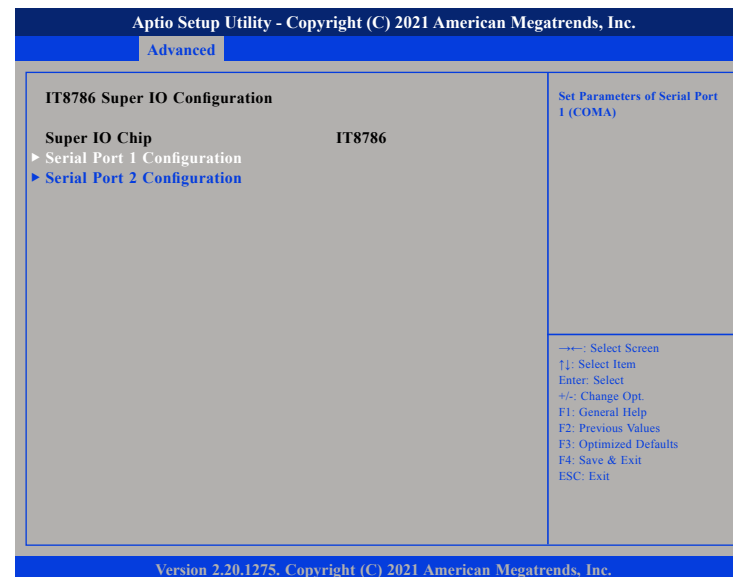

### Super IO Chip

Displays the Super I/O chip used on the board.

## Serial Port 1 Configuration

This section is used to configure serial port 1.



### Serial Port

Enables or disables the serial port.

### Onboard Serial Port Mode

Select this to change the serial port mode to RS232, RS422, RS485 or RS485 Auto.

### Terminal 120 Ohm

Enables or disables serial port terminal resistance.

## Hardware Monitor

This section is used to monitor hardware status such as temperature, fan speed and voltages.

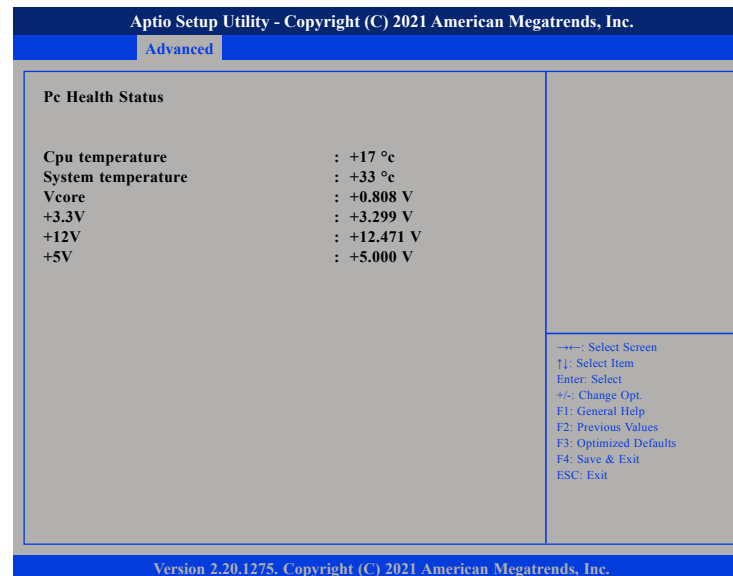

### CPU temperature

Detects and displays the current CPU temperature.

### System temperature

Detects and displays the current system temperature.

### Vcore to +5V

Detects and displays the output voltages.

## USB Configuration

This section is used to configure the USB.



### XHCI Hand-off

This is a workaround for OSs that does not support XHCI hand-off. The XHCI ownership change should be claimed by the XHCI driver respectively.

### USB Mass Storage Driver Support

Enables or disables USB mass storage driver support.

### USB transfer time-out

The time-out value for control, bulk, and Interrupt transfers.

### Device reset time-out

Selects the USB mass storage device's start unit command timeout.

### Device power-up delay

Maximum time the value will take before it properly reports itself to the Host Controller. "Auto" uses default value: for a Root port it is 100 ms, for a Hub port the delay is taken from Hub descriptor.

## Chipset

This section gives you functions to configure the system based on the specific features of the chipset. The chipset manages bus speeds and access to system memory resources.



### SATA Controller(s)

Enables or disables the SATA controller.

### SATA Mode Selection

Configures the SATA mode. The options are AHCI and Intel RST Premium.

### SATA Test Mode

Enables or disables SATA test mode.

### Aggressive LPM Support

Enables or disables PCH to aggressively enter link power state.

## Security

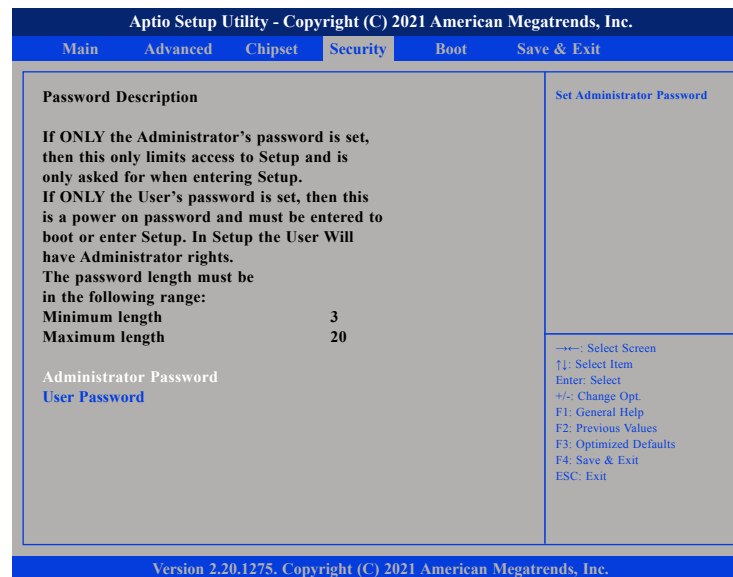

### Administrator Password

Select this to reconfigure the administrator's password.

### User Password

Select this to reconfigure the user's password.

## Boot



### Setup Prompt Timeout

Configures the number of seconds to wait for setup activation key. 65535 (0xFFFF) means indefinite waiting.

### Bootup NumLock State

This allows you to determine the default state of the numeric keypad. By default, the system boots up with NumLock on wherein the function of the numeric keypad is the number keys. When set to Off, the function of the numeric keypad is the arrow keys.

### Boot Option Priorities

Adjust the boot sequence of the system. Boot Option #1 is the first boot device that the system will boot from, next will be #2 and so forth.

## Save & Exit



### Save Changes and Reset

To save the changes and reset, select this field then press <Enter>. A dialog box will appear. Confirm by selecting Yes.

### Discard Changes and Reset

To exit the setup utility and reset without saving the changes, select this field then press <Enter>. You may be prompted to confirm again before exiting.

### Restore Defaults

To restore the BIOS to default settings, select this field then press <Enter>. A dialog box will appear. Confirm by selecting Yes.

# APPENDIX A: POWER CONSUMPTION

CRB	Net Name										
Chipset	Voltage	12V	5V	5V	3.3V	3.3V	1.05V	1.2V	1.5V	1.8V	Subtotal Power
	Net Name	+12V	+5VSB	+5V	+3VSB	+3V3	+1V05SB	+1V2	+1V5	+1V8	
Coffee lake-S (35W)							0.23				
PCH H Q370					2.1		8.1				
DDR4 SO-DIMM x 2											
CH7517A						0.1		0.2			
PTN3360						0.1					
I219LM					0.5						
I211-AT					0.5						
SIO IT8786				0.5	0.1	0.2				0.1	
ALC886				0.1		0.1					
Mini-PCIe					2.75				0.5		
USB3 x 2			1.8								
USB2 x 2			1								
SATA x 2				3							
COM (RS232/RS422/RS485)				0.35							
PCIe x8 Slot		3.1			0.6	5					
Fan		1									
<b>System Total Current (A)</b>		<b>4.1</b>	<b>2.8</b>	<b>3.95</b>	<b>6.55</b>	<b>5.5</b>	<b>8.33</b>	<b>0.2</b>	<b>0.5</b>	<b>0.1</b>	
<b>System Total Watt (W)</b>		<b>49.2</b>	<b>14</b>	<b>19.8</b>	<b>21.615</b>	<b>18.15</b>	<b>8.7465</b>	<b>0.24</b>	<b>0.75</b>	<b>0.18</b>	

CRB	Net Name									
Chipset	Voltage	1.8V	2.5V	0.6V	1.2V	0.95V	1.05V	1.52V	1.52V	Subtotal Power
	Net Name	+1V8SB	VPP	VDDQ_VTT	VDDQ	VCCIO	VCCSA	VCCGT	VCORE	
Coffee lake-S (35W)					3.43	6.4	11.1	35	66	
PCH H Q370	0.5									
DDR4 SO-DIMM x 2			2	1	6					
CH7517A										
PTN3360										
I219LM										
I211-AT										
SIO IT8786										
ALC886										
Mini-PCIe										
USB3 x 2										
USB2 x 2										
SATA x 2										
COM (RS232/RS422/RS485)										
PCIe x8 Slot										
Fan										
<b>System Total Current (A)</b>		<b>0.5</b>	<b>2</b>	<b>1</b>	<b>9.43</b>	<b>6.4</b>	<b>11.1</b>	<b>35</b>	<b>66</b>	
<b>System Total Watt (W)</b>		<b>0.9</b>	<b>2</b>	<b>0.6</b>	<b>11.316</b>	<b>6.08</b>	<b>16.872</b>	<b>53.2</b>	<b>100.32</b>	