

# QBiX-WP-WHLA8265H-A1 (QW-8265A-SI)

QBiX-WP Waterproof Industrial Embedded System  
Quick Start Guide

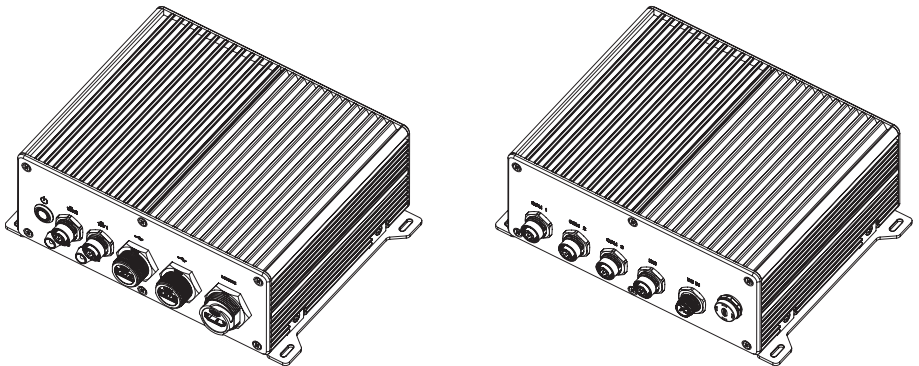

## Copyright Notice

---

This document is copyrighted, 2019. All rights are reserved. The original manufacturer reserves the right to make improvements to the products described in this manual at any time without notice.

No part of this manual may be reproduced, copied, translated, or transmitted in any form or by any means without the prior written permission of the original manufacturer. Information provided in this manual is intended to be accurate and reliable. However, the original manufacturer assumes no responsibility for its use, or for any infringements upon the rights of third parties that may result from its use.

The material in this document is for product information only and is subject to change without notice. While reasonable efforts have been made in the preparation of this document to assure its accuracy, GIGAIPC assumes no liabilities resulting from errors or omissions in this document, or from the use of the information contained herein. GIGAIPC reserves the right to make changes in the product design without notice to its users.

## Acknowledgement

---

All other products' name or trademarks are properties of their respective owners.

- AMD is trademark of Advanced Micro Devices.
- Microsoft Windows is a registered trademark of Microsoft Corp.
- Intel, Pentium, Celeron, and Xeon are registered trademarks of Intel Corporation
- Core, Atom are trademarks of Intel Corporation
- ITE is a trademark of Integrated Technology Express, Inc.
- IBM, PC/AT, PS/2, and VGA are trademarks of International Business Machines Corporation.

All other product names or trademarks are properties of their respective owners.

## Packing List

---

Before setting up your product, please make sure the following items have been shipped:

Item	Quantity
COM Cable, waterproof (25CF8-1K8400-OOS)	3
USB 2.0 Cable, waterproof (25CFA-1K8000-OOR)	2
RJ45 Cable, waterproof (25CR0-1K8401-OOS)	2
SIGNAL Cable, waterproof (25CR5-1K8500-OOR)	1
HDMI Cable, waterproof (25CRC-180720-OOS)	1
DC JACK Cable, waterproof (25CRD-1K8300-OOS)	1
Wall mount (25HBA-826520-H5R)	2
Exsiccator (10g)	1

If any of these items are missing or damaged, please contact your distributor or sales representative immediately.

## About this Document

---

This User's Manual contains all the essential information, such as detailed descriptions and explanations on the product's hardware and software features (if any), its specifications, dimensions, jumper/connector settings/definitions, and driver installation instructions (if any), to facilitate users in setting up their product.

Users may refer to the [GIGAIPC.com](http://GIGAIPC.com) for the latest version of this document.

## Safety Precautions

---

Please read the following safety instructions carefully. It is advised that you keep this manual for future references

1. All cautions and warnings on the device should be noted.
2. Make sure the power source matches the power rating of the device.
3. Position the power cord so that people cannot step on it. Do not place anything over the power cord.
4. Always completely disconnect the power before working on the system's hardware.
5. No connections should be made when the system is powered as a sudden rush of power may damage sensitive electronic components.
6. If the device is not to be used for a long time, disconnect it from the power supply to avoid damage by transient over-voltage.
7. Always disconnect this device from any AC supply before cleaning.
8. While cleaning, use a damp cloth instead of liquid or spray detergents.
9. Make sure the device is installed near a power outlet and is easily accessible.
10. Keep this device away from humidity.
11. Place the device on a solid surface during installation to prevent falls
12. Do not cover the openings on the device to ensure optimal heat dissipation.

13. Watch out for high temperatures when the system is running.
14. Do not touch the heat sink or heat spreader when the system is running
15. Never pour any liquid into the openings. This could cause fire or electric shock.
16. As most electronic components are sensitive to static electrical charge, be sure to ground yourself to prevent static charge when installing the internal components. Use a grounding wrist strap and contain all electronic components in any static-shielded containers.
17. If any of the following situations arises, please the contact our service personnel:
  - i. Damaged power cord or plug
  - ii. Liquid intrusion to the device
  - iii. Exposure to moisture
  - iv. Device is not working as expected or in a manner as described in this manual
  - v. The device is dropped or damaged
  - vi. Any obvious signs of damage displayed on the device

**18. DO NOT LEAVE THIS DEVICE IN AN UNCONTROLLED ENVIRONMENT WITH TEMPERATURES BEYOND THE DEVICE'S PERMITTED STORAGE TEMPERATURES (SEE CHAPTER 1) TO PREVENT DAMAGE.**

## FCC Statement

---

### **Warning!**



This device complies with Part 15 FCC Rules. Operation is subject to the following two conditions: (1) this device may not cause harmful interference, and (2) this device must accept any interference received including interference that may cause undesired operation.

### **Caution:**

*There is a danger of explosion if the battery is incorrectly replaced. Replace only with the same or equivalent type recommended by the manufacturer. Dispose of used batteries according to the manufacturer's instructions and your local government's recycling or disposal directives.*

### **Attention:**

*Il y a un risque d'explosion si la batterie est remplacée de façon incorrecte. Ne la remplacer qu'avec le même modèle ou équivalent recommandé par le constructeur. Recycler les batteries usées en accord avec les instructions du fabricant et les directives gouvernementales de recyclage.*

## High Temperature Warning

---

(1) This equipment is intended to be used in Restrict Access Location. The access can only be gained by Skilled person or by Instructed person who have been instructed about the metal chassis of the equipment is so hot that Skilled person have to pay special attention or take special protection.

Only authorized by well trained professional person can access the restrict access location.

(2) External metal parts are hot!! Before touching it, special attention or protection is necessary





## Table Contents

<b>QBiX-WP Waterproof Industrial Embedded System</b>	<b>1</b>
<b>Quick Start Guide</b>	
Copyright Notice .....	2
Acknowledgement .....	3
Packing List.....	4
About this Document.....	5
Safety Precautions .....	6
FCC Statement.....	8
High Temperature Warning .....	8
<b>Chapter 1 - Product Specifications</b>	<b>11</b>
1.1 Specifications .....	13
<b>Chapter 2 – QBiX-WP-WHLA8265H-A1 Waterproof Industrial Embedded System Kit</b>	<b>15</b>
2.1 Dimension .....	16
2.2 Getting Familiar with Your Unit.....	17
2.3 COM 1 Connector for RS-232/422/485 & RI/5V/12V ...	19
2.4 COM 2/3 Connector for RS-232.....	19
2.5 DIO Connector .....	19
2.6 DC-IN Connector .....	20
2.7 LAN 1/2 Connectors .....	20
2.8 USB 1/2 Connectors for USB 2.0.....	20
2.9 HDMI 1.4 Connector .....	21

2.10	Support .....	22
2.11	Safety and Regulatory Information.....	23

## Chapter 3 – Hardware Information 25

3.1	Jumpers and Connectors .....	26
3.2.1	CPU FAN (CPU FAN connector) .....	29
3.2.2	System FAN (System FAN connector) .....	30
3.2.3	JCOM1 (COM1 RI# pin RI#/5V/12V Select).....	31
3.2.4	COM2, COM3, COM4 (Serial port header, RS-232).....	32
3.2.5	FUSB (USB 2.0 header) .....	33
3.2.6	SATAIII_0, SATAIII_1 (SATA 6Gb/s Connector) .....	34
3.2.7	GPIO_CNT (General Purpose input/output header) .....	35
3.2.8	SATAPW1, SATAPW2 (SATA power connector) .....	36
3.2.9	AT_CN (AT/ATX mode select jumper).....	37
3.2.10	DC_IN (DC IN 1x4-pin power connector ).....	38
3.2.11	SPK_OUT (Speaker out connector) .....	39
3.2.12	FP_Audio (Front Audio connector) .....	40
3.2.13	BKL_CN (Backlight Control connector) .....	41
3.2.14	SYS_PANEL (Front panel header) .....	42
3.2.15	LVDS (LVDS connector).....	43
3.2.16	LSW (LVDS resolution jumper) .....	44
3.2.17	BATTERY (Battery cable connector).....	45
3.2.18	LPC_CN (LPC Connector) .....	46
3.2.19	SODIMM1, SODIMM2 (DDR4 SO-DIMM Slot).....	47
3.2.20	M2E (M.2 Slot, E-Key, NGFF2230, WiFi & Bluetooth module).....	48

3.2.21	MPCIE (Mini PCIe full size, support 3G/4G module) .....	49
3.2.22	M2M (M.2 Slot, SATA/PCIe x4, NGFF2280) .....	50
3.2.23	SIM_CARD (SIM Card slot) .....	51
3.2.24	RUSB31_1, RUSB31_2 (USB 3.2 Gen 2x1 connector)....	52
3.2.25	HDMI21 (HDMI connector).....	53
3.2.26	LAN1, LAN2 (LAN connector).....	54
3.2.27	COM1 (Serial port connector, RS-232/422/485 & RI/5V/12V).....	55

# Chapter 1

## Chapter 1 - Product Specifications

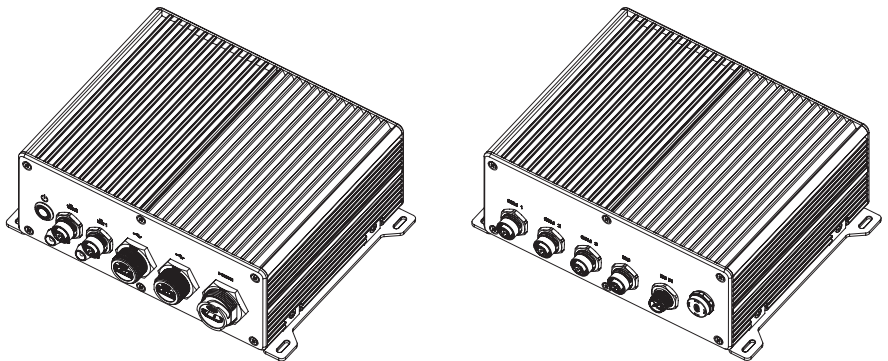

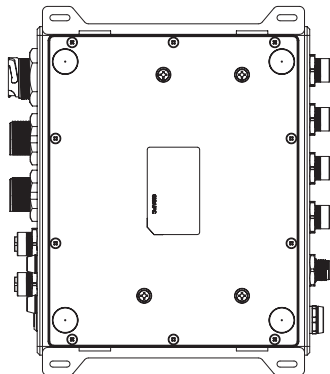
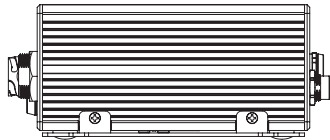
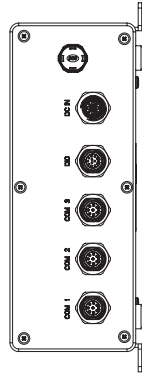
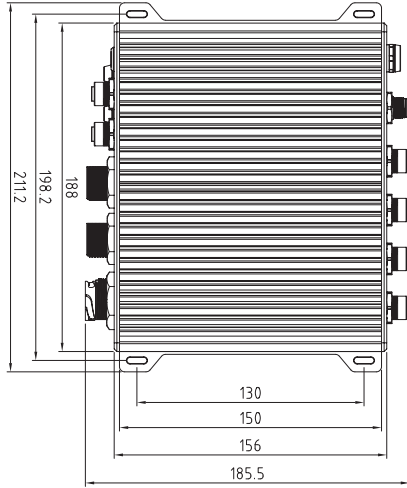
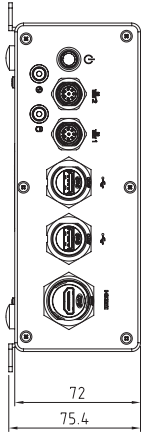

## 1.1 Specifications

System	QBiX-WP-WHLA8265H-A1 (QW-8265A-SI)
Dimension	System Size : 188W x 155D x 72H (mm)
CPU	Intel® Core™ i5-8265U Processor 14nm, 4 cores, 8 threads, up to 3.9 GHz TDP 15W
Chipset	SoC
Memory	2 x DDR4 SO-DIMM sockets, Max. Capacity 64 GB Support Dual Channel DDR4 2400 MHz memory modules (Integrated 8GB memory)
Ethernet	2 x GbE LAN Ports (Intel® I219V and Intel® I211AT)
Graphic support	Integrated Graphics Processor - Intel® UHD Graphics 620: 1 x HDMI 1.4 port, supporting a maximum resolution of 4096x2160 @30Hz
Audio	Realtek® Audio Codec
Storage	1 x 2.5" HDD/SSD (SATA 6Gb/s)
Expansion Slots	1 x 2280 M.2 M-Key (PCIe x4, SATA 6Gb/s) 1 x 2230 M.2 E-Key (WiFi/BT) 1 x Full-size Mini PCIe with SIM slot (PCIe x1 + USB2.0) -- support 3G/4G module (Integrated M.2 SSD 256GB)
Front I/O	2 x (M12) LAN Ports 2 x (IP67) USB 2.0 connector 1 x (IP67) HDMI connector 1 x (IP67) Power switch 1 x (M8) Power & HDD LED
Rear I/O	1 x (M12) COM Port (RS-232/422/485 & RI/5V/12V) 2 x (M12) COM Port (RS-232) 1 x (M12) GPIO (8 bits) 1 x (M12) DC Jack
TPM	—
Power	+9V~36VDC (Full Range)
Operation temperature	Operating temperature: -20°C to 70°C Operating humidity: 0-90% (non-condensing) Non-operating temperature: -20°C to 70°C Non-operating humidity: 0%-95% (non-condensing) Use wide temperature range memory and storage

System	QBiX-WP-WHLA8265H-A1 (QW-8265A-SI)
Vibration During Operation	Operation: IEC 60068-2-64, 3 Grms, random, 5 ~ 500 Hz, 1 hr / Per Axis, With SSD/M.2 2280 Non-operation: IEC 60068-2-6, 2 G, Sine, 10 ~ 500 Hz, 1 Oct/ min, 1 hr / Per Axis
Shock During Operation	Operation: IEC 60068-2-27, 50 G, half sine, 11 ms duration, with SSD
Packaging Content	Carton size: 305 x 285 x 265 (mm) Packing Capacity: 1pc  Including: COM Cable, waterproof, x 3 (P/N: 25CF8-1K8400-O0S) USB 2.0 Cable, waterproof, x 2 (P/N: 25CFA-1K8000-O0R) RJ45 Cable, waterproof, x 2 (P/N: 25CRO-1K8401-O0S) SIGNAL Cable, waterproof, x 1 (P/N: 25CR5-1K8500-O0R) HDMI Cable, waterproof, x 1 (P/N: 25CRC-180720-O0S) DC JACK Cable, waterproof, x 1 (P/N: 25CRD-1K8300-O0S) Wall mount bracket (P/N: 25HBA-826520-H5R)
Order Information	System: 9BQW8265AMR-SI (Box packing)  (Built in Components: Please contact with your sales representative for more information or e-mailed to : sales@gigaipc.com)

## Chapter 2

---

### Chapter 2 – QBiX-WP-WHLA8265H-A1 Waterproof Industrial Embedded System Kit

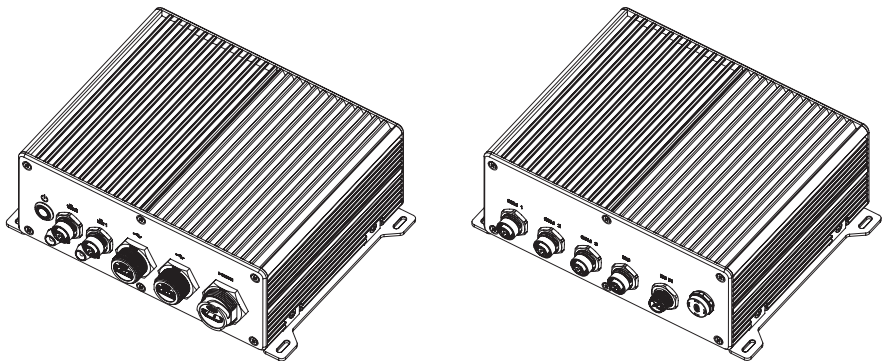



## 2.1 Dimension

---

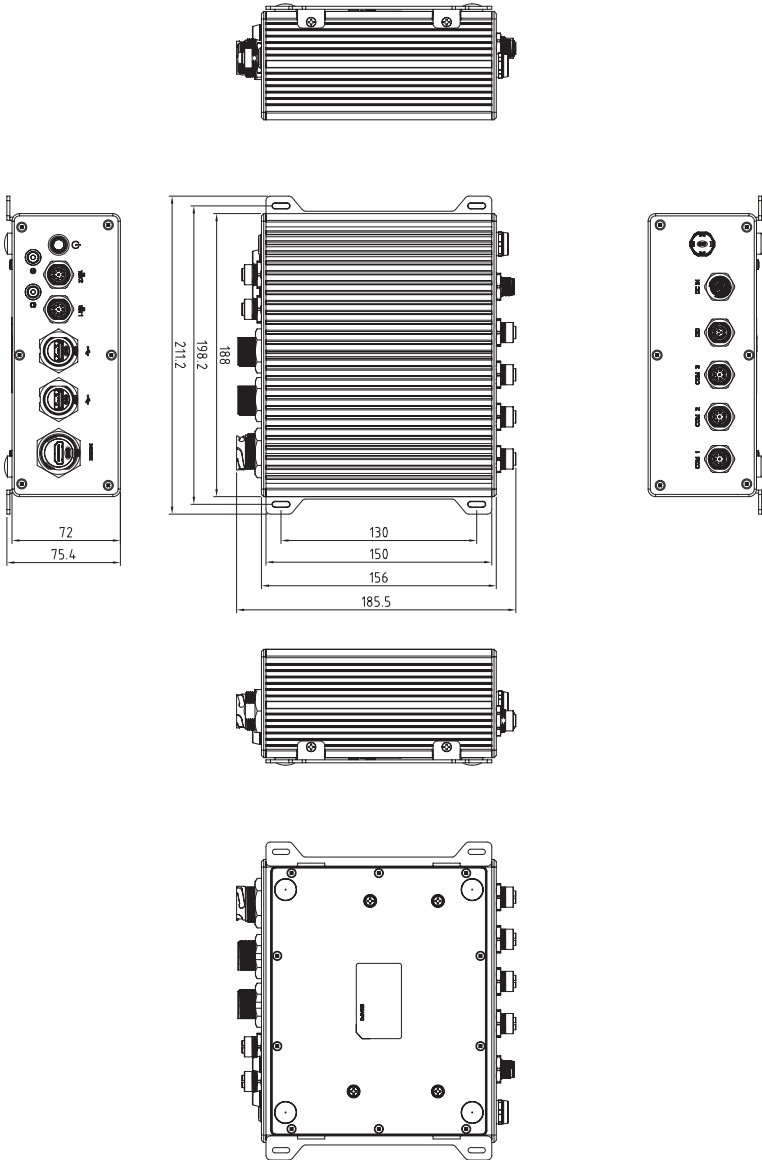

## 2.2 Getting Familiar with Your Unit

### [Front Side]

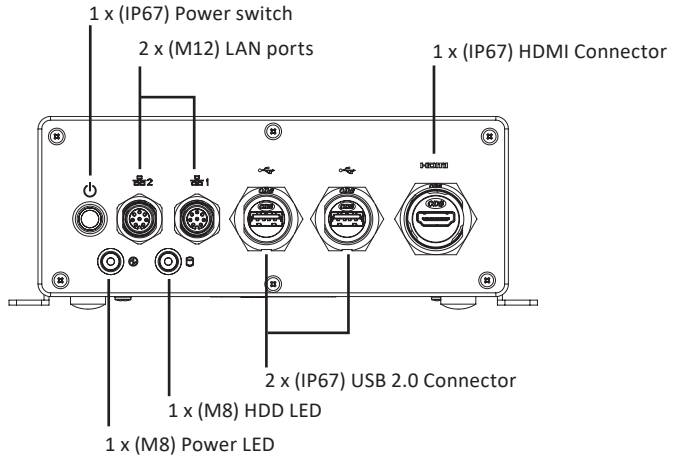

### [Rear Side]

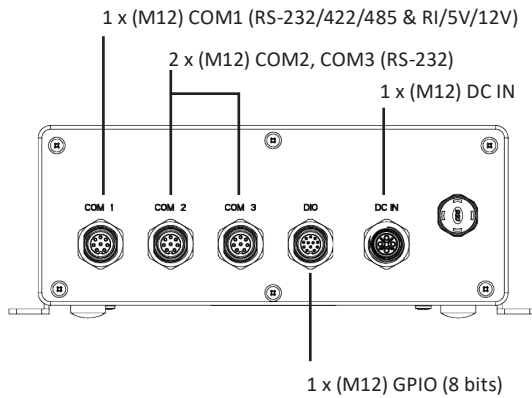

**[Left Side]**

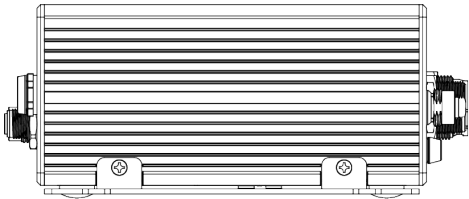

**[Right Side]**

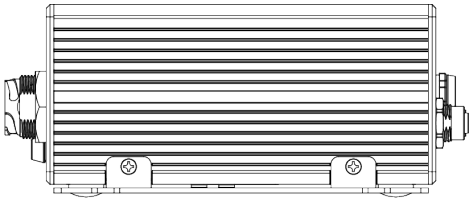

**[Bottom Side]**

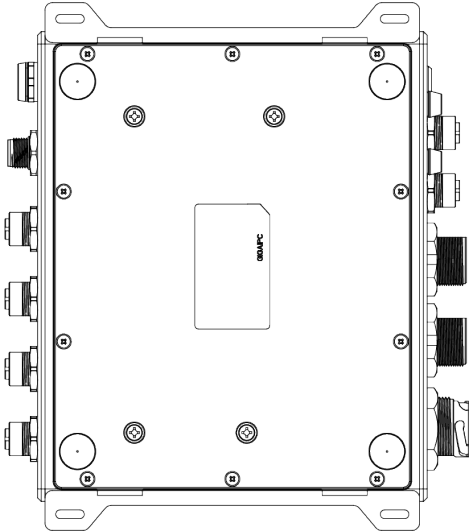

## 2.3 COM 1 Connector for RS-232/422/485 & RI/5V/12V

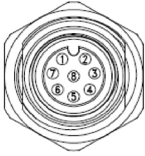

Pin Assignments  
Front View

Pin No.	Pin Define	Pin No.	Pin Define
1	DCD	6	RTS
2	RXD	7	CTS
3	TXD	8	RI
4	DTR	Shield	GND
5	DSR	—	—

## 2.4 COM 2/3 Connector for RS-232

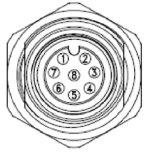

Pin Assignments  
Front View

Pin No.	Pin Define	Pin No.	Pin Define
1	DCD	6	RTS
2	RXD	7	CTS
3	TXD	8	RI
4	DTR	Shield	GND
5	DSR	—	—

## 2.5 DIO Connector



Pin Assignments  
Front View

Pin No.	Pin Define	Pin No.	Pin Define
1	GPO1	7	GPO4
2	GPI1	8	GPI4
3	GPO2	9	SMB_CLK
4	GPI2	10	SMB_DATA
5	GPO3	11	5V/ 1A
6	GPI3	—	—

## 2.6 DC-IN Connector

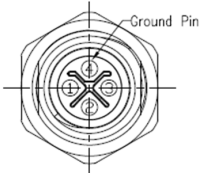

Pin Assignments  
Front View

Pin No.	Pin Define
1	V-
2	V+
3	
4	Chassis Ground

## 2.7 LAN 1/2 Connectors

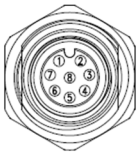

Pin Assignments  
Front View

Pin No.	Pin Define	Pin No.	Pin Define
1	TX +	5	No Signal
2	TX -	6	RX-
3	RX+	7	No Signal
4	No Signal	8	No Signal

## 2.8 USB 1/2 Connectors for USB 2.0

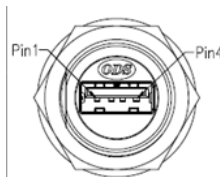

Conn.1 & Conn.2 Pin Assignments Front View

## 2.9 HDMI 1.4 Connector

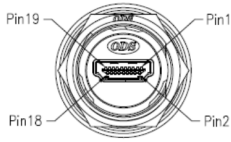

Pin Assignments  
Front View

Pin No.	Pin Define	Pin No.	Pin Define
1	D2+	10	Clock+
2	D2 / Shield	11	Clock / Shield
3	D2-	12	Clock-
4	D1+	13	CEC
5	D1 / Shield	14	Utility
6	D1-	15	SCL
7	D0+	16	SDA
8	D0 / Shield	17	GND
9	D0-	18	5V+ Power
—	—	19	Hot Plug Detect

## 2.10 Support

---

- For a list of tested memory, M.2, 2.5'' SSD, wireless adapters and OS supported, go to: <http://www.gigaipc.com>
- To download the latest drivers and BIOS updates, go to: <http://www.gigaipc.com>
- For product support, go to: <http://www.gigaipc.com>

## 2.11 Safety and Regulatory Information

---

Risk of explosion if the battery is replaced with an incorrect type. Batteries should be recycled where possible.

Disposal of used Batteries must be in accordance with local environmental regulations.

Failure to use the included Power Adapter may violate regulatory compliance and may expose the user to safety hazards.

**HDMI**™  
HIGH DEFINITION MULTIMEDIA INTERFACE



At the end of its serviceable life, this product should not be treated as household or general waste. It should be handed over to the applicable collection point for the recycling of electrical and electronic equipment, or returned to the supplier for disposal.





# Chapter 3

---

## Chapter 3 – Hardware Information

# 3.1 Jumpers and Connectors

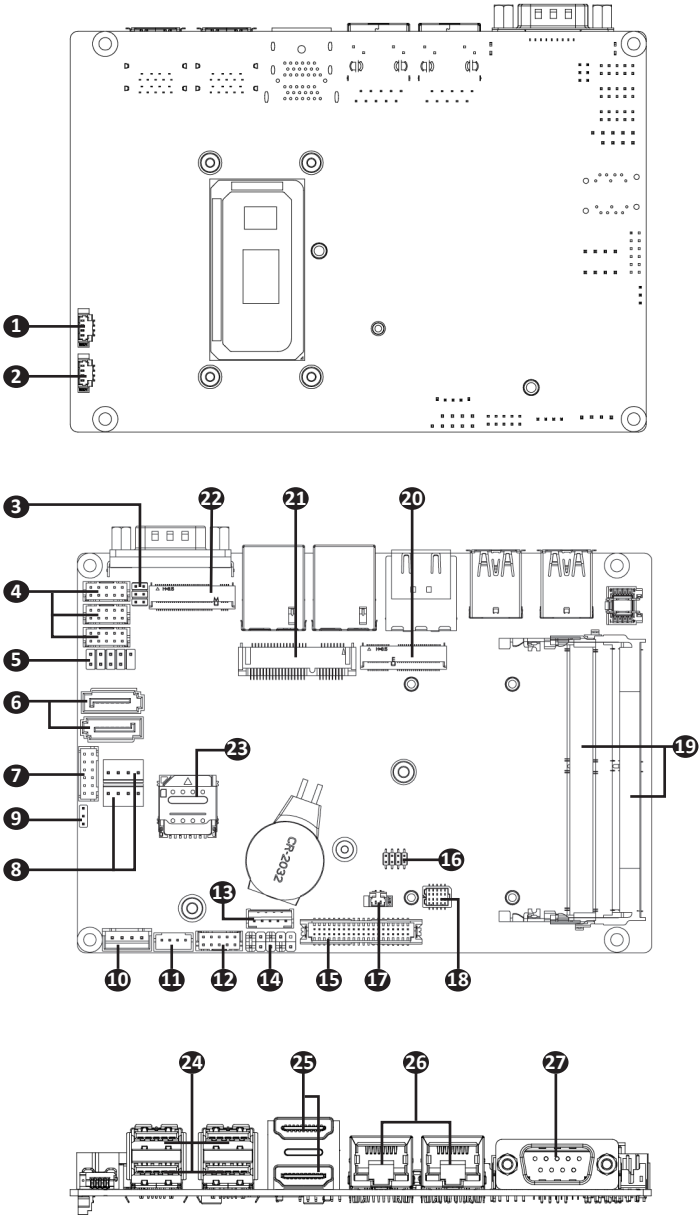

No	Code	Description
1	CPU FAN	CPU FAN connector
2	SYS FAN	System FAN connector
3	JCOM1	COM1 (COM RI# pin RI#/5V/12V Select)
4	COM2 COM3 COM4	Serial port header (RS-232)
5	FUSB	USB 2.0 header
6	SATAIII1 SATAIII0	SATA 6GB/s Connector
7	GPIO_CNT	General purpose input/output header
8	SATAPW1 SATAPW2	SATA power connector
9	AT_CN	AT/ATX mode select jumper
10	DC_IN	DC IN 1x4pin power connector
11	SPK_OUT	Speaker out connector
12	FP_Audio	Front Audio connector
13	BKL_CN	Backlight Control connector
14	SYS_PANEL	Front panel header
15	LVDS	LVDS connector
16	LSW	LVDS resolution jumper
17	BATTERY	Battery cable connector
18	LPC_CN	LPC Connector
19	SODIMM1 SODIMM2	DDR4 SO-DIMM Slot

No	Code	Description
20	M2E	M.2 Slot, E-key, NGFF2230, WiFi & Bluetooth module
21	MPCIE	Mini PCIe full size, support 3G/4G module
22	M2M	M.2 Slot, SATA/PCIe x4, NGFF2280
23	SIM-CARD	SIM Card slot
24	RUSB31_1 RUSB31_2	USB 3.2 Gen 2x1 Connector x 4
25	HDMI21	HDMI connector
26	LAN1, LAN2	LAN connector
27	COM1	Serial Port connector (RS-232/422/485 & RI/5V/12V)

## 3.2.1 CPU FAN (CPU FAN connector)

1

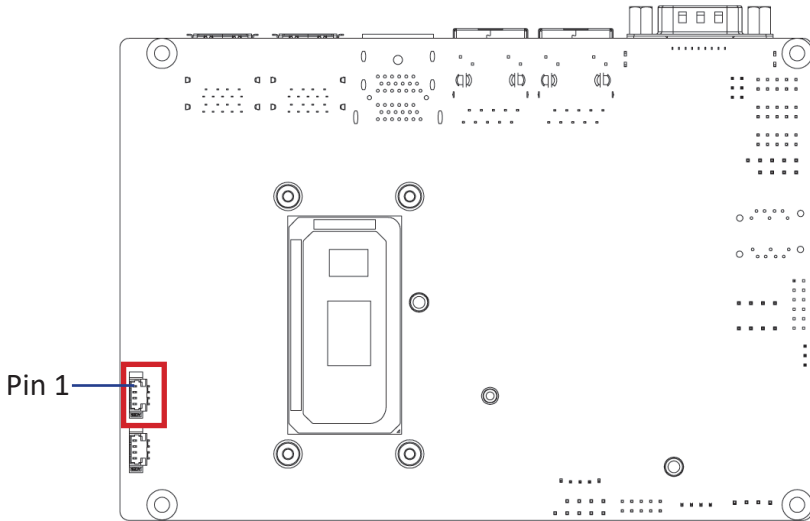

Pin 1

CPU FAN connector



Connector PN	Vendor
85205-0470N	ACES
A1250WV-S-04PC	JOINT-TECH

Pin No.	Definition
1	GND
2	12V
3	Detect
4	Speed Control

## 3.2.2 System FAN (System FAN connector)

2

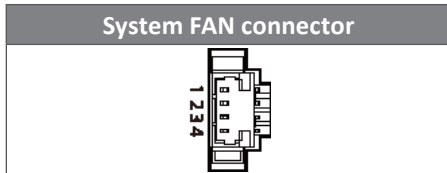
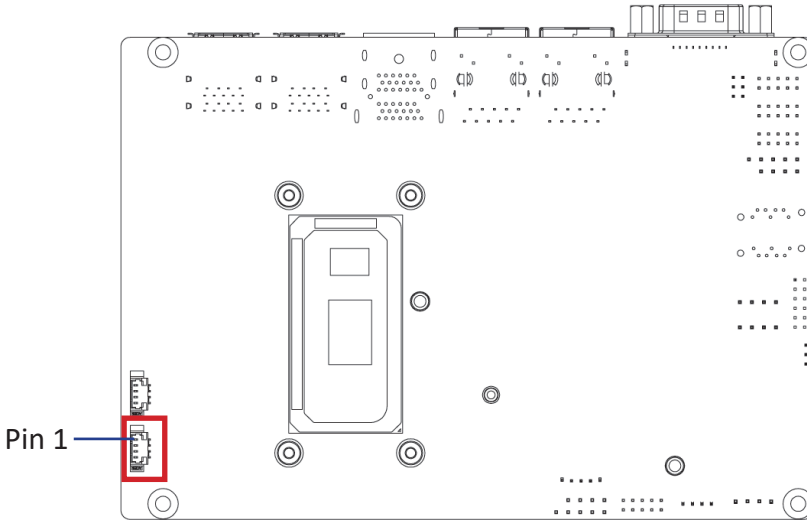





Connector PN	Vendor
85205-0470N	ACES
A1250WV-S-04PC	JOINT-TECH

Pin No.	Definition
1	GND
2	12V
3	Detect
4	Speed Control

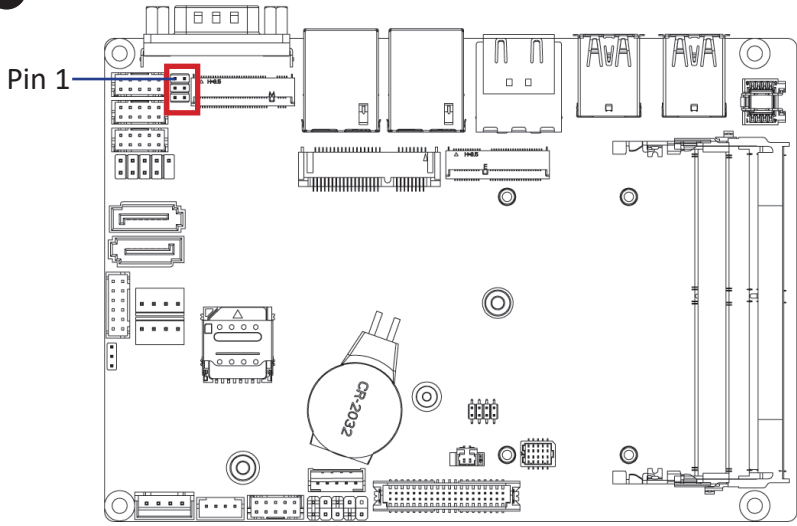
## 3.2.3 JCOM1 (COM1 RI# pin RI#/5V/12V Select)

3



JCOM11 Jumper Select	
	1-2 Close: 5V (Power COM)
	3-4 Close: RI (Stand COM) (Default-Setting)
	5-6 Close: 12V (Power COM)

Connector PN	Vendor
220-97-03GB01	PINREX
PH06N53BAZ000	HORNGTONG



### 3.2.4 COM2, COM3, COM4 (Serial port header, RS-232)

4

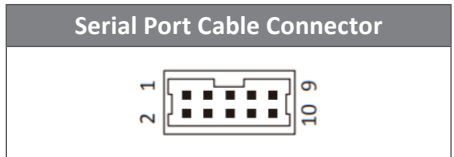
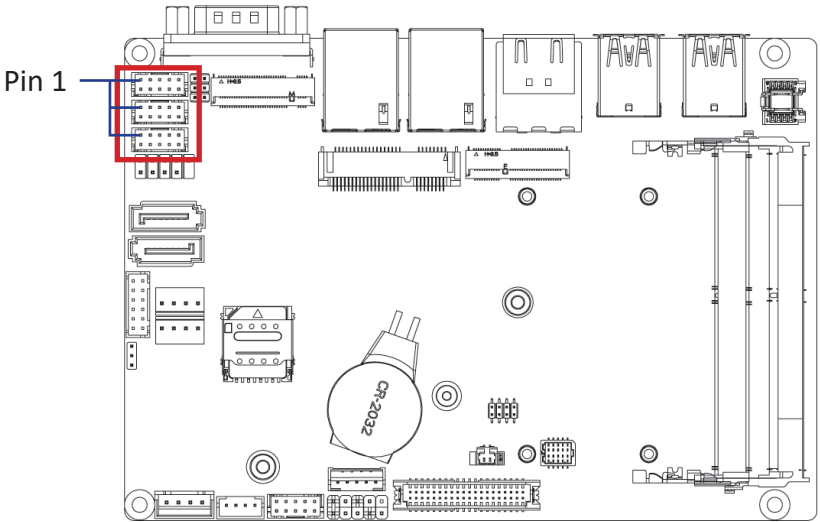

Connector PN	Vendor
725-81-10TW00	PINREX
A2004WV-2X05P46	JOINT-TECH

Pin No.	Definition
1	RXD
2	DCD
3	DTR
4	TXD
5	DSR
6	GND
7	CTS
8	RTS
9	No Connect
10	RI

## 3.2.5 FUSB (USB 2.0 header)

5

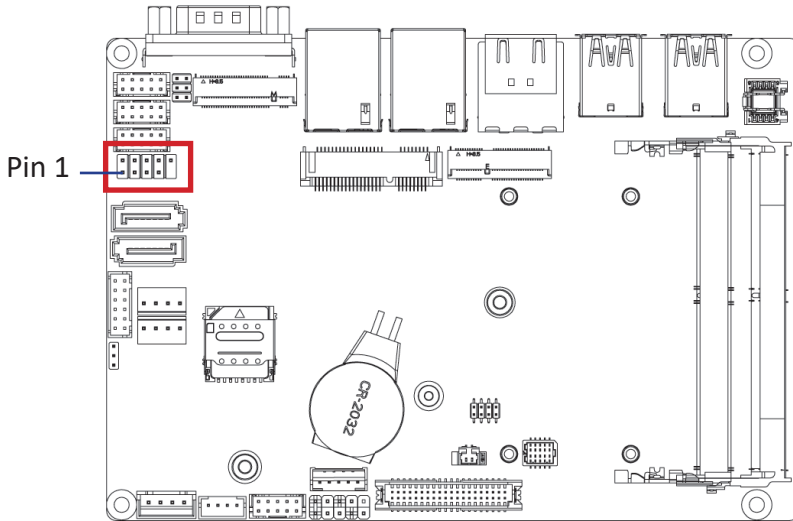

USB 2.0 Header

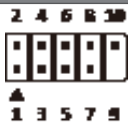

Connector PN	Vendor
210-92-05GB04	PINREX
PH10R53BAZ009	HORNGTONG

Pin No.	Definition
1	5V
2	5V
3	DX-
4	DY-
5	DX+
6	DY+
7	GND
8	GND
9	No Pin
10	No Connect

### 3.2.6 SATAIII\_0, SATAIII\_1 (SATA 6Gb/s Connector)

6

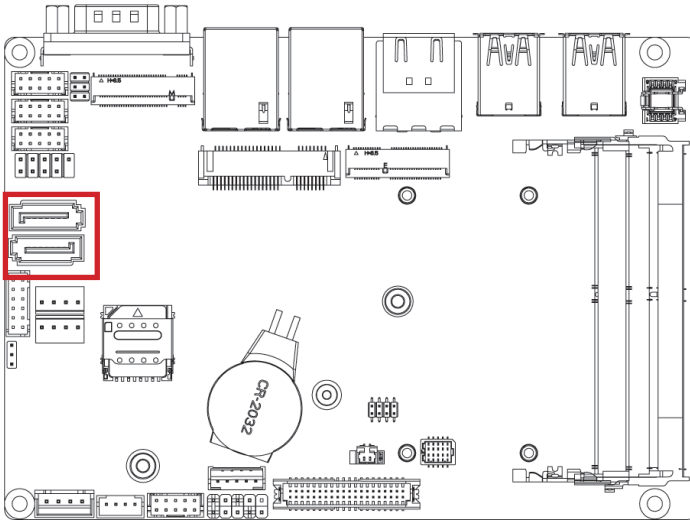

SATA Connector	
↙	↘
↘	↙

SATAIII_1,SATAIII_0	
Connector PN	Vendor
WATM-07ABNB2BAUW3	WINWIN
770-83-07SW19	PINREX

Pin No.	Definition
1	GND
2	TXP
3	TXN
4	GND
5	RXN
6	RXP
7	GND

## 3.2.7 GPIO\_CNT (General Purpose input/output header)

7

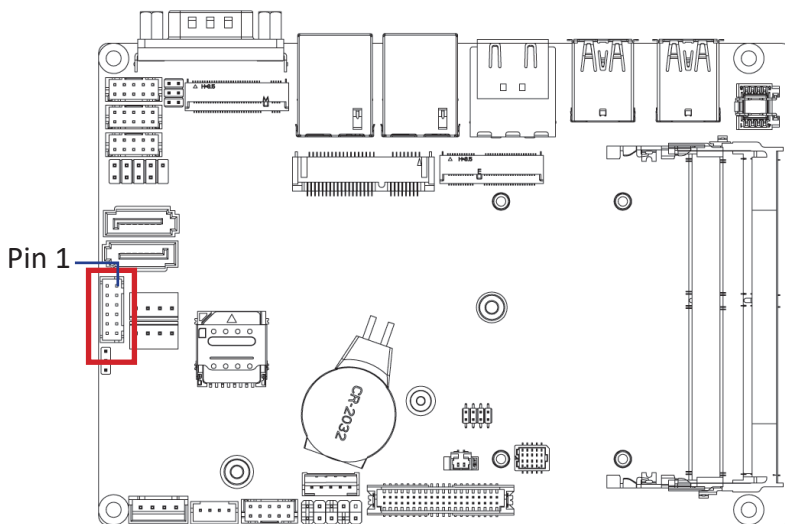

GPIO Connector

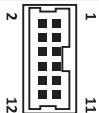

Connector PN

725-81-12TW00

A2004WV-2X06P46

Vendor

PINREX

JOINT-TECH

Pin No.

Definition

1	GPIO-output_1
2	GPIO-input_1
3	GPIO-output_2
4	GPIO-input_2
5	GPIO-output_3
6	GPIO-input_3
7	GPIO-output_4
8	GPIO-input_4
9	SMBus Clock
10	SMBus DATA
11	5V
12	GND

### 3.2.8 SATAPW1, SATAPW2 (SATA power connector)

8

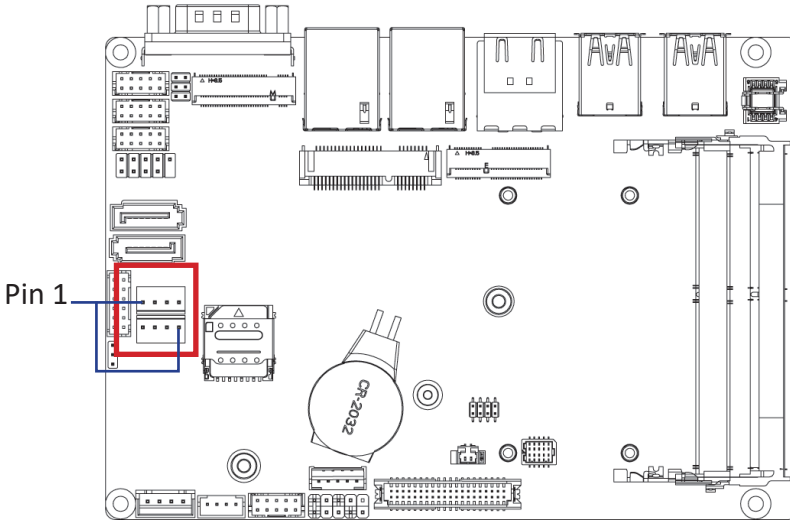

Hard Disk Power Connector



Connector PN

Vendor

743-81-04TW00

PINREX

WF04Q2-3BJQ000

HORNGTONG

Pin No.

Definition

1

12V

2

GND

3

GND

4

5V

## 3.2.9 AT\_CN (AT/ATX mode select jumper)

9

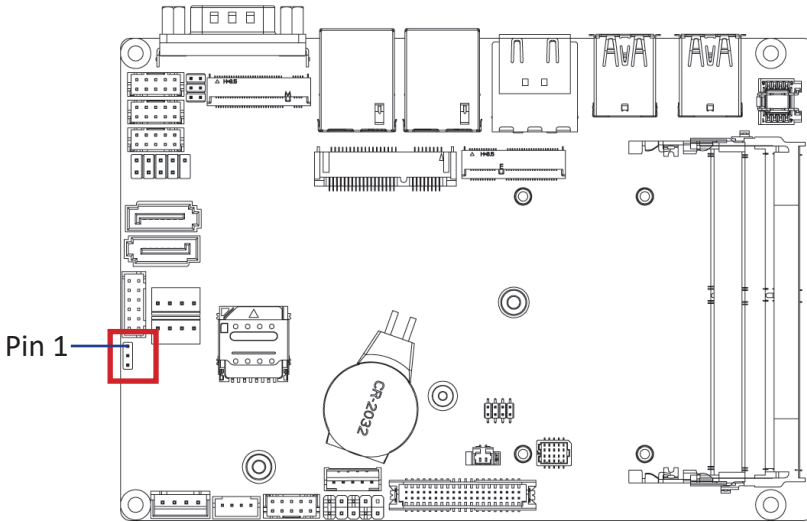

AT/ATX mode select jumper



Connector PN

220-96-03GB01

Vendor

PINREX

PH03N2-7BAN000

HORNGTONG

Pin No.	Definition
1	AT MODE
2	TXD5
3	ATX MODE

Jumper setting

1-2 Close : AT mode.

2-3 Close : ATX mode.(Default setting)

### 3.2.10 DC\_IN (DC IN 1x4-pin power connector)

10

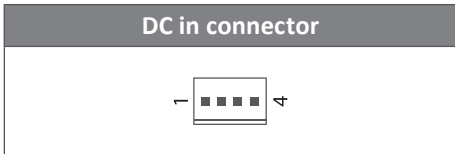
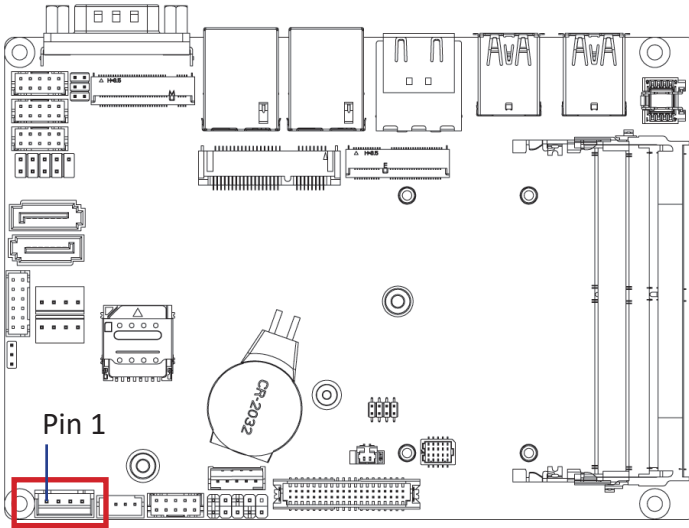

Connector PN	Vendor
753-81-04TW00	PINREX

Pin No.	Definition
1	GND
2	Power
3	Power
4	GND

## 3.2.11 SPK\_OUT (Speaker out connector)

11

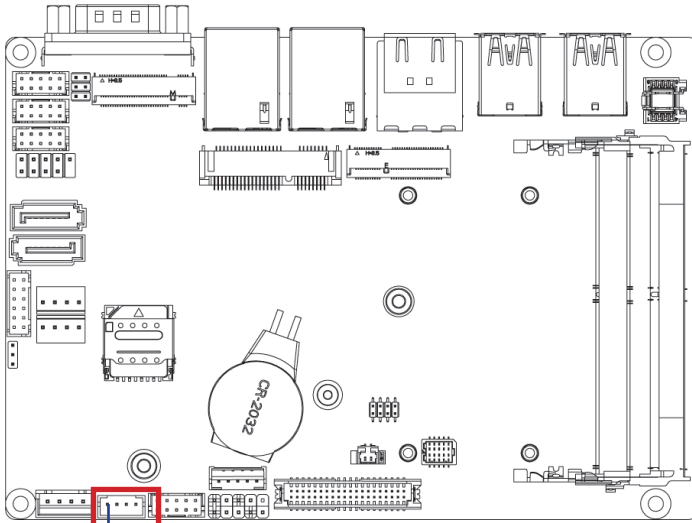

Pin 1

### Audio Amplifie Connector



**1**

### Connector PN

721-81-045W00

A2001WV-04P146

### Vendor

PINREX

JOINT-TECH

### Pin No.

### Definition

1	Speaker Out L+
2	Speaker Out L-
3	Speaker Out R-
4	Speaker Out R+



### 3.2.12 FP\_Audio (Front Audio connector)

12

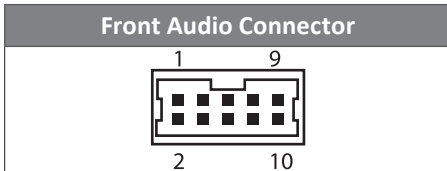
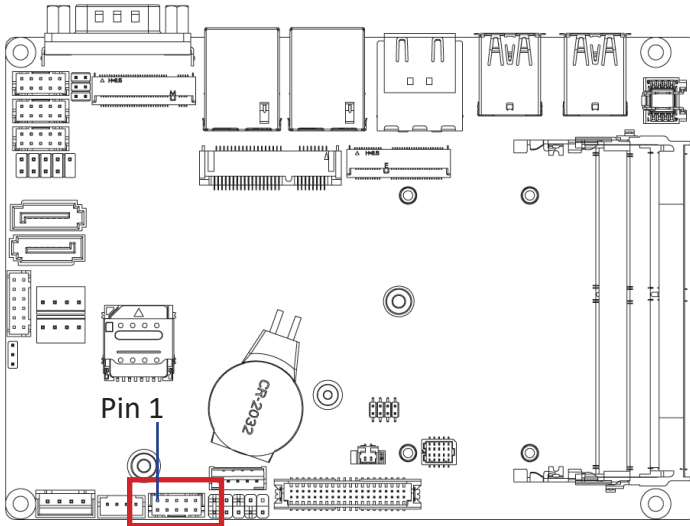

Connector PN	Vendor
725-81-10TW00	PINREX
A2004WV-2X05P46	JOINT-TECH

Pin No.	Definition
1	MIC_L
2	GND
3	MIC_R
4	Detect
5	HPOUT_R
6	MIC_JD
7	FAUDIO_JD
8	No Connect
9	HPOUT_L
10	GND

## 3.2.13 BKL\_CN (Backlight Control connector)

13

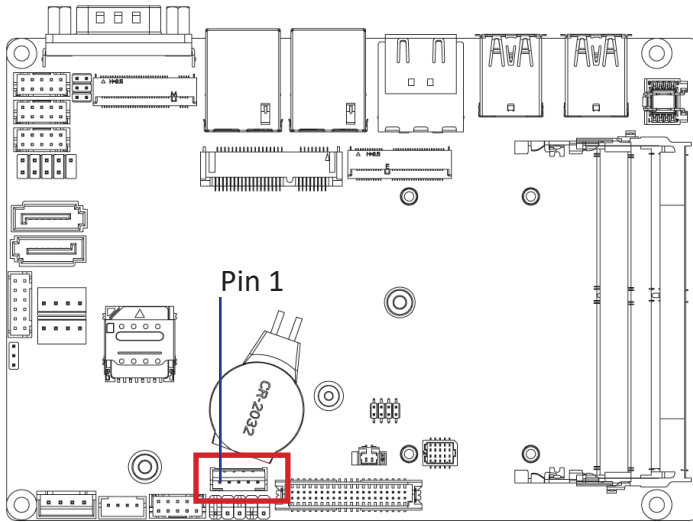

Backlight Control connector



Connector PN

721-81-05TW00

Vendor

PINREX

A2001WV-05P146

JOINT-TECH

Pin No.

Definition

1

5V

2

PWM

3

Backlight Enable

4

GND

5

12V

### 3.2.14 SYS\_PANEL (Front panel header)

14

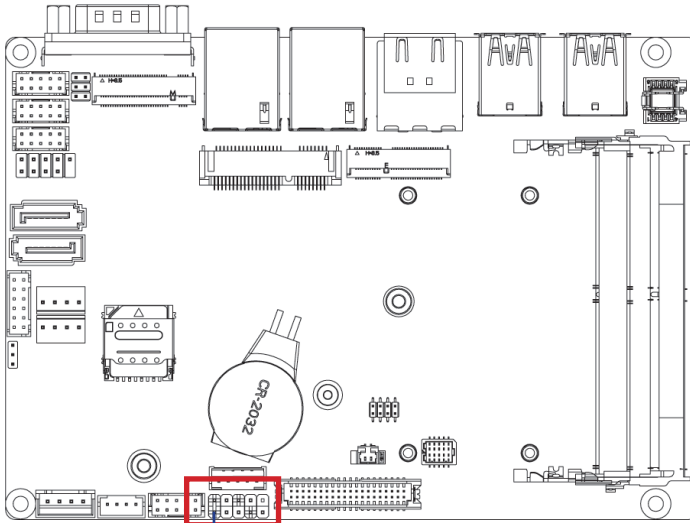

Pin 1

System Panel Header	
2	10
1	9

Connector PN	Vendor
210-92-05G111	PINREX

Pin No.	Definition
1	HDD LED+
2	Power LED+
3	HDD LED-
4	Power LED-
5	GND
6	Power Button+
7	Reset Button
8	Power Button-
9	No Connect
10	No Pin

## 3.2.15 LVDS (LVDS connector)

15

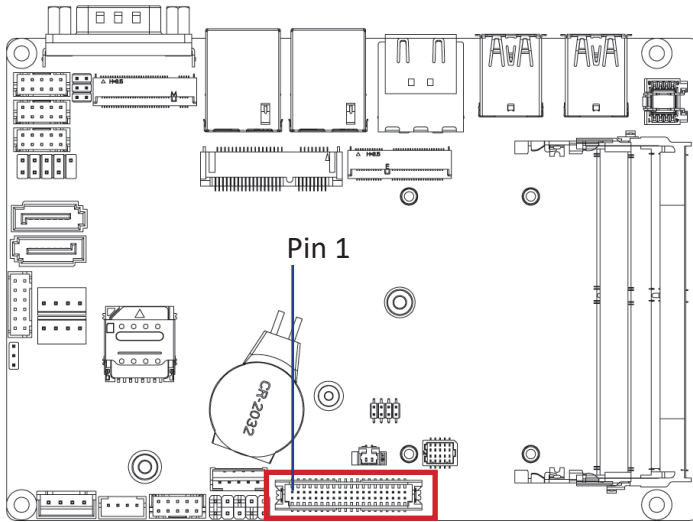

LVDS Connector

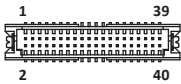

Pin No.	Definition	Pin No.	Definition
1	3.3V	21	A5+
2	5V	22	A4+
3	3.3V	23	A5-
4	5V	24	A4-
5	SPECO	25	GND
6	SPEDO	26	GND
7	GND	27	A7+
8	GND	28	A6+
9	A1+	29	A7-
10	A0+	30	A6-
11	A1-	31	GND
12	A0-	32	GND
13	GND	33	CLK2+
14	GND	34	CLK1+
15	A3+	35	CLK2-
16	A2+	36	CLK1-
17	A3-	37	GND
18	A2-	38	GND
19	GND	39	12V
20	GND	40	12V

Connector PN

Vendor

712-76-40GWEO	PINREX
A1252WV-SF-2X20PD01	JOINT-TECH

For each model support LVDS function.  
But below model no need to add.  
A0~A3 is odd channel 0~3, A4~A7 is ev en channel.

Note: \*The LVDS output connector of the unit is only intended to be connected to an UL/IEC/EN approval equipment with fire enclosure.

### 3.2.16 LSW (LVDS resolution jumper)

16

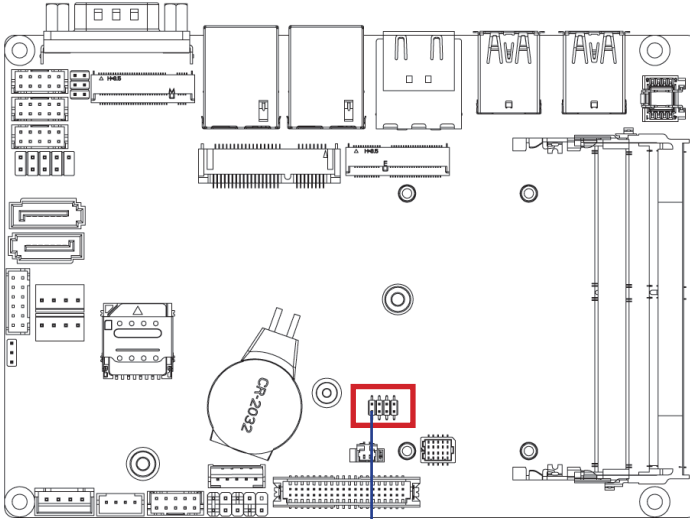

Pin 1

LVDS Resolution Jumper			
Jumper Setting	Resolution	Jumper Setting	Resolution
	800 x 600 18bit		1366 x 768 24bit
	1024 x 768 18bit		1440 x 900 24bit
	1024 x 768 24bit		1400 x 1050 24bit
	1024 x 600 18bit		1600 x 900 24bit
	1280 x 800 18bit		1680 x 1050 24bit
	1280 x 960 18bit		1600 x 1200 24bit
	1280 x 1024 24bit		1920 x 1080 24bit
	1366 x 768 18bit		1920 x 1200 24bit

Connector PN	Vendor
222-97-04GBE1	PINREX

## 3.2.17 BATTERY (Battery cable connector)

17

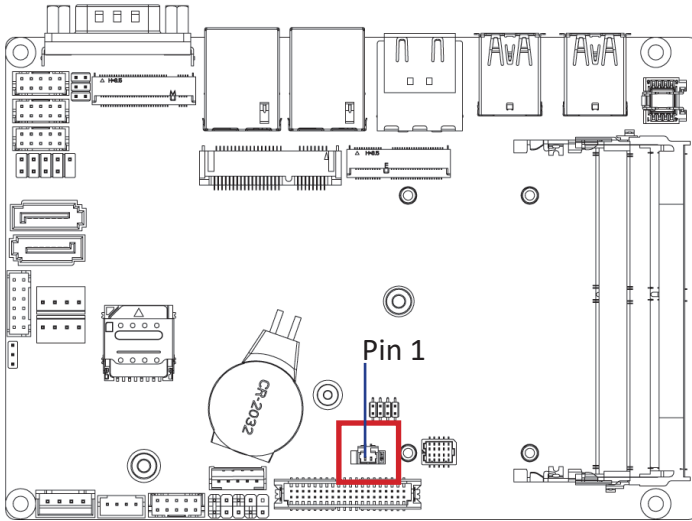

**Battery Cable Connector**

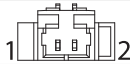

**Connector PN**

85205-0270L  
A1250WV-S-02PC

**Vendor**

ACES  
JOINT-TECH

**Pin No.**      **Definition**

1	3.3V
2	GND

### 3.2.18 LPC\_CN (LPC Connector)

18

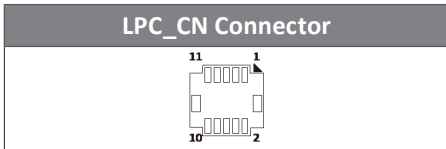
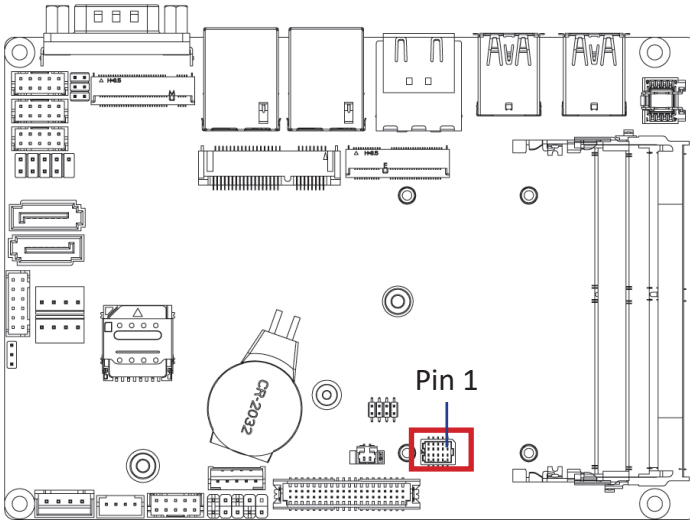

Pin No.	Definition
1	CK_LPC1
2	GND
3	LFRAME#
4	LAD0
5	PLT_RST_80H
6	LAD1
7	LAD3
8	LAD2
9	3.3V
10	SERIRQ

## 3.2.19 SODIMM1, SODIMM2 (DDR4 SO-DIMM Slot)

19

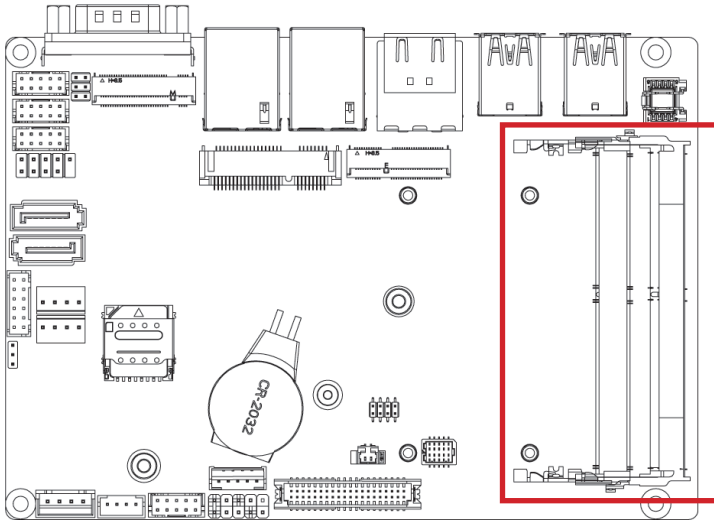



### 3.2.20 M2E (M.2 Slot, E-Key, NGFF2230, WiFi & Bluetooth module)

20

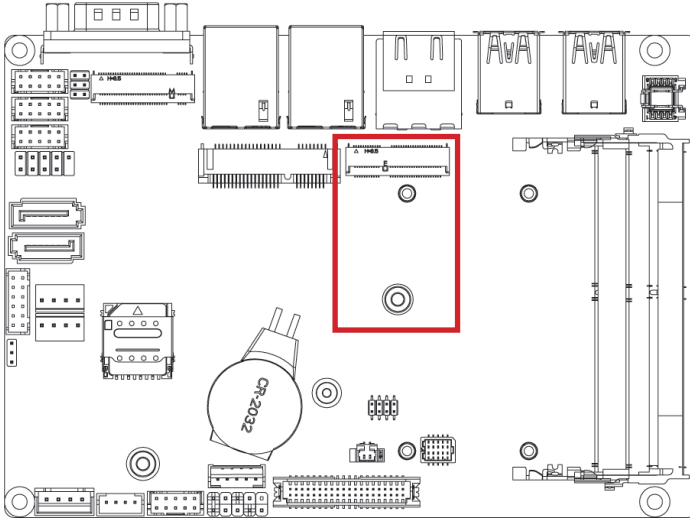

**M.2 E Key Connector**



Pin No.	Definition	Pin No.	Definition
1	GND	2	3V
3	USB_D+	4	3V
5	USB_D-	6	NC
7	GND	8	NC
9	NC	10	NC
11	NC	12	NC
13	NC	14	NC
15	NC	16	NC
17	NC	18	GND
19	NC	20	BT_WAKE
21	NC	22	NC
23	NC		

Pin No.	Definition	Pin No.	Definition
33	GND	32	NC
35	WLAN_TXp	34	NC
37	WLAN_TXn	36	NC
39	GND	38	CL_RST#

41	WLAN_RXp	40	CL_DATA
43	WLAN_RXn	42	CL_CLK
45	GND	44	NC
47	CLK_DP	46	NC
49	CLK_DN	48	NC
51	GND	50	SUSCLK
53	CLK_REQ	52	PLT_RST#
55	PCIE_WAKE	54	BT_Disable#
57	GND	56	WIFI_Disable#
59	NC	58	NC
61	NC	60	NC
63	GND	62	NC
65	NC	64	NC
67	NC	66	NC
69	GND	68	NC
71	NC	70	NC
73	NC	72	3V
75	GND	74	3V

Connector PN	Vendor
APCI0095-P002A	LOTES
80152-8521	BELLWETHER

## 3.2.21 MPCIE (Mini PCIe full size, support 3G/4G module)

21

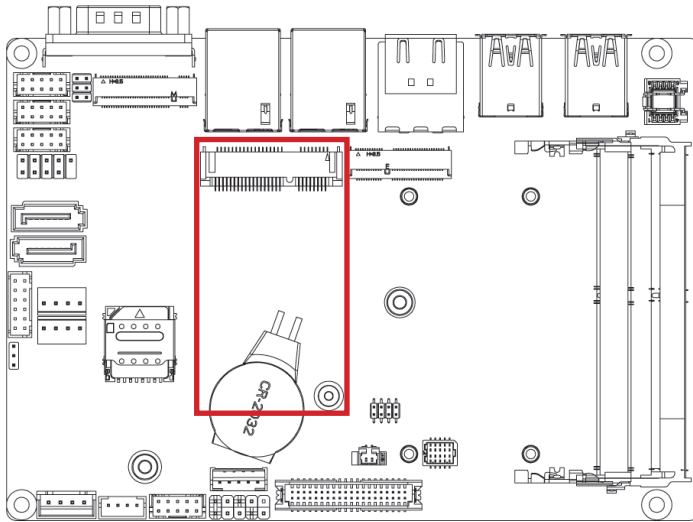

Mini PCIe Connector

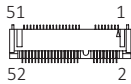

Pin No.	Definition	Pin No.	Definition
1	PCIE_WAKE#	2	3.3V
3	NC	4	GND
5	NC	6	1.5V
7	PCIE_CLKREQ#	8	SIM_PWR
9	GND	10	SIM_DATA
11	PCIE_CLK#	12	SIM_CLK
13	PCIE_CLK	14	SIM_RST
15	GND	16	SIM_VPP
17	NC	18	GND
19	NC	20	PCIE_DISABLE
21	GND	22	PCIRST#
23	PCIE_RXn	24	3.3V
25	PCIE_RXp	26	GND
27	GND	28	1.5V
29	GND	30	SMBCLK
31	PCIE_TXn	32	SMBDATA
33	PCIE_TXp	34	GND

35	GND	36	USB-
37	GND	38	USB+
39	3.3V	40	GND
41	3.3V	42	NC
43	GND	44	NC
45	NC	46	NC
47	NC	48	1.5V
49	NC	50	GND
51	NC	52	3.3V

Connector PN	Vendor
AS0B221-S99Q-7H	FOXCONN

## 3.2.22 M2M (M.2 Slot, SATA/PCIe x4, NGFF2280)

22

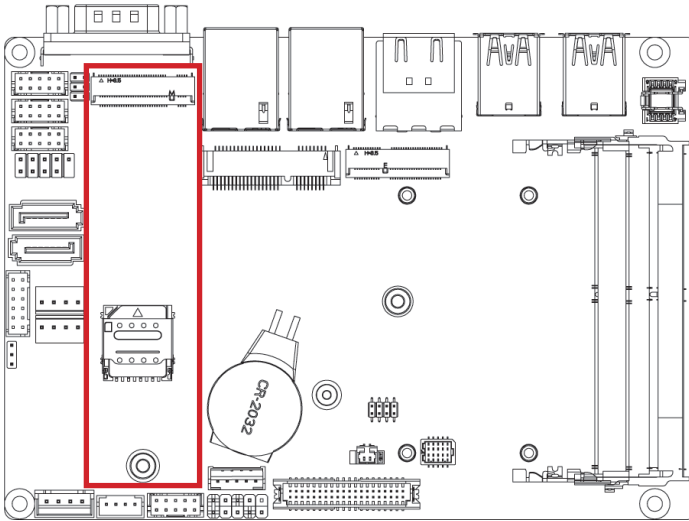

### M.2 M Key Connector



Pin No.	Definition	Pin No.	Definition
1	GND	2	3.3V
3	GND	4	3.3V
5	NC	6	NC
7	NC	8	NC
9	GND	10	M2_LED
11	NC	12	3.3V
13	NC	14	3.3V
15	GND	16	3.3V
17	NC	18	3.3V
19	NC	20	NC
21	GND	22	NC
23	NC	24	NC
25	NC	26	NC
27	GND	28	NC
29	PCIe_RXn	30	NC
31	PCIe_RXp	32	NC
33	GND	34	NC
35	PCIe_TXn	36	NC

Pin No.	Definition	Pin No.	Definition
37	PCIe_TXp	38	DEVSLP
39	GND	40	SMB Clock
41	SATA_RXp	42	SMB DATA
43	SATA_RXn	44	SMB ALERT
45	GND	46	NC
47	SATA_TXn	48	NC
49	SATA_TXp	50	PLT_RST
51	GND	52	CK_REQ
53	CLK_n	54	PCIe_WAKE#
55	CLK_p	56	NC
57	GND	58	NC

Pin No.	Definition	Pin No.	Definition
67	NC	68	SUSCLK
69	M2_SSD_Detect	70	3.3V
71	GND	72	3.3V
73	GND	74	3.3V
75	GND		

Connector PN	Vendor
80159-8521	BELLWETHER

## 3.2.23 SIM\_CARD (SIM Card slot)

23

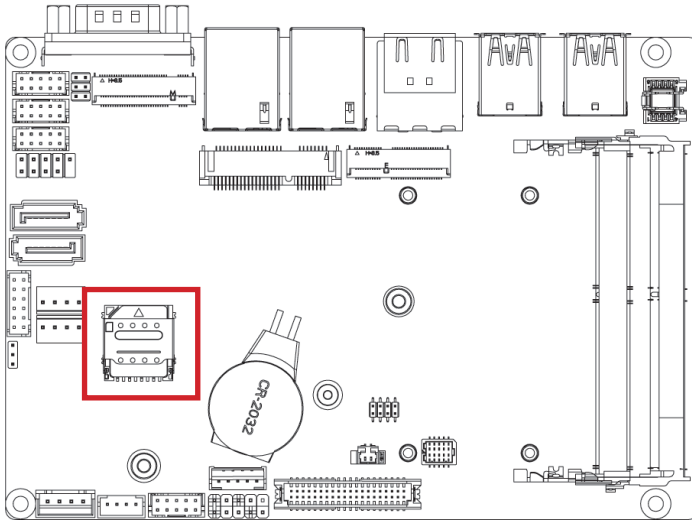

### 3.2.24 RUSB31\_1, RUSB31\_2 (USB 3.2 Gen 2x1 connector)

24

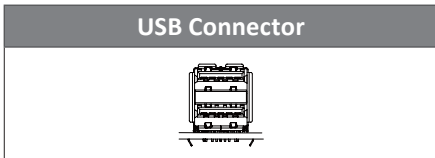
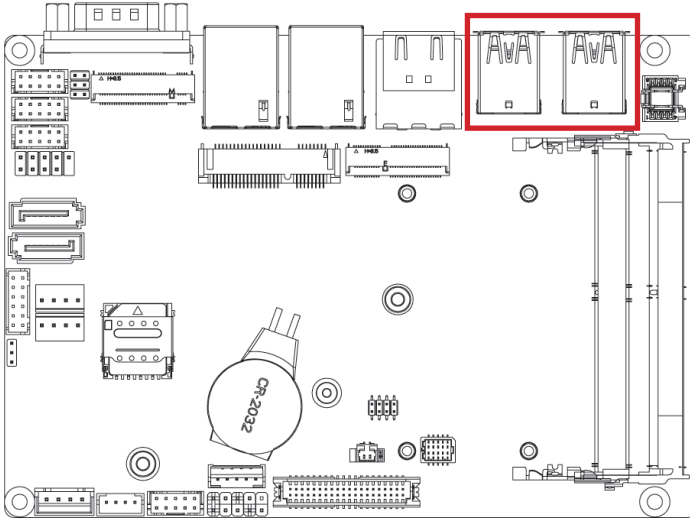

Connector PN	Vendor
UAA111C-841R1-4H	FOXCONN

Pin No.	Definition	Pin No.	Definition
1	5V	10	5V
2	USB_D-	11	USB_D-
3	USB_D+	12	USB_D+
4	GND	13	GND
5	USB3_RX-	14	USB3_RX-
6	USB3_RX+	15	USB3_RX+
7	GND	16	GND
8	USB3_TX-	17	USB3_TX-
9	USB3_TX+	18	USB3_TX+

## 3.2.25 HDMI21 (HDMI connector)

25

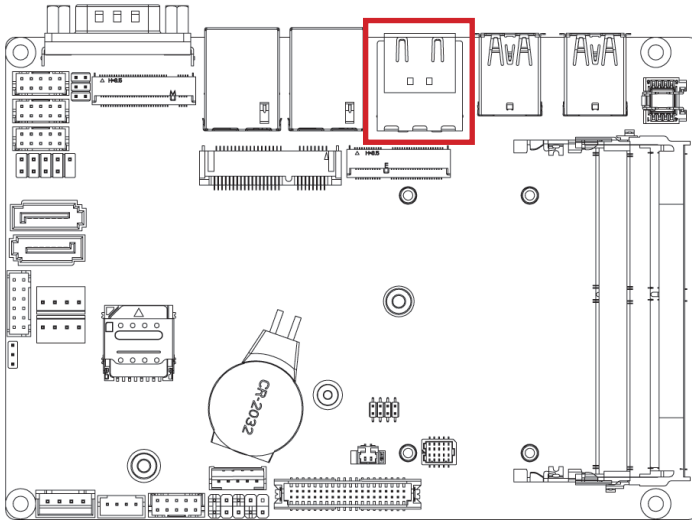

HDMI Connector



Connector PN

QJ11191-DFB1-4F

Vendor

FOXCONN

Pin No.	Definition	Pin No.	Definition
1	HDMI_D2+	13	NC
2	GND	14	NC
3	HDMI_D2-	15	HDMI_SCL
4	HDMI_D1+	16	HDMI_SDA
5	GND	17	GND
6	HDMI_D1-	18	5V
7	HDMI_D0+	19	HDMI_HPD
8	GND		
9	HDMI_D0-		
10	HDMI_CLK+		
11	GND		
12	HDMI_CLK-		

### 3.2.26 LAN1, LAN2 (LAN connector)

26

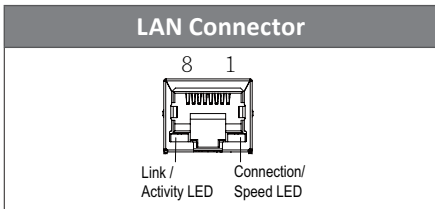
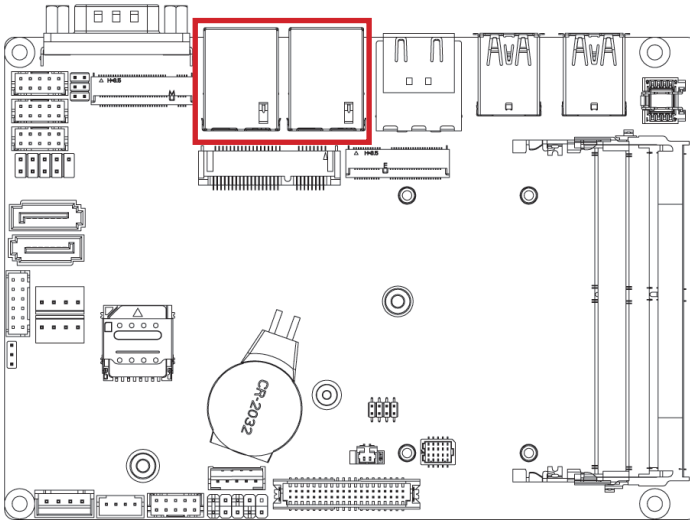

State	Description
Orange On	1Gbps data rate
Green On	100Mbps data rate
Off	10Mbps data rate

Pin No.	Definition
1	TX1+
2	TX1-
3	TX2+
6	TX2-
4	TX3+
5	TX3-
7	TX4+
8	TX4-

Connector PN	Vendor
RB1-13NB5N5A	UDE

## 3.2.27 COM1 (Serial port connector, RS-232/422/485 & RI/5V/12V)

3.5" SBC Boards

QBIP-8565A/ QBIP-8265A/ QBIP-8145A

27

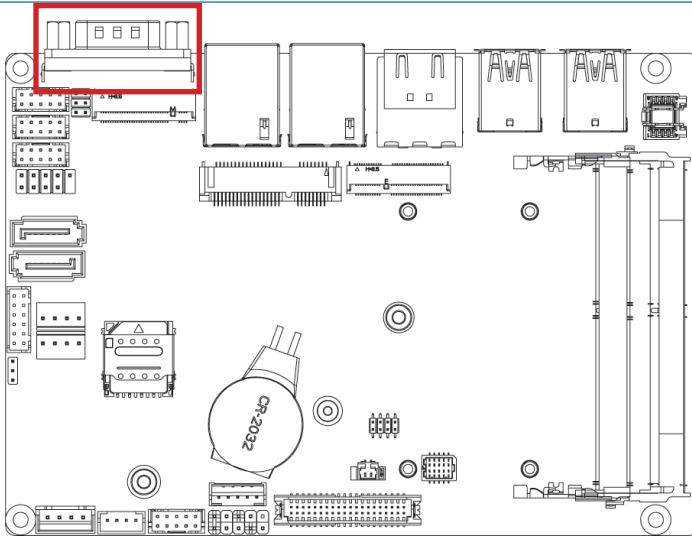

Serial Port Connector

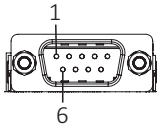

Connector PN	Vendor
SM41D1P1122N33N1	FENYING

Pin No.	RS-232	RS-422 Full Duplex	RS-485 Half Duplex
1	DCD	TXD-	D-
2	RXD	TXD+	D+
3	TXD	RXD+	-
4	DTR	RXD-	-
5	GND		
6	DSR	-	-
7	RTS	-	-
8	CTS	-	-
9	RI	-	-



