

QBiX-Pro-BYTA1900HD-A1 (QP-1900B-SI)

QBiX-Pro Industrial Embedded System
Quick Start Guide

Copyright Notice

This document is copyrighted, 2022. All rights are reserved. The original manufacturer reserves the right to make improvements to the products described in this manual at any time without notice.

No part of this manual may be reproduced, copied, translated, or transmitted in any form or by any means without the prior written permission of the original manufacturer. Information provided in this manual is intended to be accurate and reliable. However, the original manufacturer assumes no responsibility for its use, or for any infringements upon the rights of third parties that may result from its use.

The material in this document is for product information only and is subject to change without notice. While reasonable efforts have been made in the preparation of this document to assure its accuracy, GIGAIPC assumes no liabilities resulting from errors or omissions in this document, or from the use of the information contained herein.

GIGAIPC reserves the right to make changes in the product design without notice to its users.

Acknowledgement

All other products' name or trademarks are properties of their respective owners.

- AMD is trademark of Advanced Micro Devices.
- Microsoft Windows is a registered trademark of Microsoft Corp.
- Intel, Pentium, Celeron, and Xeon are registered trademarks of Intel Corporation
- Core, Atom are trademarks of Intel Corporation
- ITE is a trademark of Integrated Technology Express, Inc.
- IBM, PC/AT, PS/2, and VGA are trademarks of International Business Machines Corporation.

All other product names or trademarks are properties of their respective owners.

Packing List

Before setting up your product, please make sure the following items have been shipped:

Item	Quantity
System kit	1
HDD screw, M3x4L	4
Dehydrate (10G)	1
Terminal Blocks 1*3P	1
Terminal Blocks 1*10P	1

If any of these items are missing or damaged, please contact your distributor or sales representative immediately.

About this Document

This User's Manual contains all the essential information, such as detailed descriptions and explanations on the product's hardware and software features (if any), its specifications, dimensions, jumper/connector settings/definitions, and driver installation instructions (if any), to facilitate users in setting up their product.

Users may refer to the GIGAIPC.com for the latest version of this document.

Safety Precautions

Please read the following safety instructions carefully. It is advised that you keep this manual for future references

1. All cautions and warnings on the device should be noted.
2. Make sure the power source matches the power rating of the device.
3. Position the power cord so that people cannot step on it. Do not place anything over the power cord.
4. Always completely disconnect the power before working on the system's hardware.
5. No connections should be made when the system is powered as a sudden rush of power may damage sensitive electronic components.
6. If the device is not to be used for a long time, disconnect it from the power supply to avoid damage by transient over-voltage.
7. Always disconnect this device from any AC supply before cleaning.
8. While cleaning, use a damp cloth instead of liquid or spray detergents.
9. Make sure the device is installed near a power outlet and is easily accessible.
10. Keep this device away from humidity.
11. Place the device on a solid surface during installation to prevent falls
12. Do not cover the openings on the device to ensure optimal heat dissipation.

13. Watch out for high temperatures when the system is running.
14. Do not touch the heat sink or heat spreader when the system is running
15. Never pour any liquid into the openings. This could cause fire or electric shock.
16. As most electronic components are sensitive to static electrical charge, be sure to ground yourself to prevent static charge when installing the internal components. Use a grounding wrist strap and contain all electronic components in any static-shielded containers.
17. If any of the following situations arises, please the contact our service personnel:
 - i. Damaged power cord or plug
 - ii. Liquid intrusion to the device
 - iii. Exposure to moisture
 - iv. Device is not working as expected or in a manner as described in this manual
 - v. The device is dropped or damaged
 - vi. Any obvious signs of damage displayed on the device
- 18. DO NOT LEAVE THIS DEVICE IN AN UNCONTROLLED ENVIRONMENT WITH TEMPERATURES BEYOND THE DEVICE'S PERMITTED STORAGE TEMPERATURES (SEE CHAPTER 1) TO PREVENT DAMAGE.**

FCC Statement

Warning!



This device complies with Part 15 FCC Rules. Operation is subject to the following two conditions: (1) this device may not cause harmful interference, and (2) this device must accept any interference received including interference that may cause undesired operation.

Caution:

There is a danger of explosion if the battery is incorrectly replaced. Replace only with the same or equivalent type recommended by the manufacturer. Dispose of used batteries according to the manufacturer's instructions and your local government's recycling or disposal directives.

Attention:

Il y a un risque d'explosion si la batterie est remplacée de façon incorrecte. Ne la remplacer qu'avec le même modèle ou équivalent recommandé par le constructeur. Recycler les batteries usées en accord avec les instructions du fabricant et les directives gouvernementales de recyclage.

Table Contents

QBiX-Pro Industrial Embedded System	1
Quick Start Guide	
Copyright Notice	2
Acknowledgement	3
Packing List.....	4
About this Document	5
Safety Precautions	6
FCC Statement.....	8
Chapter 1 - Product Specifications	12
1.1 Specifications	14
Chapter 2 – QBiX-Pro-BYTA1900HD-A1	16
(QP-1900B-SI) Industrial Embedded System Kit	
2.1 Dimension	17
2.2 Getting Familiar with Your Unit.....	18
2.3 Memory Installation: DDR3L SO-DIMM	20
2.4 Antenna Installation (Antenna inclusion may vary based on local distribution)	21
2.5 Din Rail Bracket Installation	22
2.6 HDD Installation	23
2.7 Cable Pin-define	24
2.8 Support	25
2.9 Safety and Regulatory Information.....	26

Chapter 3 – Hardware Information	27
3.1 Jumpers and Connectors	28
3.2.1 BATTERY	31
3.2.2 LVDS (LVDS connector).....	32
3.2.3 LSW (LVDS resolution jumper)	33
3.2.4 BKL_CN (Backlight brightness control connector).....	34
3.2.5 SODIMM (DDR3L SO-DIMM).....	35
3.2.6 BUZZER.....	36
3.2.7 FUSB20_1, FUSB2_2 (USB 2.0 header).....	37
3.2.8 SATA (SATA 3 Gb/s Connector)	38
3.2.9 SATAPW (SATA power connector)	39
3.2.10 GPIO_CNT (General Purpose input/output header) ...	40
3.2.11 JCOM11 (RI# pin RI#/5V/12V Select jumper for COM1 port)	41
3.2.12 DC IN (DC IN 1x4pin power connector)	42
3.2.13 SYS_PANEL (Front panel header)	43
3.2.14 COM1, COM2, COM3, COM4 (Serial port header)	44
3.2.15 AT_CN (AT/ATX power mode select jumper)	45
3.2.16 SPK_OUT (Speaker out connector)	46
3.2.17 M2M (M.2 Slot, SATA, NGFF2280)	47
3.2.18 MPCIE (Mini PCIe slot).....	48
3.2.19 LPC_CN (LPC Connector)	49
3.2.20 FAN (FAN Connector)	50
3.2.21 LAN1, LAN2 (LAN Connector)	51
3.2.22 RUSB1, RUSB2 (USB 3.2 Gen 1 + USB 2.0 connector) ..	52

3.2.23	HDMI (HDMI Connector).....	53
3.2.24	VGA (D-sub port)	54

Chapter 4 – BIOS **55**

4.1	Introduction	56
4.2	The Main Menu.....	57
4.3	Advanced	58
4.3.1	TPM Configuration.....	59
4.3.2	IT8786 Super I/O Configuration.....	61
4.3.3	Hardware Monitor	62
4.3.4	S5 RTC Wake Settings	63
4.3.5	CPU Configuration	64
4.3.6	SATA Configuration	66
4.3.7	CSM Configuration.....	67
4.3.8	Digital IO Port Configuration	68
4.4	Chipset	69
4.5	Security	70
4.6	Boot.....	73
4.7	Save & Exit	74

Chapter 1

Chapter 1 - Product Specifications

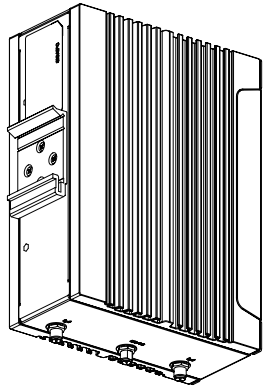
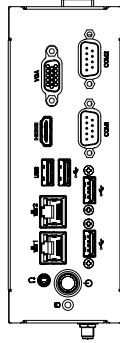
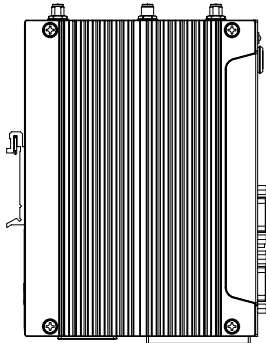
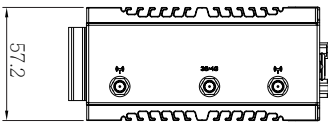
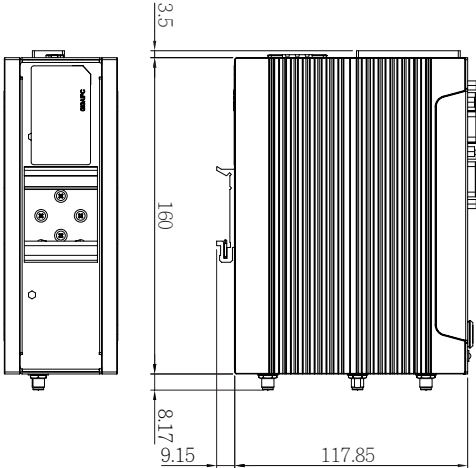
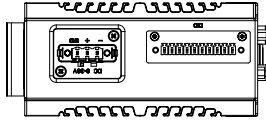

1.1 Specifications

System	QBiX-Pro-BYTA1900HD-A1 (QP-1900B-SI)
Dimension	System Size : 160W x 118D x 62.6H (mm)
CPU	Intel® Celeron® J1900 Processor 22nm, 4 cores, 4 threads, up to 2.42 GHz TDP 10W 2MB L2 cache
Chipset	SoC
Memory	1 x DDR3L SO-DIMM socket, Max. Capacity 8 GB Support Single Channel DDR3L 1333 MHz memory modules
Ethernet	2 x GbE LAN Ports (Intel® I211AT)
Graphic support	Integrated Graphics Processor -Intel® HD Graphics: 1 x HDMI 1.4 port, supporting a maximum resolution of 1920x1200 @60Hz 1 x D-sub port, supporting a maximum resolution of 2560x1600 @60Hz (with compatible displays) (2 independent display outputs)
Audio	Realtek® Audio Codec
Storage	1 x 2.5" HDD/SSD (SATA 3Gb/s)
Expansion Slots	1 x 2280 M.2 M-Key (SATA 3Gb/s) 1 x Full-size Mini PCIe with SIM slot (PCIe x1 + USB2.0) – support 3G/4G module
Front I/O	2 x RJ45 LAN Ports 1 x USB 3.2 Gen 1 3 x USB 2.0 1 x HDMI 1 x D-sub 1 x COM Port (RS-232/422/485 & RI/5V/12V) 1 x COM Port (RS-232/422/485) 1 x Power button with LED 1 x HDD LED 1 x Headphone Jack
Rear I/O	1 x Din Rail Mounting Support
Side I/O	1 x GPIO (8 bits) 1 x 3-pin Terminal Block 3 x External Antenna Holes (Optional)

System	QBiX-Pro-BYTA1900HD-A1 (QP-1900B-SI)
TPM	1 x TPM header
Power	+9V~36VDC (Full Range)
Operation temperature	Operating temperature: 0°C to 50°C Operating humidity: 0-90% (non-condensing) Non-operating temperature: -40°C to 85°C Non-operating humidity: 0%-95% (non-condensing) Use wide temperature range memory and storage
Vibration During Operation	Operation: IEC 60068-2-64, 5 Grms, random, 5 ~ 500 Hz, 1 hr / Per Axis, With SSD/M.2 2242 Non-operation: IEC 60068-2-6, 2 G, Sine, 10 ~ 500 Hz, 1 Oct/min, 1 hr / Per Axis
Shock During Operation	Operation: IEC 60068-2-27, 50 G, half sine, 11 ms duration, with SSD

Chapter 2

Chapter 2 – QBiX-Pro-BYTA1900HD-A1
(QP-1900B-SI) Industrial Embedded System Kit

2.1 Dimension

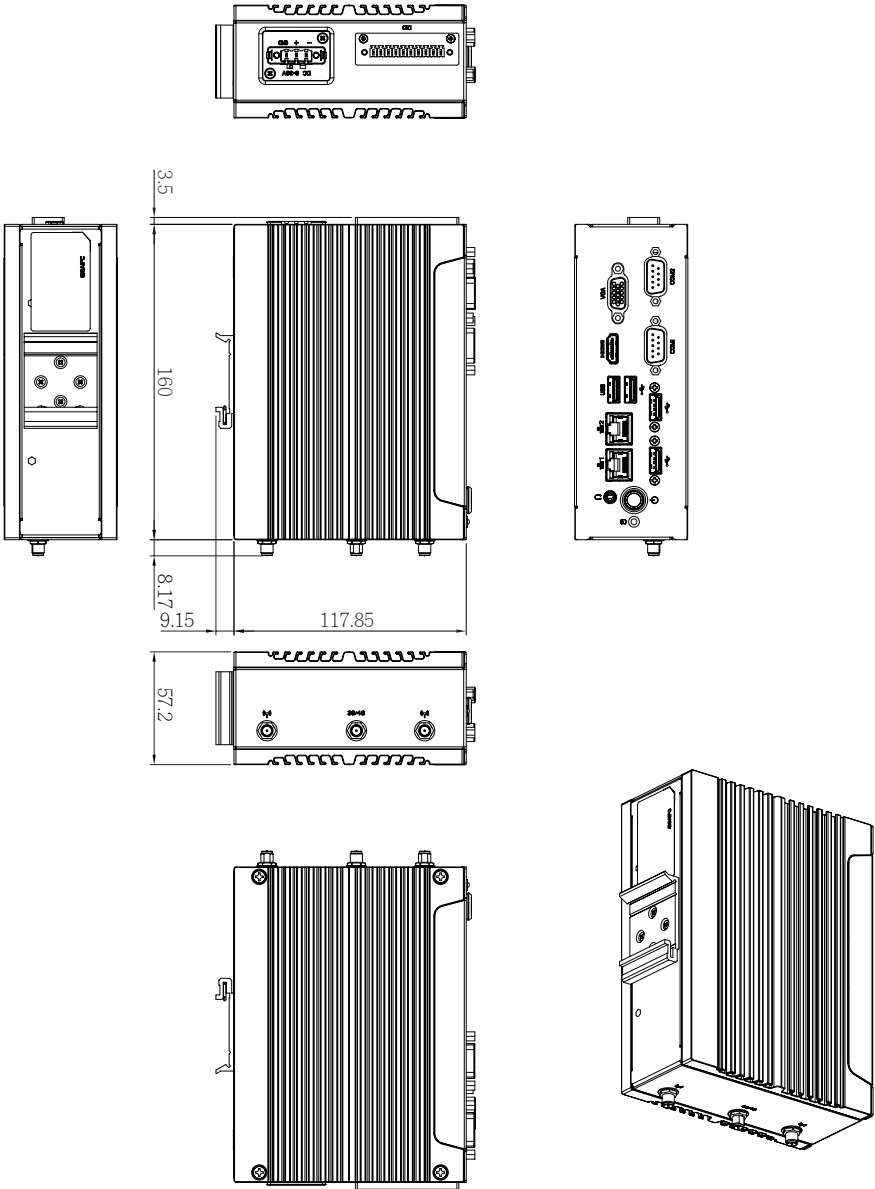

2.2 Getting Familiar with Your Unit

[Front Side]

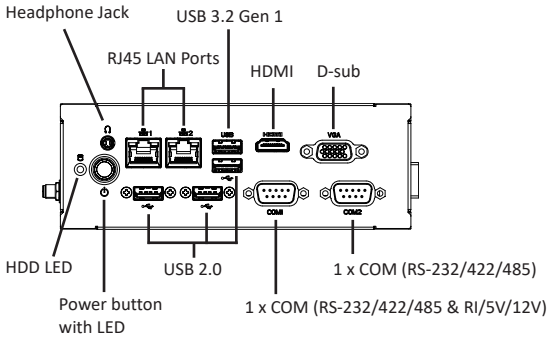

[Left Side]

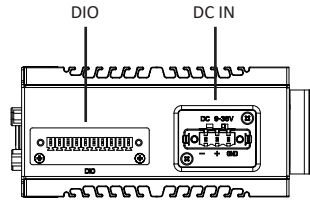

[Rear Side]

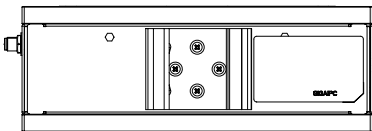

[Right Side]

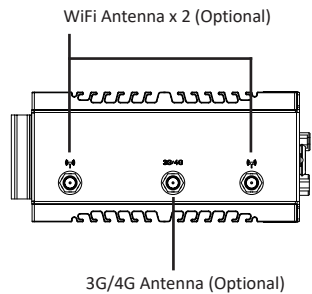

[Install]

- * Before opening the case, make sure to unplug the power cord.
- * 打開機殼前，請確實移除電源。
- * Before Connecting the power, make sure to fasten the case securely.
- * 接上電源前，請確實將機殼完整鎖附。

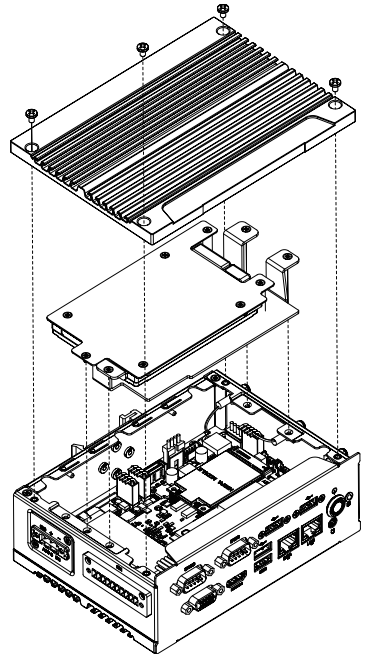
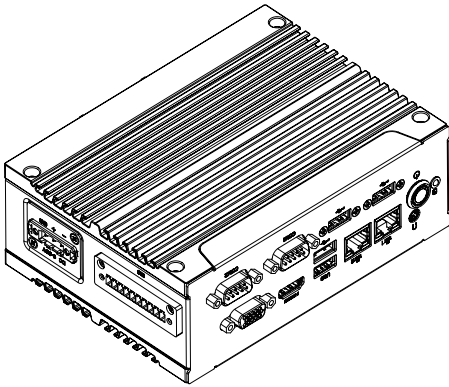

[Bottom PCB Side]

Information	
A	1 x NGFF 2280 M.2 slot (SATA 3Gb/s)
B	1 x Mini-PCIe slot (PCIe x1+USB2.0) with SIM Slot

Information	
C	1 x DDR3L SO-DIMM 1333 MHz sockets, Max. Capacity 8 GB
D	2.5" Hard drive/SSD

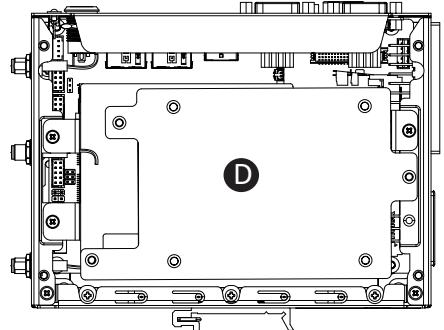
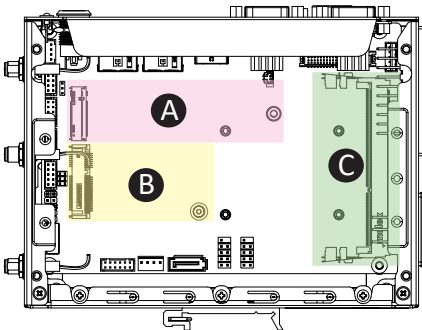

2.3 Memory Installation: DDR3L SO-DIMM

1

Carefully insert SO-DIMM memory modules.

小心地由下至上將 SO-DIMM 記憶體安裝於記憶體插槽。

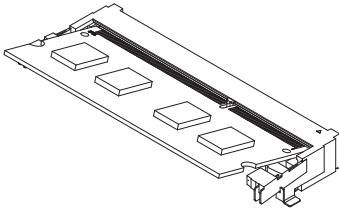
**2**

Push down until the modules click into place.

當記憶體固定於插槽後，再輕輕下壓至定點。

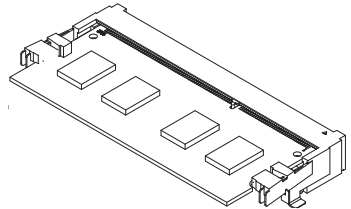

2.4 Antenna Installation (Antenna inclusion may vary based on local distribution)

1

Carefully insert the antennas into the connectors.

小心地將天線插入天線插孔中。

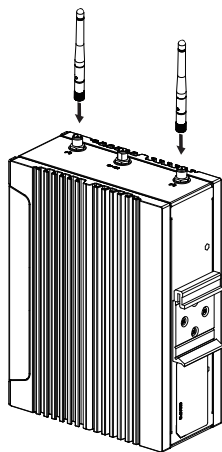

2

Turn the antennas clockwise until they are completely secure on the connectors.

握住天線接頭底端，按順時針方向將天線旋入插孔中牢牢固定。

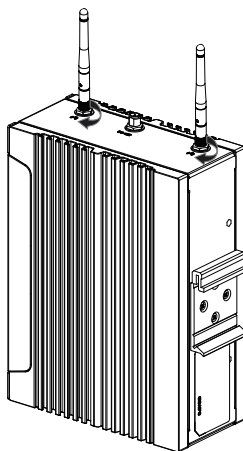

3

Flip up the antenna heads so that they are perpendicular to the machine.

栓緊後請將天線拉起朝上呈垂直狀。

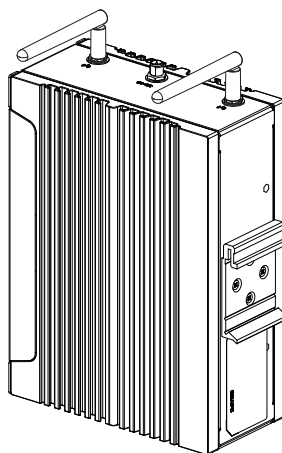
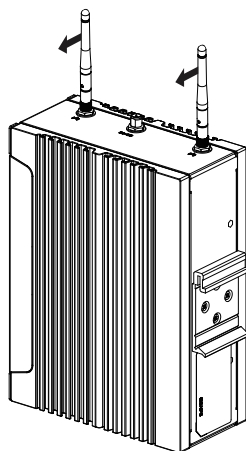

2.5 Din Rail Bracket Installation

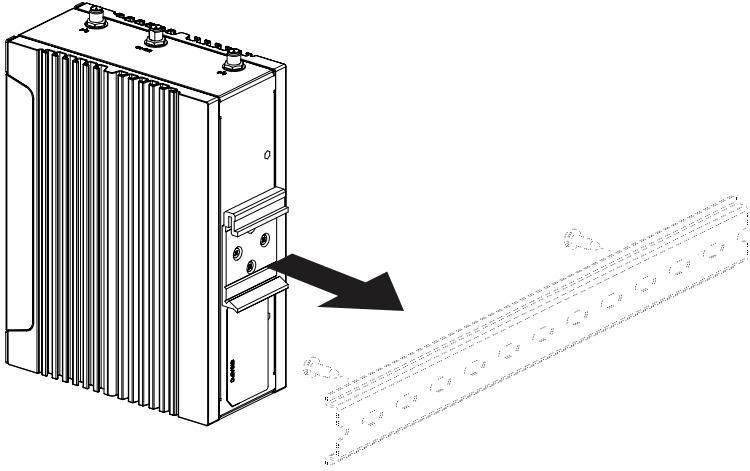
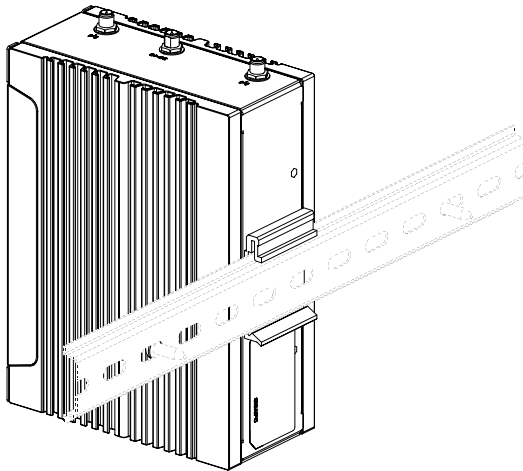
1**2**

2.6 HDD Installation

1

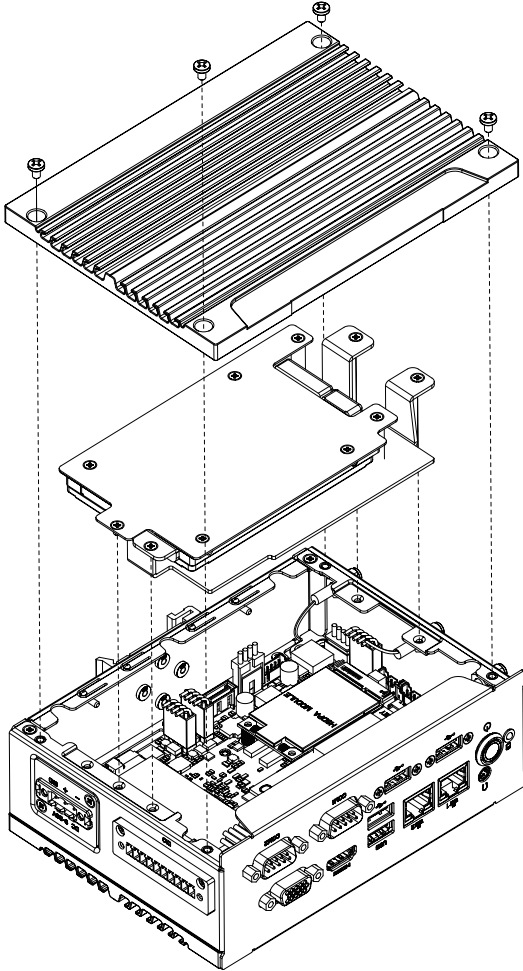

2

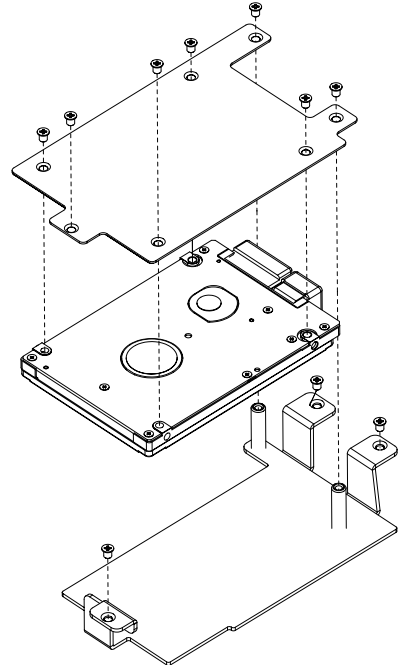

2.7 Cable Pin-define

1. DB9 COM (25CF8-180620-S9R)

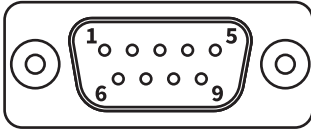

DB9 Pin	RS-232	RS-422 Full Duplex	RS-485 Half Duplex
1	DCD	TX-	D-
2	RXD	TX+	D+
3	TXD	RX+	-
4	DTR	RX-	-
5	GND		
6	DSR	-	-
7	RTS	-	-
8	CTS	-	-
9	RI	-	-

2. DBP DIO (25CR5-250607-S9R)

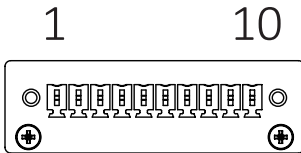

DBP DIO Pin	Pin Name
1	GPIO-output_1
2	GPIO-input_1
3	GPIO-output_2
4	GPIO-input_2
5	GPIO-output_3
6	GPIO-input_3
7	GPIO-output_4
8	GPIO-input_4
9	GND
10	5V

2.8 Support

- For a list of tested memory, M.2, 2.5'' SSD, wireless adapters and OS supported, go to: <http://www.gigaipc.com>
- To download the latest drivers and BIOS updates, go to: <http://www.gigaipc.com>
- For product support, go to: <http://www.gigaipc.com>

2.9 Safety and Regulatory Information

Risk of explosion if the battery is replaced with an incorrect type. Batteries should be recycled where possible.

Disposal of used Batteries must be in accordance with local environmental regulations.

Failure to use the included Power Adapter may violate regulatory compliance and may expose the user to safety hazards.

please use the power supply provided by (brand owner or agency) or use the power supply approved by (brand owner or agency) or buy power supply from (brand owner or agency). If you use an alternative power supply, it may be dangerous.

HDMI™
HIGH DEFINITION MULTIMEDIA INTERFACE



At the end of its serviceable life, this product should not be treated as household or general waste. It should be handed over to the applicable collection point for the recycling of electrical and electronic equipment, or returned to the supplier for disposal.

Chapter 3

Chapter 3 – Hardware Information

3.1 Jumpers and Connectors

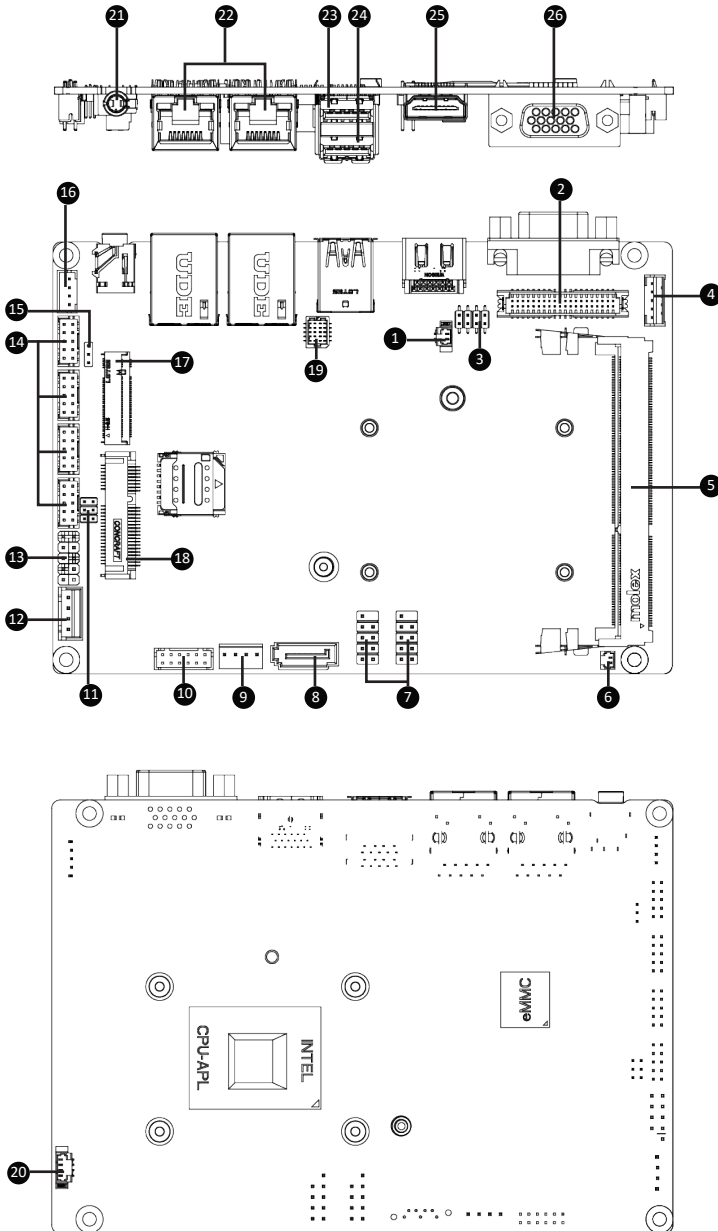

	Code	Description
1	Battery	Battery
2	LVDS	LVDS connector
3	LSW	LVDS resolution jumper
4	BKL_CN	Backlight brightness control connector
5	SODIMM	DDR3L SO-DIMM
6	BUZZER	
7	FUSB20_1 FUSB20_2	USB 2.0 header x 2
8	SATA	SATA 3GB/s Connector
9	SATAPW	SATA Power Connector
10	GPIO_CNT	General Purpose input/output header
11	JCOM11	RI# pin RI#/5V/12V Select jumper for COM1 port
12	DC_IN	DC IN 1x4pin power connector
13	SYS_PANEL	Front panel header
14	COM1 COM2 COM3 COM4	Serial port header COM1 : RS-232/422/485 & RI/5V/12V COM2 : RS-232/422/485 COM3, COM4 : RS-232
15	AT_CN	AT/ATX power mode select jumper
16	SPK_OUT	Speaker out connector
17	M2M	M.2 Slot, SATA, NGFF2280
18	MPCIE	Mini PCIe full size, support 3G/4G module
19	LPC_CN	LPC Connector

	Code	Description
20	FAN	FAN Connector
21	HP	Audio out Connector
22	LAN1, LAN2	LAN Connectors
23	RUSB1	USB 3.2 Gen 1 Connector
24	RUSB2	USB 2.0 Connector
25	HDMI	HDMI Connector
26	VGA	D-Sub Port

3.2.1 BATTERY

1

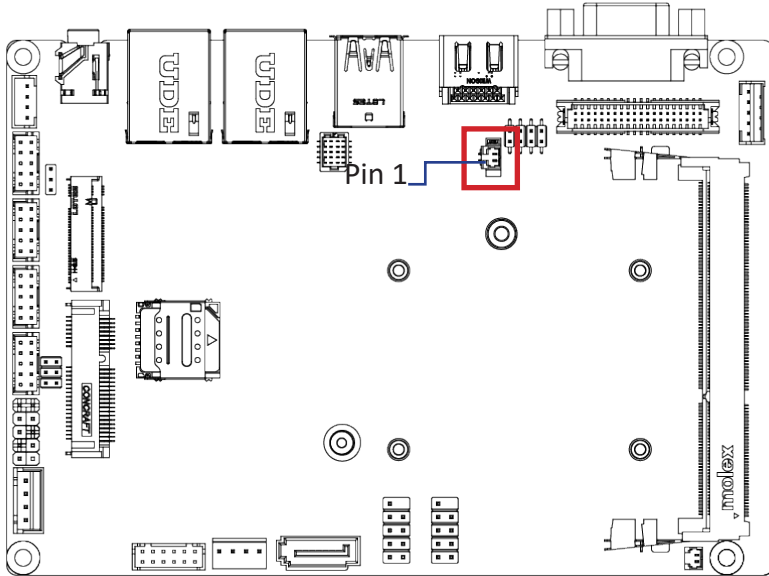

Battery Cable Connector



Connector PN	Vendor
85205-0270L	ACES
A1250WV-S-02PC	JOINT-TECH

Pin No.	Definition
1	3V
2	GND

3.2.2 LVDS (LVDS connector)

2

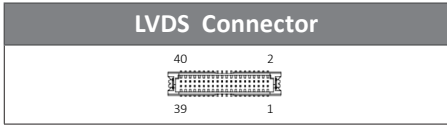
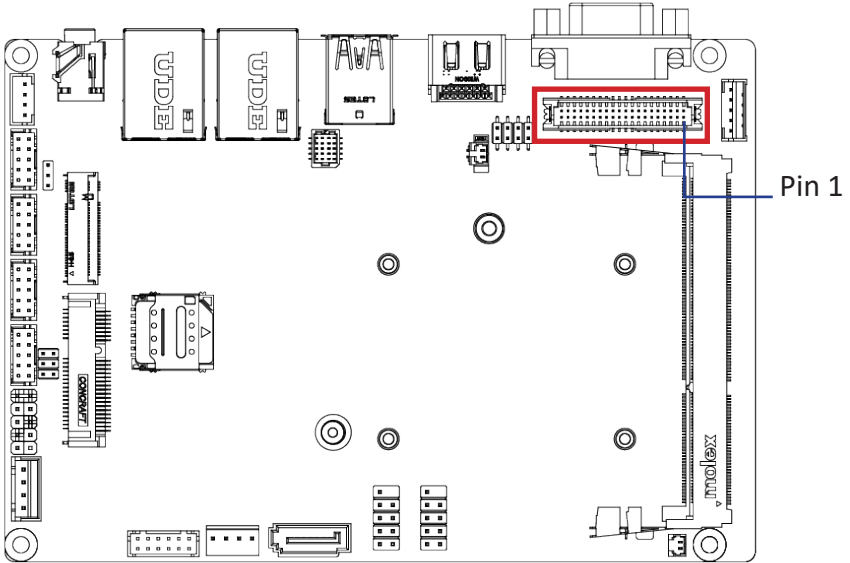

Pin No.	Definition	Pin No.	Definition
17	A3-	37	GND
18	A2-	38	GND
19	GND	39	12V
20	GND	40	12V

Pin No.	Definition	Pin No.	Definition
1	3.3V	21	A5+
2	5V	22	A4+
3	3.3V	23	A5-
4	5V	24	A4-
5	SPECO	25	GND
6	SPEDO	26	GND
7	GND	27	A7+
8	GND	28	A6+
9	A1+	29	A7-
10	A0+	30	A6-
11	A1-	31	GND
12	A0-	32	GND
13	GND	33	CLK2+
14	GND	34	CLK1+
15	A3+	35	CLK2-
16	A2+	36	CLK1-

Connector PN	Vendor
712-76-40GWE0	PINREX
A1252WV-SF-2X20PD01	JOINT-TECH

3.2.3 LSW (LVDS resolution jumper)

3

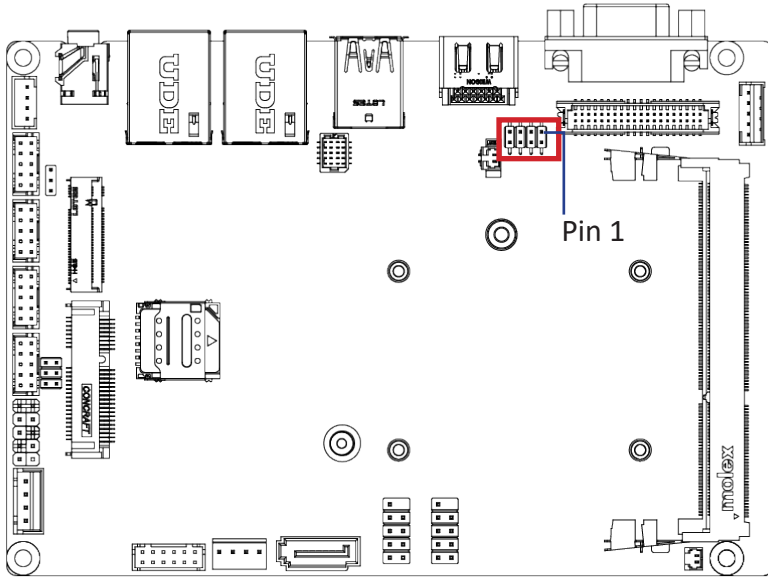

LVDS Resolution Jumper			
Jumper Setting	Resolution	Jumper Setting	Resolution
8 1111 1	800 x 600 18bit	8 1111 1	1366 x 768 24bit
8 1111 1	1024 x 768 18bit	8 1111 1	1440 x 900 24bit
8 1111 1	1024 x 768 24bit	8 1111 1	1400 x 1050 24bit
8 1111 1	1024 x 600 18bit	8 1111 1	1600 x 900 24bit
8 1111 1	1280 x 800 18bit	8 1111 1	1680 x 1050 24bit
8 1111 1	1280 x 960 18bit	8 1111 1	1600 x 1200 24bit
8 1111 1	1280 x 1024 24bit	8 1111 1	1920 x 1080 24bit
8 1111 1	1366 x 768 18bit	8 1111 1	1920 x 1200 24bit

Connector PN	Vendor
222-97-04GBE1	PINREX

3.2.4 BKL_CN (Backlight Control connector)

4

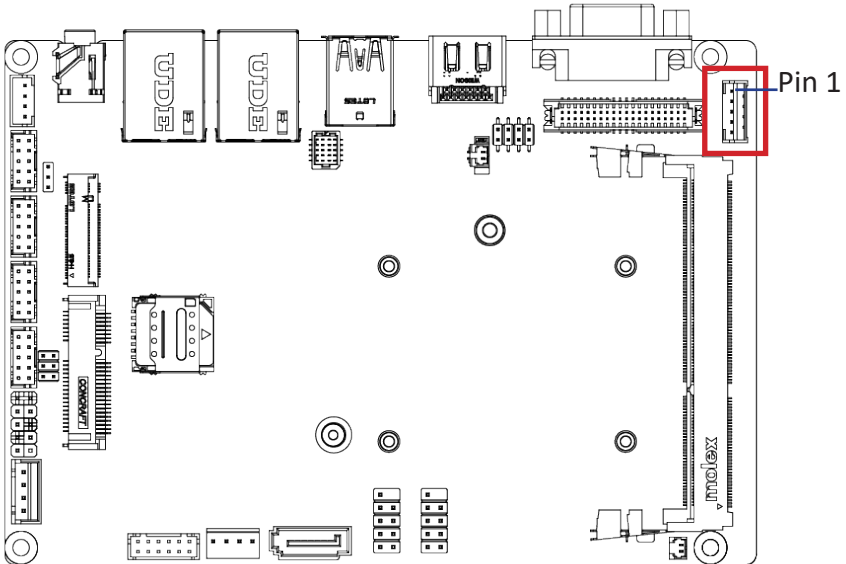

Backlight Control connector



Connector PN

721-81-05TW00

A2001WV-05P146

Vendor

PINREX

JOINT-TECH

Pin No.

Definition

1	5V
2	PWM
3	Backlight Enable
4	GND
5	12V

3.2.5 SODIMM (DDR3L SO-DIMM)

5

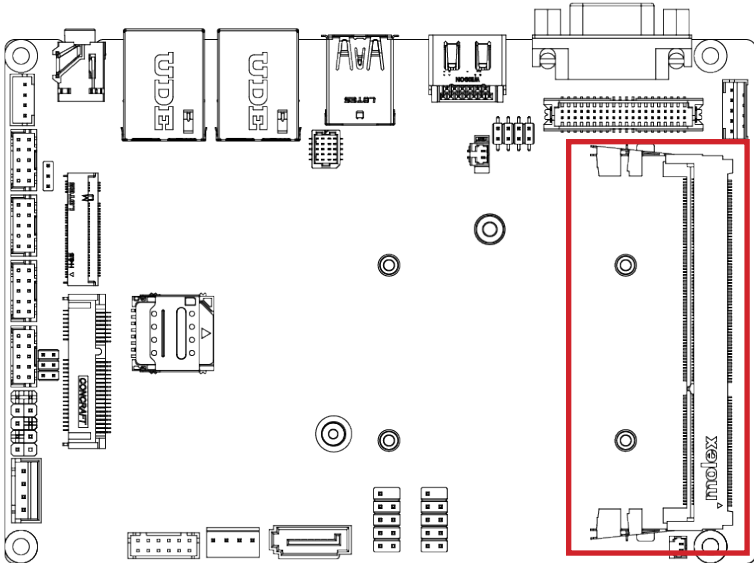

3.2.6 BUZZER

6

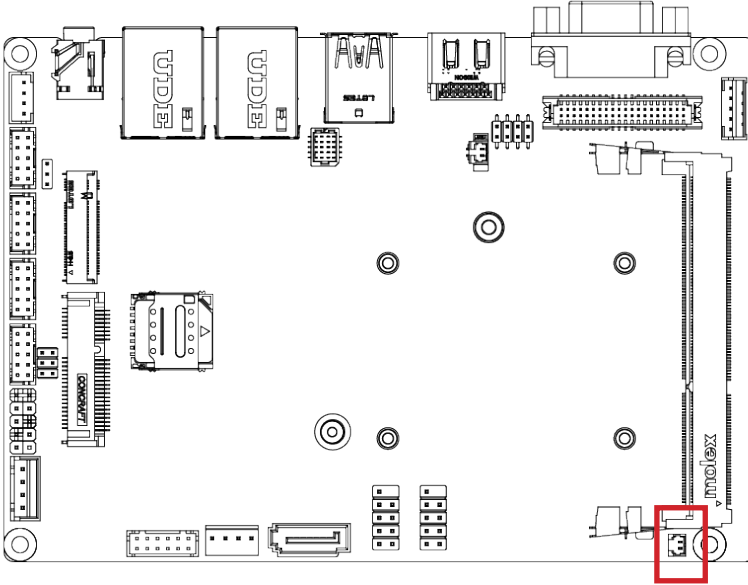

Buzzer

Connector PN	Vendor
712-71-02TW01	PINREX
A1250WV-02P	JOINT-TECH

Pin No.	Definition
1	SPK
2	5V

3.2.7 FUSB20_1, FUSB2_2 (USB 2.0 header)

7

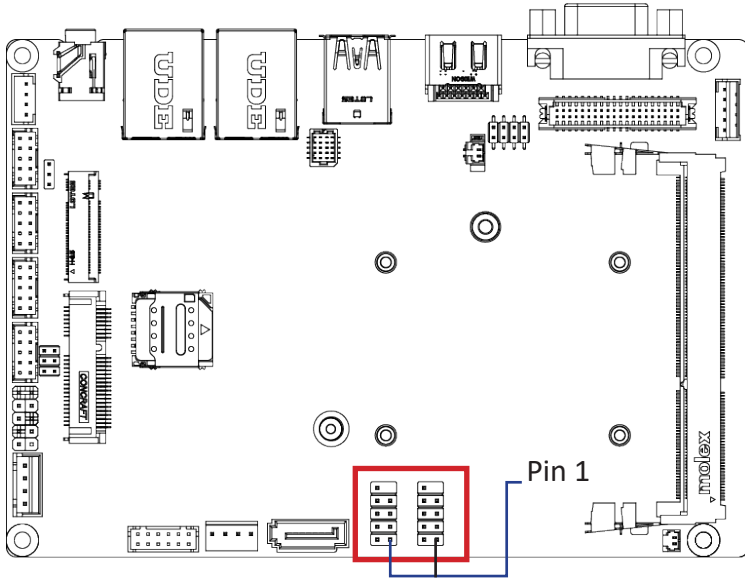

USB 2.0 Header



Connector PN

Vendor

210-92-05GB04

PINREX

PH10R53BAZ009

HORNGTONG

Pin No.	Definition
1	5V
2	5V
3	D2n
4	D1n
5	D2p
6	D1p
7	GND
8	GND
9	No Pin
10	No Connect

3.2.8 SATA (SATA 3 Gb/s Connector)

8

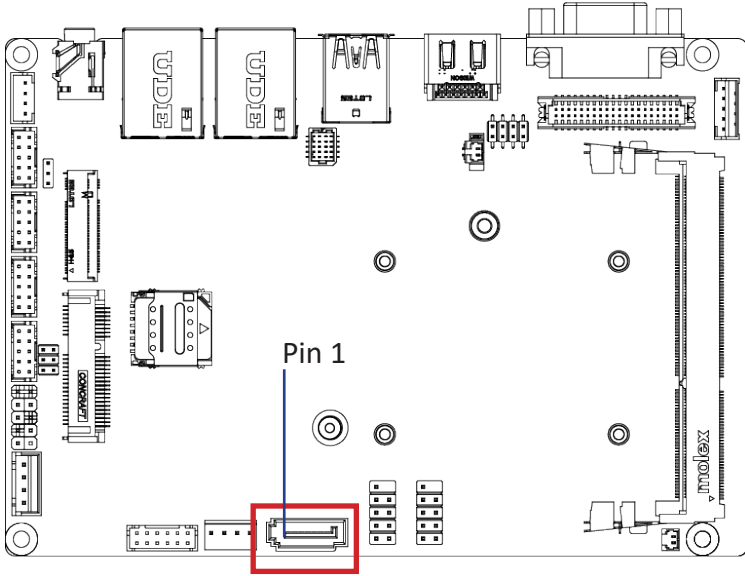

SATA 3 Gb/s Connector	

Connector PN	Vendor
WAT3M-07A1G3BU4W	WINWIN
ABA-SAT-054-S15	LOTES

Pin No.	Definition
1	GND
2	TXp
3	TXn
4	GND
5	RXn
6	RXp
7	GND

3.2.9 SATAPW (SATA power connector)

9

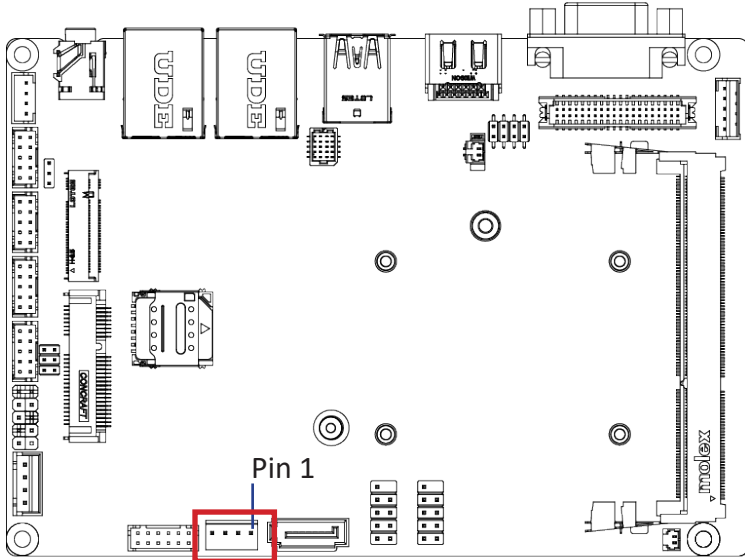

Hard Disk Power Connector



Connector PN

743-81-04TW00
WF04Q2-3BJQ000

Vendor

PINREX
HORNGTONG

Pin No. Definition

Pin No.	Definition
1	12V
2	GND
3	GND
4	5V

3.2.10 GPIO_CNT (General Purpose input/output header)

10

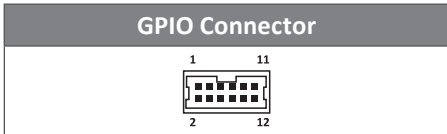
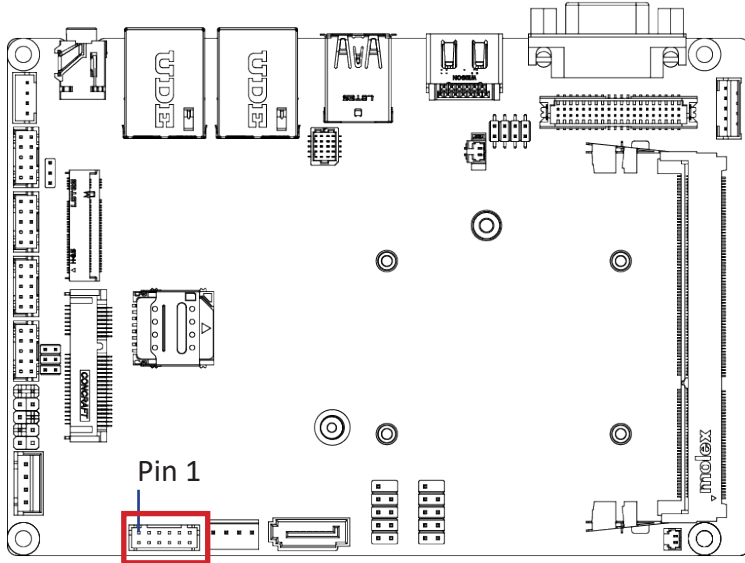

Connector PN	Vendor
725-81-12TW00	PINREX
A2004WV-2X06P46	JOINT-TECH

Pin No.	Definition
1	GPIO-output_1
2	GPIO-input_1
3	GPIO-output_2
4	GPIO-input_2
5	GPIO-output_3
6	GPIO-input_3
7	GPIO-output_4
8	GPIO-input_4
9	SMBus Clock
10	SMBus DATA
11	5V
12	GND

3.2.11 JCOM11 (RI# pin RI#/5V/12V Select jumper for COM1 port)

11

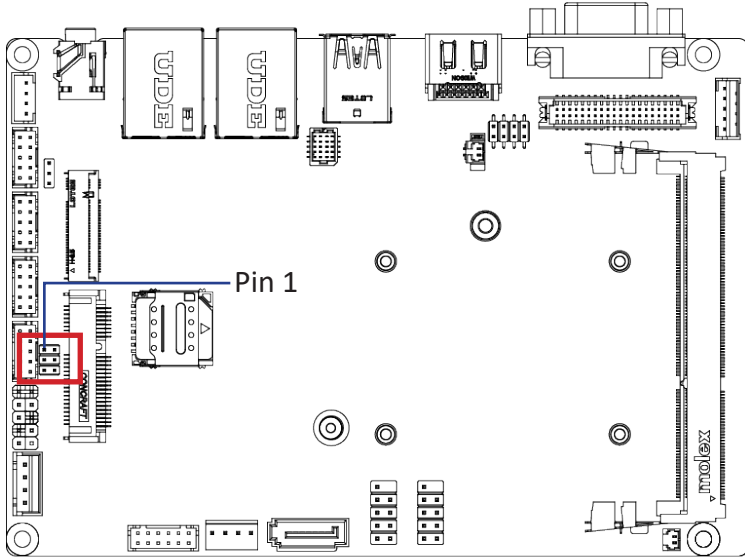

JCOM11 Jumper Select	
	1-2 Close: 5V (Power COM)
	3-4 Close: RI (Stand COM) Default
	5-6 Close: 12V (Power COM)

Connector PN	Vendor
220-97-03GB01	PINREX
PH06N53BAZ000	HORNGTONG

3.2.12 DC IN (DC IN 1x4pin power connector)

12

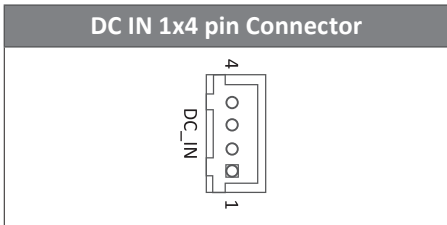
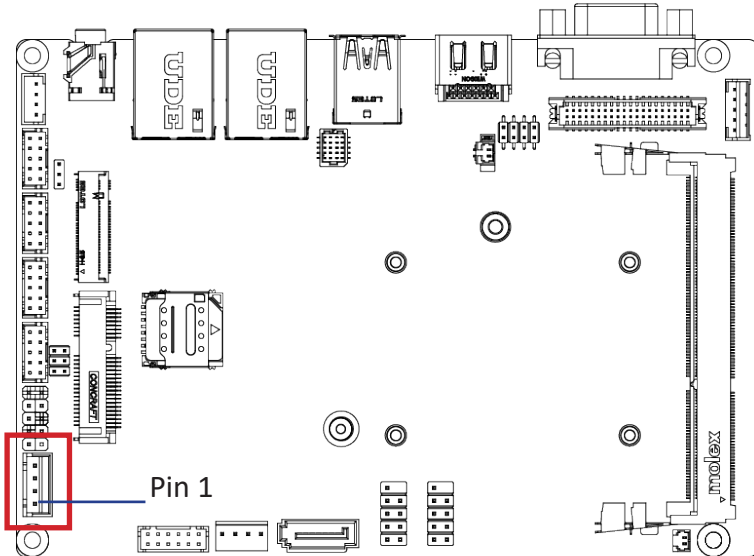

Connector PN	Vendor
753-81-04TW00	PINREX

Pin No.	Definition
1	GND
2	DC IN
3	DC IN
4	GND

3.2.13 SYS_PANEL (Front panel header)

13

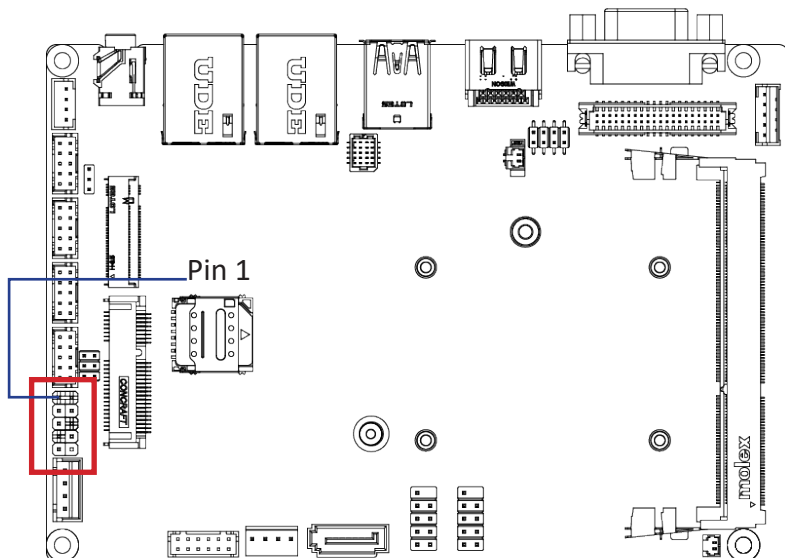

System Panel Header



Connector PN

210-92-05G111

Vendor

PINREX

Pin No.	Definition
1	HD-p
2	MPD-p
3	HD-n
4	MPD-n
5	GND
6	POWER-ON
7	Reset
8	GND
9	Reserved
10	NC

3.2.14 COM1, COM2, COM3, COM4 (Serial port header)

14

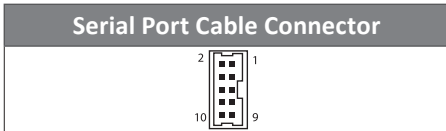
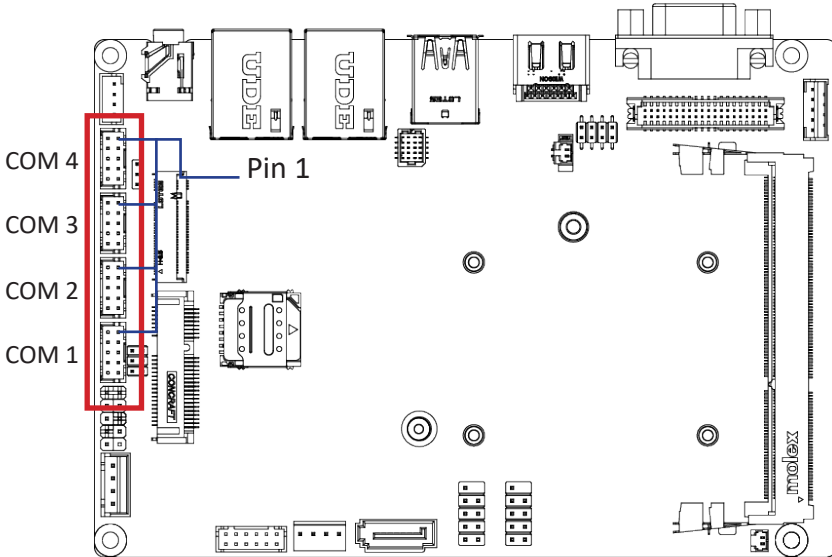

Pin No.	RS-232	RS-422 Full Duplex	RS-485 Half Duplex
1	RXD	TXD+	D+
2	DCD	TXD-	D-
3	DTR	RXD-	-
4	TXD	RXD+	-
5	DSR	-	-
6	GND	-	-
7	CTS	-	-
8	RTS	-	-
9	No Connect	-	-
10	RI/5V/12V	-	-

Connector PN	Vendor
725-81-10TW00	PINREX
A2004WV-2X05P46	JOINT-TECH

Note :

COM1 : Support RS-232/422/485 & RI/5V/12V
 For RI/5V/12V jumper setting, please see P. 41

COM2 : Support RS-232/422/485

COM3, COM4 : Support RS-232 only

3.2.15 AT_CN (AT/ATX power mode select jumper)

15

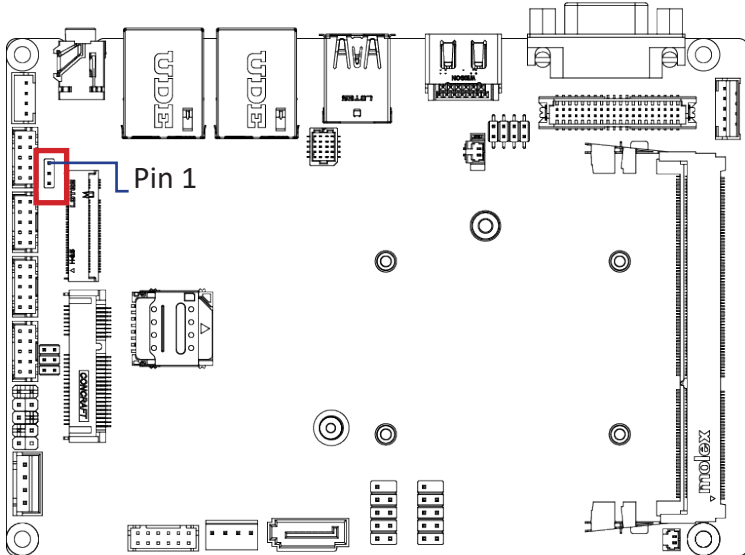

AT/ATX power mode select jumper



1-2 Close : AT mode.

2-3 Close : ATX mode.
(Default setting)

Connector PN

220-96-03GB01

PH03N2-7BAN000

Vendor

PINREX

HORNGTONG

Pin No.

Definition

1

AT MODE

2

Detect

3

ATX MODE

3.2.16 SPK_OUT (Speaker out connector)

16

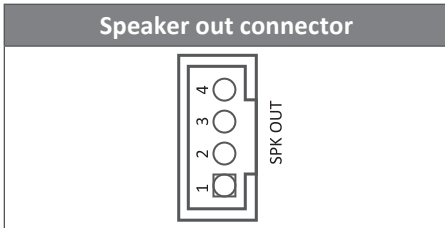
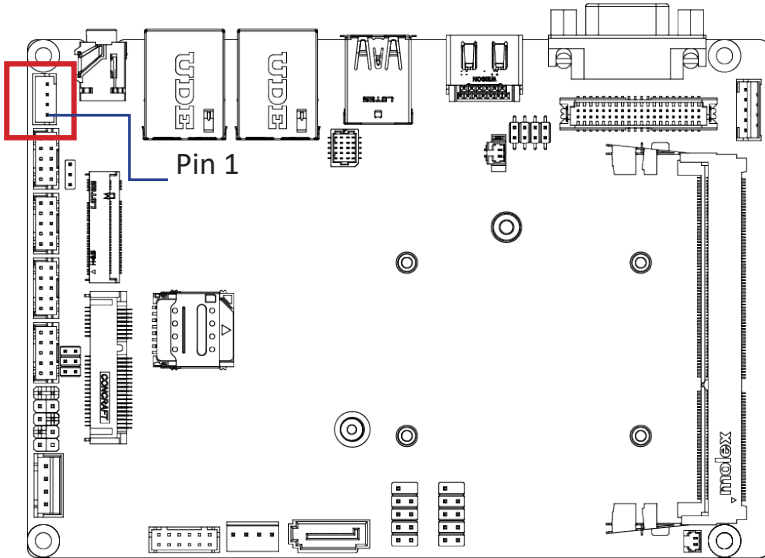

Connector PN	Vendor
721-81-045W00	PINREX
A2001WV-04P146	JOINT-TECH

Pin No.	Definition
1	Speaker Out R+
2	Speaker Out R-
3	Speaker Out L-
4	Speaker Out L+

3.2.17 M2M (M.2 Slot, SATA, NGFF2280)

17

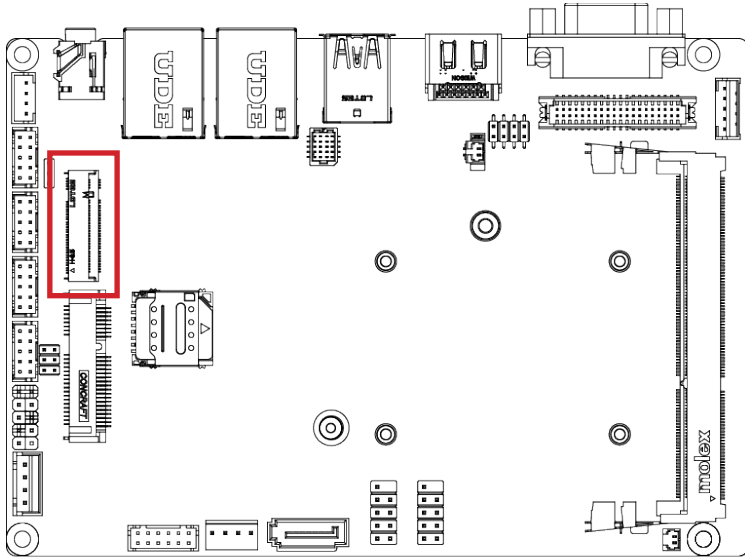

M.2 M Key Connector



Pin No.	Definition	Pin No.	Definition
1	GND	2	3.3V
3	GND	4	3.3V
5	NC	6	NC
7	NC	8	NC
9	GND	10	NC
11	NC	12	3.3V
13	NC	14	3.3V
15	GND	16	3.3V
17	NC	18	3.3V
19	NC	20	NC
21	GND	22	NC
23	NC	24	NC
25	NC	26	NC
27	GND	28	NC
29	NC	30	NC
31	NC	32	NC
33	GND	34	NC
35	NC	36	NC
37	NC	38	NC

Pin No.	Definition	Pin No.	Definition
39	GND	40	NC
41	SATA RXp	42	NC
43	SATA RXn	44	NC
45	GND	46	NC
47	SATA TXn	48	NC
49	SATA TXp	50	Reset
51	GND	52	NC
53	NC	54	NC
55	NC	56	NC
57	GND	58	NC

Pin No.	Definition	Pin No.	Definition
67	NC	68	NC
69	NC	70	3.3V
71	GND	72	3.3V
73	GND	74	3.3V
75	GND		

Connector PN	Vendor
80159-8521	BELLWETHER
2E0BC21-S85BM-7H	FOXCONN
APCI0096-P002A	LOTES

3.2.18 MPCIE (Mini PCIe slot)

18

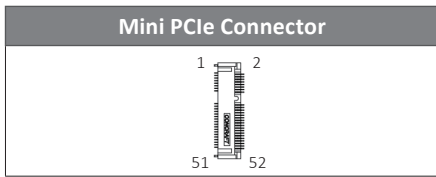
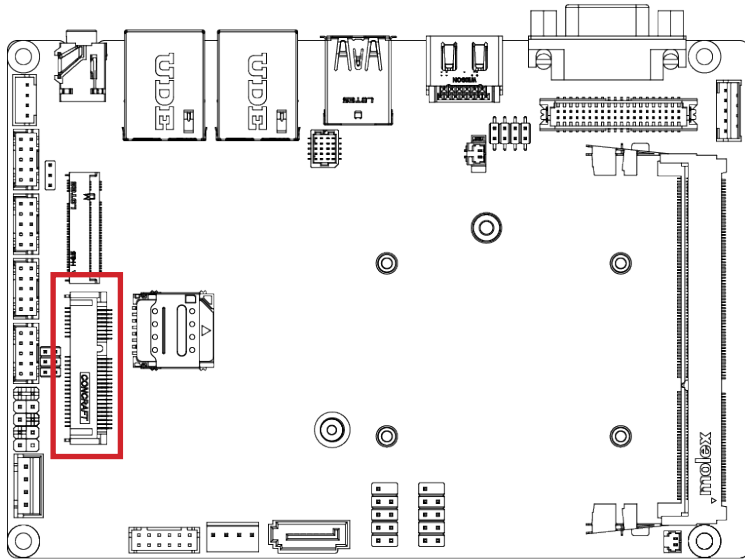

Pin No.	Definition	Pin No.	Definition
1	PCIE WAKE	2	3.3V
3	NC	4	GND
5	NC	6	NC
7	PCIE Clock Request	8	SIM VDD
9	GND	10	SIM DATA
11	PCIE Clock-	12	SIM Clock
13	PCIE Clock+	14	SIM Reset
15	GND	16	UIM VPP3
17	NC	18	GND
19	NC	20	MPWF_DISABLE
21	GND	22	PFRreset
23	PCIE RX-	24	3.3V
25	PCIE RX+	26	GND
27	GND	28	NC
29	GND	30	SMB Clock
31	PCIE TX-	32	SMB DATA

Pin No.	Definition	Pin No.	Definition
33	PCIE TX+	34	GND
35	GND	36	USB D-
37	GND	38	USB D+
39	3.3V	40	GND
41	3.3V	42	NC
43	GND	44	NC
45	NC	46	NC
47	NC	48	NC
49	NC	50	GND
51	NC	52	3.3V

Connector PN	Vendor
AS0B221-S99Q-7H	FOXCONN

3.2.19 LPC_CN (LPC Connector)

19

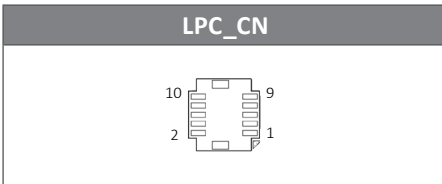
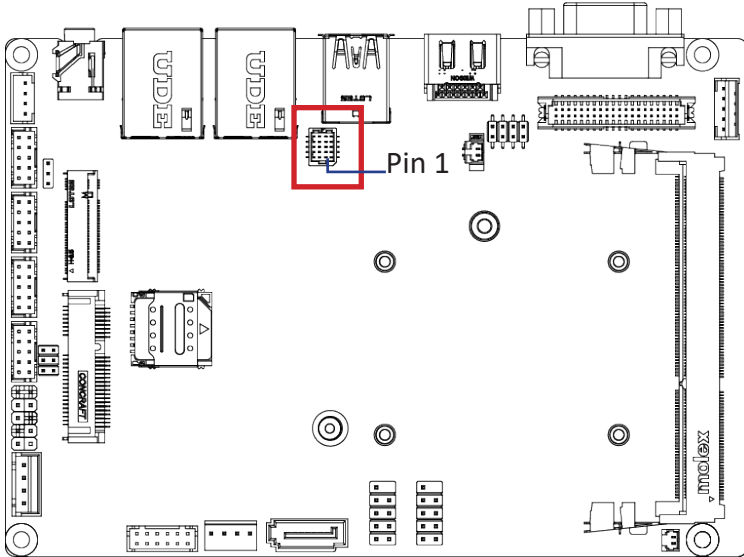

Pin No.	Definition
1	LPC_CLK
2	GND
3	LFRAME#
4	LAD0
5	PCI_RST
6	LAD1
7	LAD3
8	LAD2
9	3.3V
10	SERIRQ

3.2.20 FAN (FAN Connector)

20

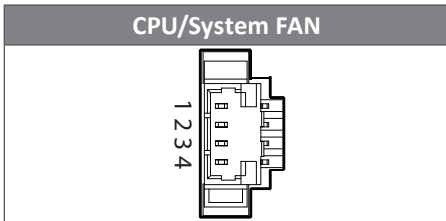
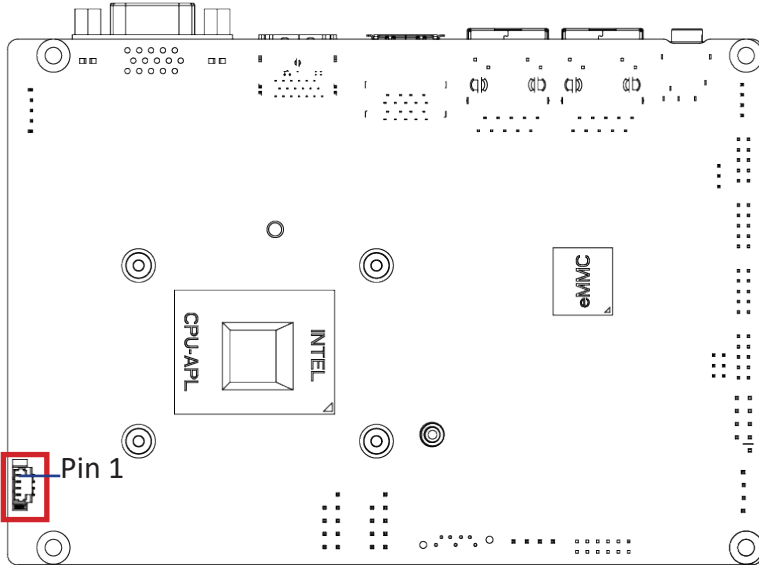

Connector PN	Vendor
85205-0470N	ACES
A1250WV-S-04PC	JOINT-TECH

Pin No.	Definition
1	GND
2	12V
3	Detect
4	Speed Control

3.2.21 LAN1, LAN2 (LAN Connector)

22

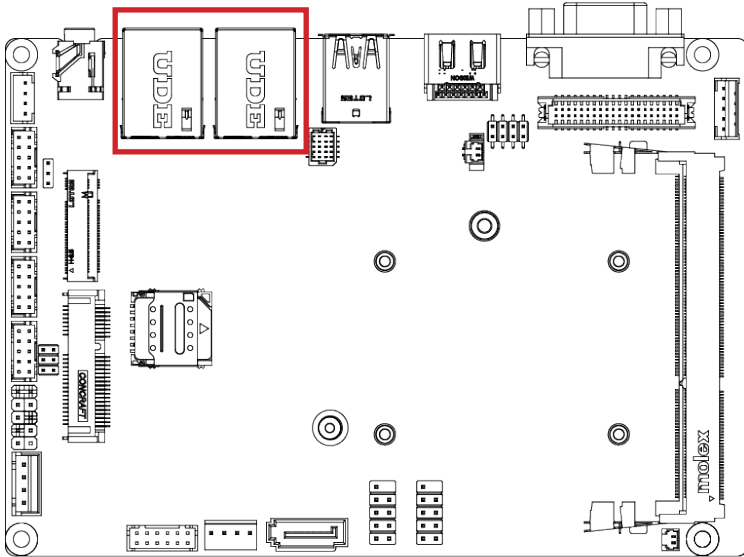

LAN Connector



Status	Description
Orange On	1Gbps data rate
Green On	100Mbps data rate
Off	10Mbps data rate

Pin No.	Definition
1	TX1+
2	TX1-
3	TX2+
6	TX2-
4	TX3+
5	TX3-
7	TX4+
8	TX4-

3.2.22 RUSB1, RUSB2 (USB 3.2 Gen 1 + USB 2.0 connector)

23 24

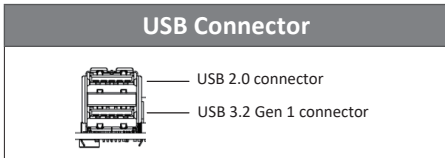
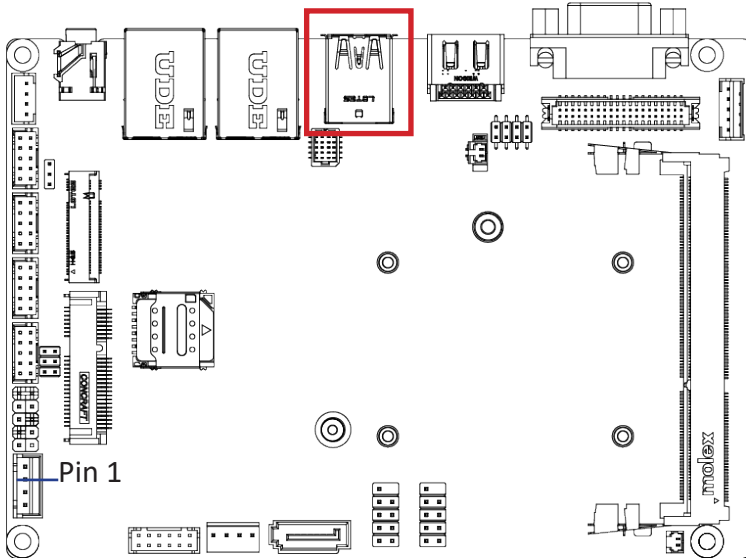

Pin No.	Definition	Pin No.	Definition
1	5V	10	5V
2	D1n	11	D0n
3	D1p	12	D0p
4	GND	13	GND
5	USB3_RX1n	14	USB3_RX2n
6	USB3_RX1p	15	USB3_RX2p
7	GND	16	GND
8	USB3_TX1n	17	USB3_TX2n
9	USB3_TX1p	18	USB3_TX2p

3.2.23 HDMI (HDMI Connector)

25

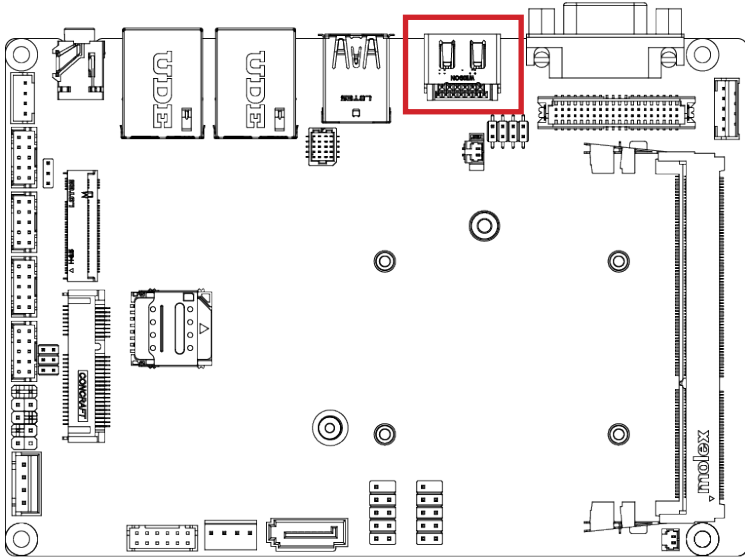

Pin No.	Definition	Pin No.	Definition
1	TX2p	11	GND
2	GND	12	CLKn
3	TX2n	13	NC
4	TX1p	14	NC
5	GND	15	SCL
6	TX1n	16	SDA
7	TX0p	17	GND
8	GND	18	5V
9	TX0n	19	Hot Plug Detect
10	CLKp		

3.2.24 VGA (D-sub port)

26

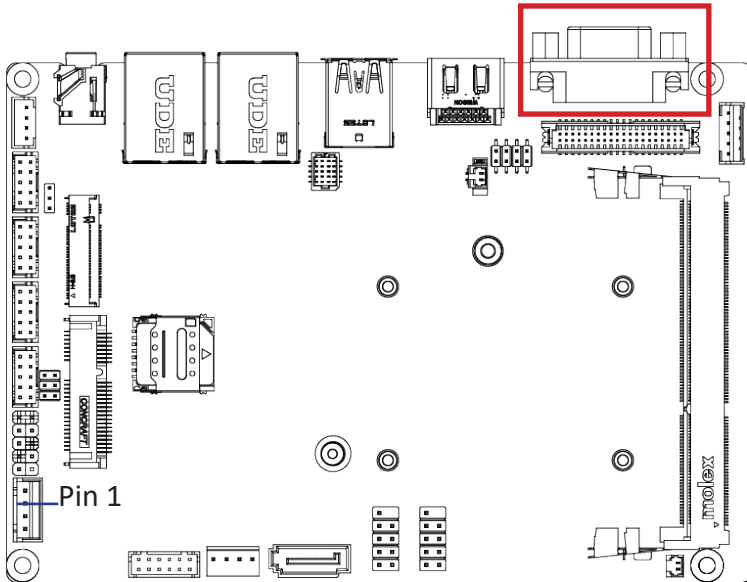

Pin 1

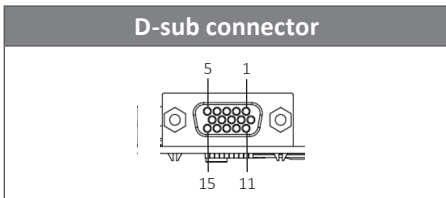

Pin No.	Definition
1	Red
2	Green
3	Blue
4	GND
5	GND
6	GND
7	GND
8	GND
9	5V
10	GND
11	NC
12	DDCSDA
13	HSYNC
14	VSYNC
15	DDCSCL

Chapter 4

Chapter 4 – BIOS

4.1 Introduction

BIOS (Basic input/output system) provides hardware detailed information and boot-up options, which include firmware to control, set-up and test all hardware settings. Therefore, BIOS is the communication bridge between OS/application software and hardware.

4.1.1 How to Entering into BIOS menu

Once the system is power on, press the key as soon as possible to access into BIOS Setup program.

4.1.2 Function Keys to setup in BIOS Setup program

Function keys	Description
→←	Select Screen
↑↓	Select Item
Enter	Execute command or enter the submenu
+	Increase the numeric value or make changes
—	Decrease the numeric value or make changes
F1	General Help
F2	Previous Values
F3	Load Optimized Defaults Settings
F4	Save changes & Exit the BIOS Setup program
ESC	Exit the BIOS Setup program

4.2 The Main Menu

The main menu shows the basic system information. Use arrow keys to move among the items.

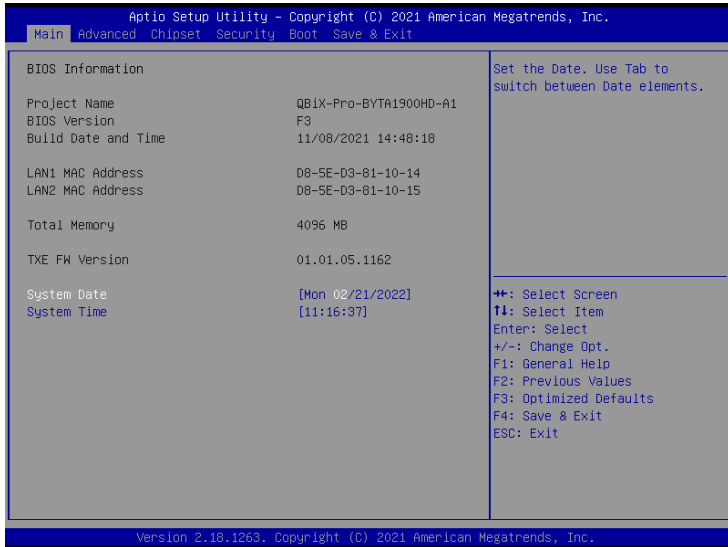

Items	Description
Project Name	Shows Project name information
BIOS Version	Shows the BIOS version of the system
Build Date and Time	Shows the Build Date and Time when the BIOS was created.
LAN1 MAC Address	Shows LAN MAC Address information
LAN2 MAC Address	Shows LAN MAC Address information
Total Memory	Shows the total memory size of the installed memory
TXE FW version	Shows TXE firmware version
System Date	Set the Date for the system (Format : Weekday - Month - Day - Year)
System Time	Set the time for the system (Format : Hour - Minute - Second)

4.3 Advanced

The Advanced menu is to configure the functions of hardware settings through submenu. Use arrow keys to move among the items, and press <Enter> to access into the related submenu.

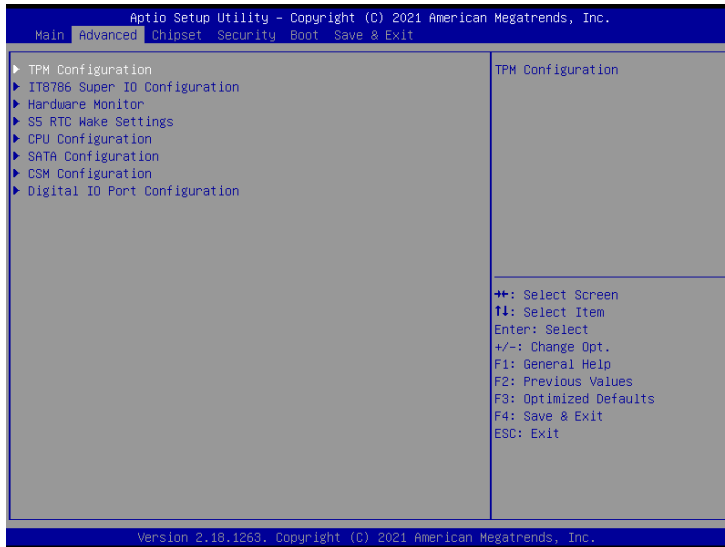

4.3.1 TPM Configuration

Use TPM Configuration submenu to choose TPM interface.



Item	Description
fTPM	Enabled : Enables firmware TPM (Default setting) Disabled : Disables firmware TPM

Trusted Computing : Shows TPM information, and TPM module configuration setting.



Item	Description
Security Device support	Enabled : Enables TPM feature (Default setting) Disabled : Disables TPM feature
Item	Description
Pending operation	None : No execution will be conducted (Default setting) TPM clear : Set to clear data on TPM

4.3.2 IT8786 Super I/O Configuration

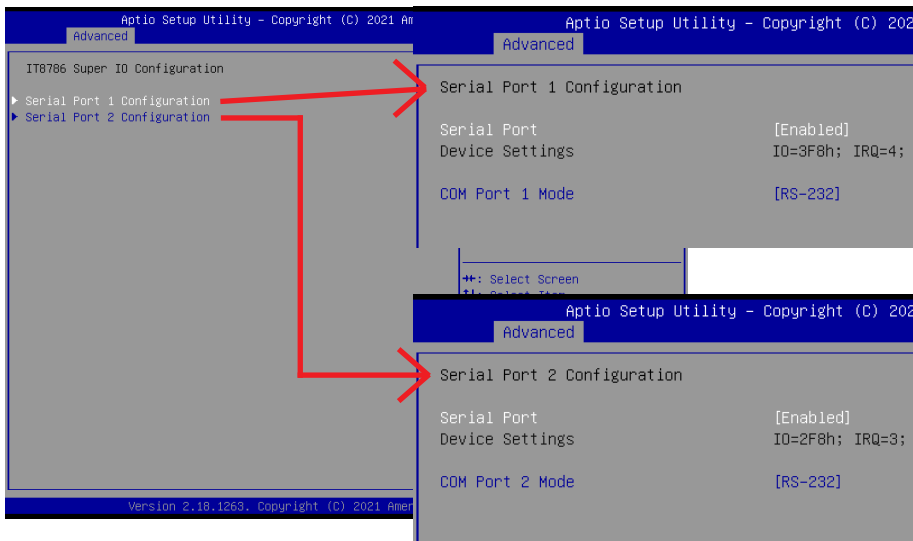

Item	Description
<p>Serial Port 1 Configuration</p>	<p>Press [Enter] to configure advanced items :</p> <p>Serial Port : Enabled : Enables allows you to configure the serial port settings Disabled : if Disabled, displays no configuration for the serial port</p> <p>Device settings : Display the specified Serial Port base I/O address and IRQ</p> <p>COM Port 1 Mode : Choose RS-232, RS-422, or RS-485 feature</p>
<p>Serial Port 2 Configuration</p>	<p>Press [Enter] to configure advanced items :</p> <p>Serial Port : Enabled : Enables allows you to configure the serial port settings Disabled : if Disabled, displays no configuration for the serial port</p> <p>Device settings : Display the specified Serial Port base I/O address and IRQ</p> <p>COM Port 2 Mode : Choose RS-232, RS-422, or RS-485 feature</p>

4.3.3 Hardware Monitor

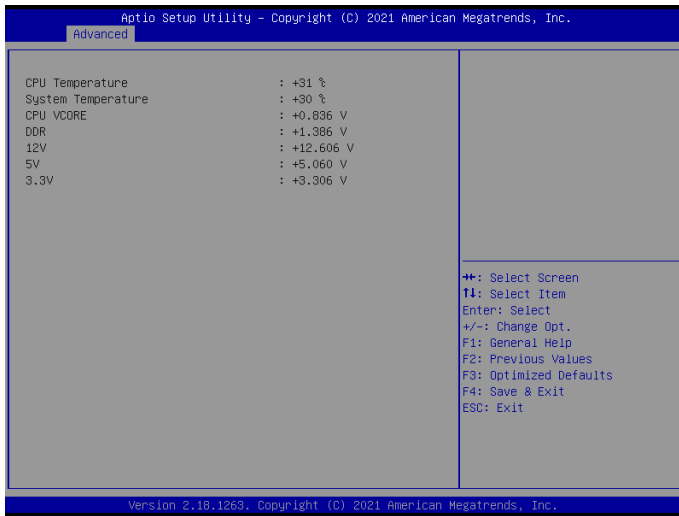

Item	Description
CPU temperature	Shows current CPU temperature
System temperature	Shows current system temperature
CPU VCORE	Shows current CPU Voltage
DDR	Shows current DDR Voltage

4.3.4 S5 RTC Wake Settings

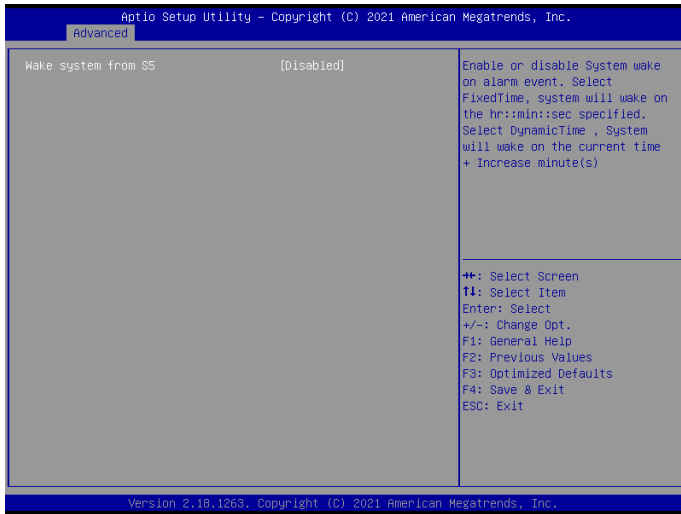

Item	Description
Wake system from S5	Enable or Disable System to wake on a specific time. Disabled : Disables system to wake on a specific time (Default setting) Fixed Time : Enables system to wake on a specific time (Format : hr : min : sec)

4.3.5 CPU Configuration

This submenu shows detailed CPU informations.

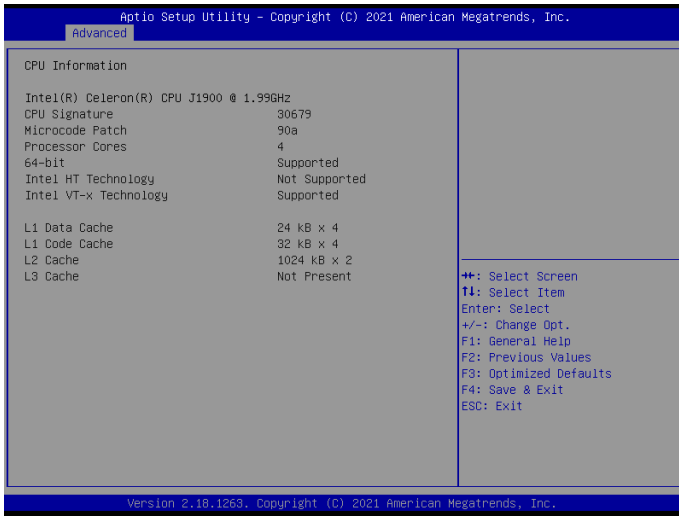

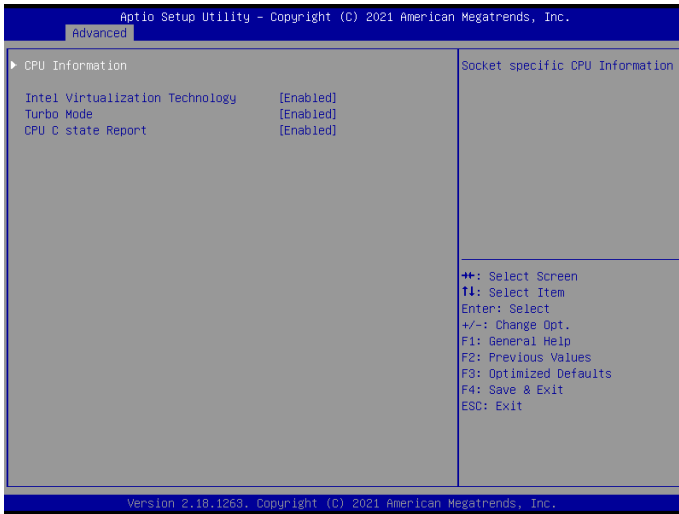

Item	Description
Intel Virtualization Technology	Virtualization enhanced by Intel® Virtualization Technology will allow a platform to run multiple operating systems and applications in independent partitions. With virtualization, one computer system can function as multiple virtual systems. Enabled : Enables Intel Virtualization Technology (Default setting) Disabled : Disables Intel Virtualization Technology
Turbo Mode	Enabled : Enables Turbo Mode (Default setting) Disabled : Disables Turbo Mode
CPU C state Report	Command CPU to enter into low power consumption mode when CPU is under idle mode. Enabled : Enables C states (Default setting) Disabled : Disables C states

4.3.6 SATA Configuration

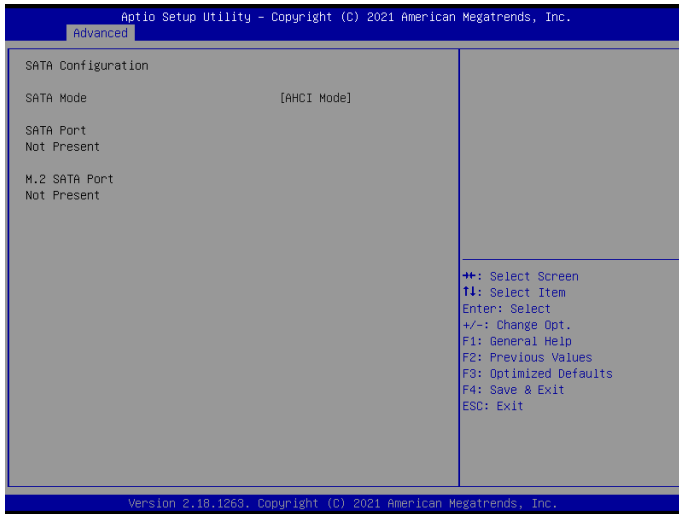

Item	Description
SATA Mode	AHCI Mode : Configures the SATA controllers to AHCI mode
Serial Port	shows 2.5" SATA HDD/SSD information
M.2 SATA Port	shows M.2 SATA interface SSD information

4.3.7 CSM Configuration

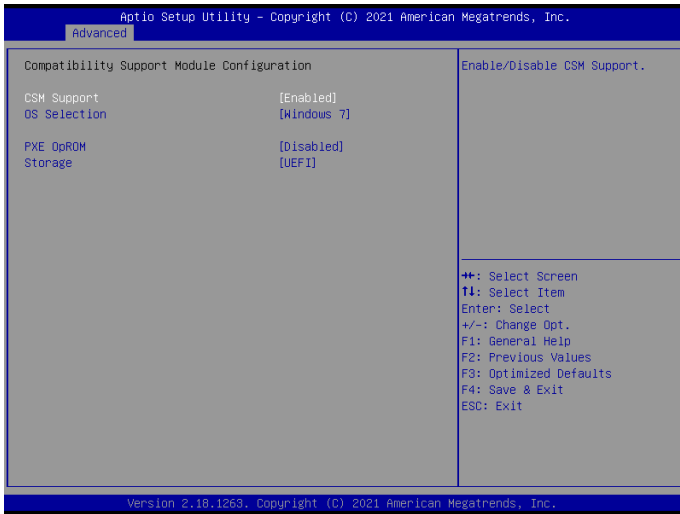

Item	Description
CSM Support	Choose UEFI or Legacy Mode Disabled : UEFI Mode only Enabled : Enables Legacy Mode feature (Default setting)
OS Selection	Choose OS version : Windows 10 or Windows 7 (Default setting)
PXE OpROM	Allows to select whether to enable Legacy PXE option ROM Disabled : Disables PXE OpROM (Default setting) Enabled : Enables PXE OpROM
Storage	Allows to select whether to enable UEFI or Legacy Storage option ROM Do not launch : Disables option ROM UEFI : Enables UEFI option ROM only. (Default setting) Legacy : Enables Legacy option ROM only

4.3.8 Digital IO Port Configuration

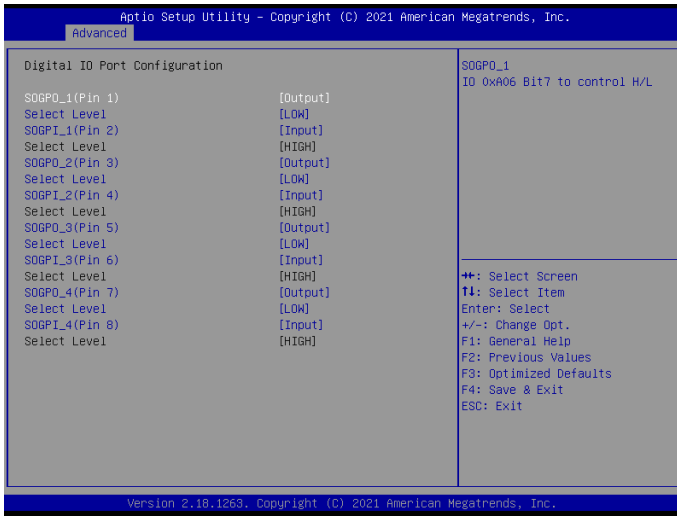

Item	Description
SOGPO_1 (Pin 1) SOGPI_1 (Pin 2) SOGPO_2 (Pin 3) SOGPI_2 (Pin 4) SOGPO_3 (Pin 5) SOGPI_3 (Pin 6) SOGPO_4 (Pin 7) SOGPI_4 (Pin 8)	Configure Digital IO Input or Output values for each pin.

4.4 Chipset

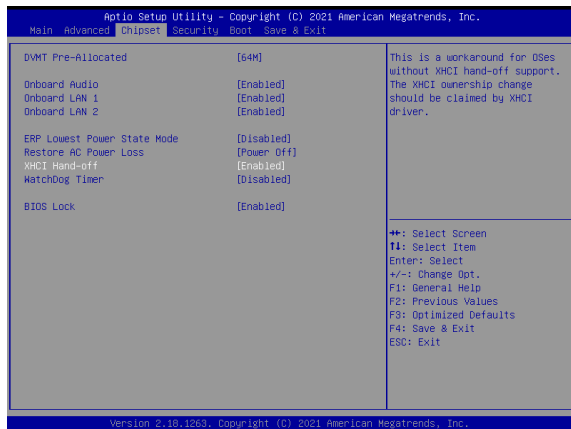

Item	Description
DVMT Pre-Allocated	Use DVMT Pre-Allocated to set the amount of system memory which is installed to the integrated graphics processor Option items : 64M(Default setting), 128M, 256M, 512M
Onboard Audio	Enable/Disable onboard audio controller Enabled : Enables onboard audio controller (Default setting) Disabled : Disables onboard audio controller
Onboard LAN1 Onboard LAN2	Enable/Disable onboard LAN controller Enabled : Enables onboard LAN controller (Default setting) Disabled : Disables onboard LAN controller
ERP Lowest Power State Mode	Enable/Disable power saving function Enabled : Enables ERP Lowest Power State Mode Disabled : Disabled ERP Lowest Power State Mode (Default setting)
Restore AC Power Loss	To set which option the system should returns if a sudden power loss occurred Power off : Do not power on when the power is back (Default setting) Power on : System power on when the power is back Last state : Restore the system to the state before power loss occurs
XHCI Hand-off	Enable/Disable XHCI Hand-off function Enabled : Enables XHCI Hand-off function (Default setting) Disabled : Disables XHCI Hand-off function
Watchdog Timer	Enable/Disable Watchdog Timer function Enabled : Enables Watchdog Timer function Disabled : Disabled Watchdog Timer function (Default setting)
BIOS Lock	Enable/Disable BIOS Lock function Enabled : Enables BIOS Lock function (Default setting) Disabled : Disabled BIOS Lock function

4.5 Security

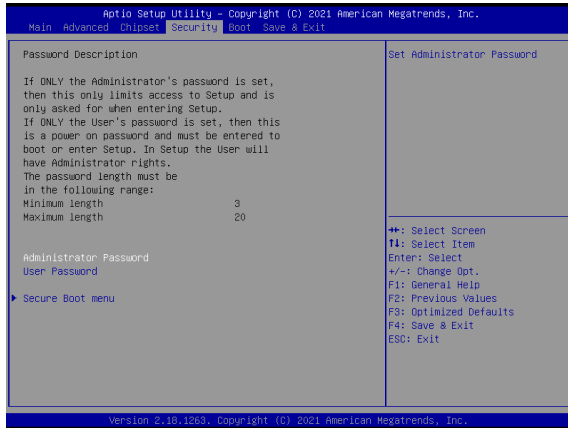

Item	Description
Administrator Password	To set up Administrator's password Minimum length : 3 Maximum length : 20
User Password	To set up User's password Minimum length : 3 Maximum length : 20
Secure Boot	Press <Enter> to configure the advanced items

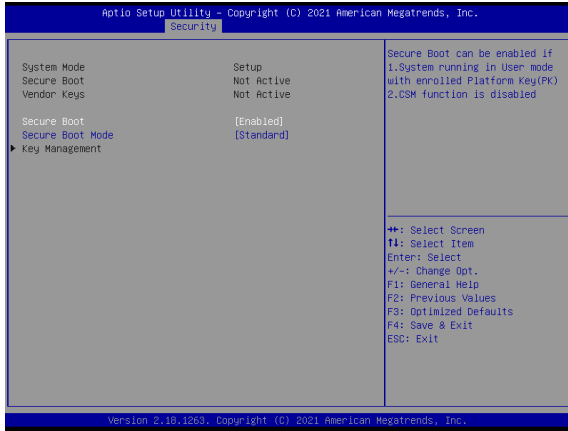

Item	Description
Secure Boot	Secure Boot requires all the applications that are running during the booting process to be pre-signed with valid digital certificates Enabled : Enables Secure Boot function Disabled : Disables Secure Boot function (Default setting)
Secure Boot Mode	Standard : Standard mode Custom : Custom mode (Default setting)
Key Management	Enables expert users to modify Secure boot policy variables without full authentication Press <Enter> to configure the advanced items

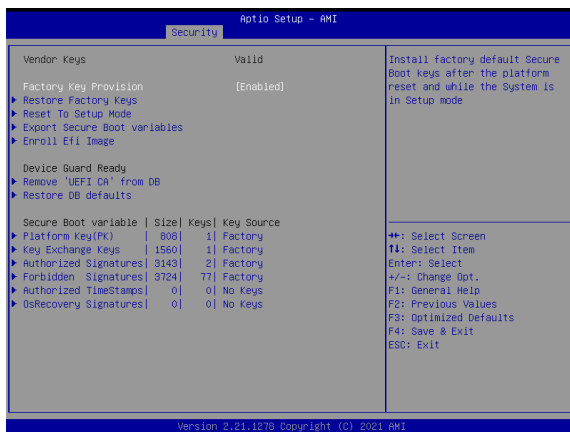

Item	Description
Factory Key Provision	Install factory default Secure Boot keys after the platform reset and while the system is in Setup mode Enabled : Enables Factory Key Provision (Default setting) Disabled : Disables Factory Key Provision
Restore Factory Keys	To restore factory settings Yes : Agree to restore factory settings No : Cancel to restore factory settings
Reset To Setup Mode	Yes : Agree to setup mode No : Cancel to setup mode
Export Secure Boot variables	Copy NVRAM content of Secure Boot variables to files in a root folder on a file system device
Enroll Efi Image	Allow the image to run in Secure Boot mode
Remove 'UEFI CA' from DB	To remove 'UEFI CA' from database Yes : Agree to remove 'UEFI CA' from database No : Cancel to remove 'UEFI CA' from database
Restore DB defaults	Restore DB variables to factory defaults Yes : Agree to restore DB defaults No : Cancel to restore DB defaults

Item	Description
Platform Key (PK)	These items allows you to enroll factory defaults or load Certificates from a file.
Key Exchange Keys	
Authorized Signatures	
Forbidden Signatures	
Authorized TimeStamps	
OsRecovery Signatures	

4.6 Boot

This Boot menu allows you to set/change system boot options



Item	Description
Screen LOGO Show	Enable/Disable full screen LOGO show on POST screen Enabled : Enables Full screen LOGO Show on POST screen (Default setting) Disabled : Disables Full screen LOGO Show on POST screen
Boot Option #1	Shows the information of the storage that be installed in the system Choose/set the boot priority

4.7 Save & Exit

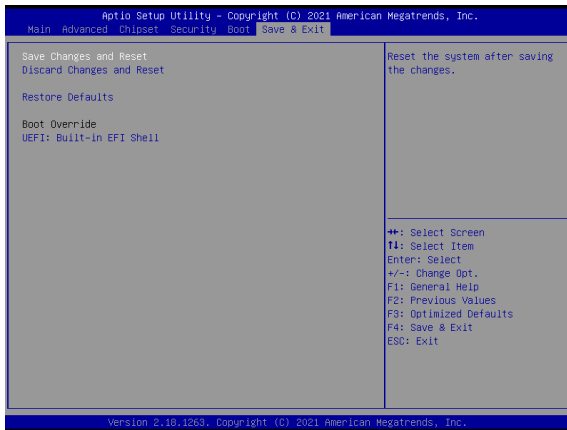

Item	Description
Save Changes and Reset	After configuring all the options that you wish to change, choose this option to save all the changes and reboot the system Yes : Agree to save and reset No : Cancel to save and reset
Discard Changes and Reset	Choose this option to reboot the system without saving any changes Yes : Agree to discard changes and reset No : Cancel to discard changes and reset
Restore Defaults	Restore/Load default values for all the setup options Yes : Agree to load optimized defaults No : Cancel to load optimized defaults