

Industrial 10GbE/TX, 4 GbE/SFP Managed Switch

JetNet 7014G

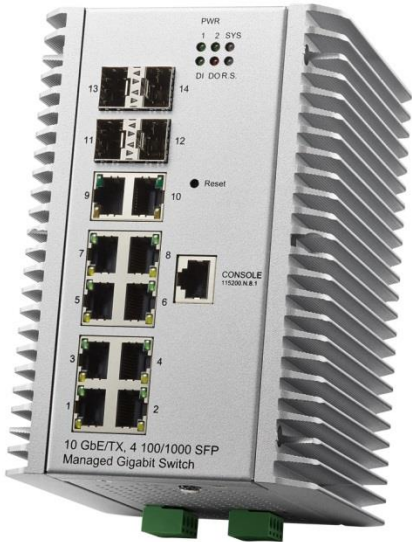

The JetNet 7014G is an pure Gigabit industrial Ethernet Switch with 10 ports RJ-45, 4 ports Gigabit SFP socket for optical fiber network connection. It adopts high efficiency Ethernet MAC controller with 40Gbps Switch fabric bandwidth, 9K jumbo frame forwarding and powerful Layer-3 IP routing capability. The robust system design makes the JetNet 7014G survive under harsh outdoor environment with extreme electric magnetic interference and the variation of environment temperature. The hardware switching basis Layer-3 Routing features enabled the IP based packet forwarding with high performance, low latency and security. It provides your network infrastructure with great performance and safety with network access control, and handle burst packet with smart buffer management for IP surveillance in real infrastructure.



EN50121-4



Heavy Industrial



Cyber Redundancy



Gigabit



Cyber Security



IEEE1588 PTP

Features

- ▶ 10 Gigabit Ethernet RJ-45 ports ,4 Gigabit SFP ports
- ▶ 1000Mbps Fiber Connection with DDM function
- ▶ Non-Blocking, High Speed Network Switching Fabric
- ▶ Network Redundancy - MSR (Multiple Super Ring),ITU-T G.8032 ERPS, RSTP, MSTP, Super Chain
- ▶ Fully Device Management - SNMP v1/v2c/v3, RMON, Web UI, Telnet and Local Console
- ▶ Friendly Device and Network Topology recovery utility - Korenix View, Korenix NMS
- ▶ Advanced Cyber Network Security -MAC security, IEEE 802.1x Port Based access control , IEEE 802.1x Radius Server authentication, 802.1x MAB, Distributed Denial of Service (DDoS), IP Source Guard, Denial of ARP Inspection
- ▶ Layer 2 Network Performance - IEEE802.1Q VLAN, Private VLAN, Trunk, Packet Filtering, DHCP Server/Client, Traffic Prioritize, Rate Control
- ▶ Layer 3 Network Routing Protocols - RIP v1/v2, OSPF, VRRP, IP Multicasting
- ▶ Hardware Watchdog for System Auto-Recovery
- ▶ High Level Electromagnetic interference immunity
- ▶ IP Surveillance solution with NEMA-TS2 characteristic
- ▶ Railway Track Side EN50121-4 compliance
- ▶ High Operating Temperature - -40-75°C
- ▶ Redundant wide range power input- DC 10-36V

High Performance Data Acquisition

The Ethernet Switch designed with high port density interface for field data acquisition, and exchange with data center. With the highest Switch Fabric and data buffer, the JetNet 7014G approached seamless connective for field and center offered 9Kbytes packet forwarding ability and excellent burst stream management technology to enable highest network performance.

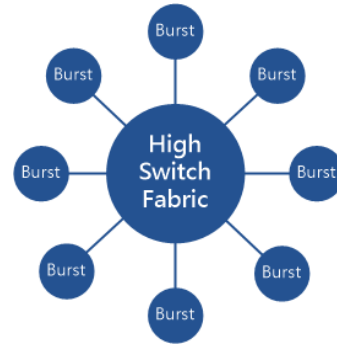

Flexible Uplink Media for Network Architecture Extension

In the metro network architecture, the optical fiber is commonly to use for uplink connection. The JetNet 7014G supports 4 SFP interfaces with hot-swappable, Plug & Play, and smart transceiver recognize technology to approach reliable, flexible and enlarge optical network infrastructure. The Plug and Play characteristics makes user easily change the SFP transceiver for longer communication distance or higher speed connection without any pre-configuration.

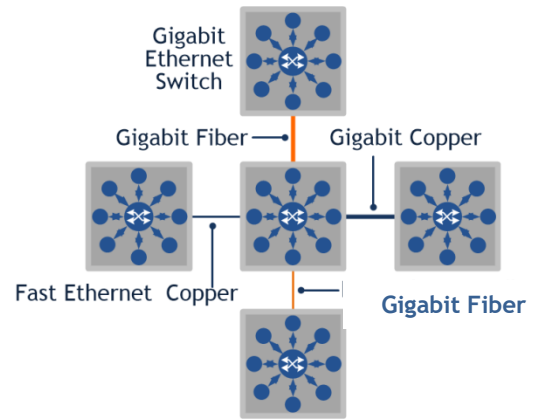

Fiber Optical Quality Monitoring

The fiber optical transmission quality may become unstable, due the moisture, dust or laser diode senile.

To reduce the threat of signal broken, the Ethernet Switch provides Digital Diagnostic Monitoring (DDM) to recognize the specification of fiber transceiver. The DDM function enabled user to monitor the launched power, received signal strength, temperature and also alerts user if fiber signal quality getting poor.

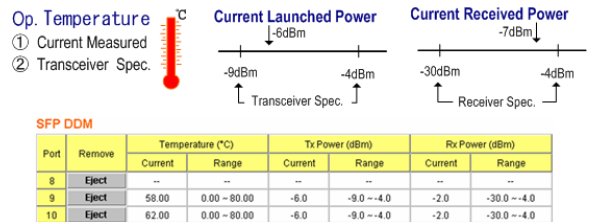

Cyber Network Redundancy

In the Industrial network communication, the reliability of communication always is the critical issue. The JetNet 7014G adapts new network redundancy technology - Cyber Network Redundancy includes MSR, Super Chain, ERPS and IEEE standards-RSTP/MSTP technologies to ensure network reliability. The MSR is a seamless network redundant technology, which includes various technologies for different network redundancy topologies and applications. It includes Rapid Super Ring (RSRTM), Rapid Dual Homing (RDHTM), MultiRingTM and TrunkRingTM. With those network redundant technologies, a node can be configured to multiple rings with failover time less than 50ms, and zero of restoration time.

MSR Multiple Super Ring

Rapid Super Ring

- RM Auto-Select
- Seamless Restoration
- mSec Recovery Time
- Failed Ring Port Together with RM
- Ring Failure LED

MultiRing

- Ring coupling in one unit
- 7 Gigabit Rings

Rapid Dual Homing

- Multiple Uplink Path
- One to One upper
- Many to One upper
- One to Many upper
- Seamless Restoration

TrunkRing

- Active with Port trunk/LACP with MSR, RSR
- Load Balancing
- Auto Backup

Rapid Super Ring (RSR™) Technology

The Rapid Super Ring (RSR™) technology provides advanced Ring Redundancy Technology, its shortest recovery time is from 50ms to few mini second for Fast Ethernet copper/fiber rings, and the Ring-Master (R.M.) can be auto-selected by RSR™ engine. One of Ring path of R.M. is primary path, the other is block path for standby. Once the primary path failed, the 2nd path will be recovered within few mini second. Besides, the restoration time is shortened to zero in R.M. auto-selection mode.

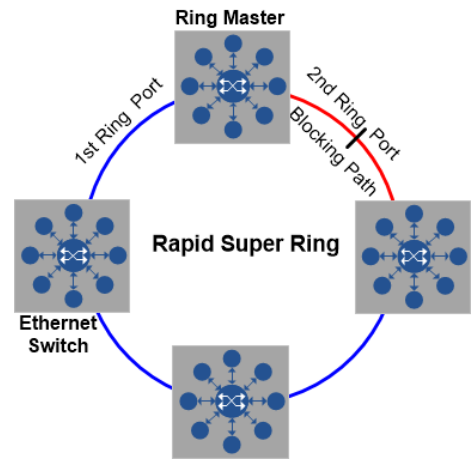

Rapid Dual Homing (RDH™) Technology

The Rapid Dual Homing (RDH™) is designed to engaged Korenix Rapid Super Ring and other vendors Ethernet Switch. It provides easy configuration and multiple redundancies, the failover time is fast than RSTP, and restoration time is zero. Uplinks can be auto detected, and gathered into groups. Each group path are sorted into primary, secondary, and standby. The Link aggregation is also integrated into RDH™. An uplink can be a single or several links as a trunk , which provides better redundancy and capacity.

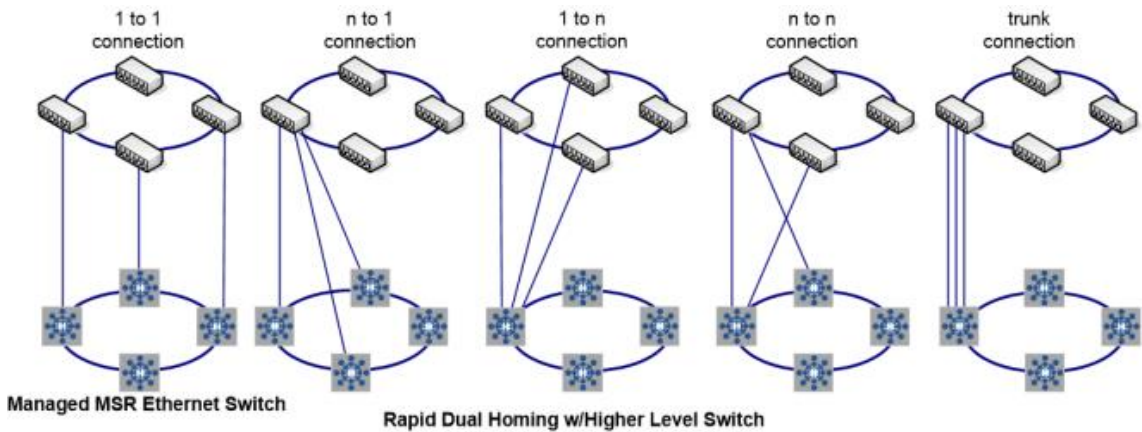

TrunkRing Technology

The TrunkRing is the combination of two technology of RSR and the link aggregation, and takes the advantage of aggregation to increase the path bandwidth. The ring links can be either asymmetric or symmetric. The ring will open only if all the links are broken, and users can enhance the redundancy at different location in accordance to be the need, the path with less bandwidth is more likely to be used as the backup path for restoring the network to full play capacity.

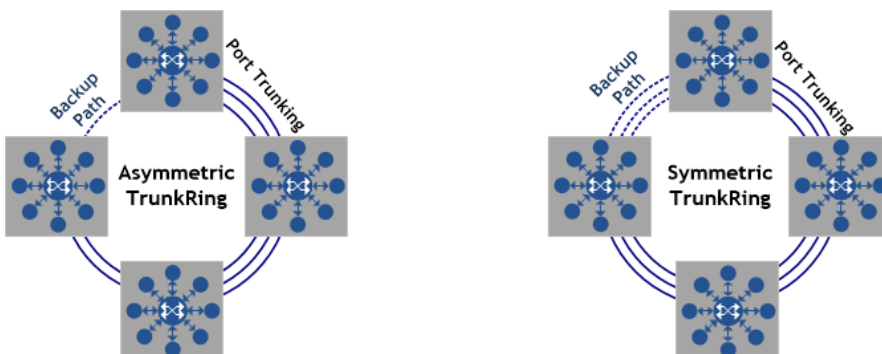

MultiRing Technology

The MultiRing™ provides easier connectivity between two or more ring networks. The simplest sample is to connect two rings by single device. User can extend the network by linking multiple rings into a line or multiple directions. The MultiRing™ has great diversity of various ring technology, when MultiRing™ enabled, the Switch can connect TrunkRing™, RSR™ together and simultaneously provide more high speed ring connectivity. It provides extensibility while keeping the great compatibility.

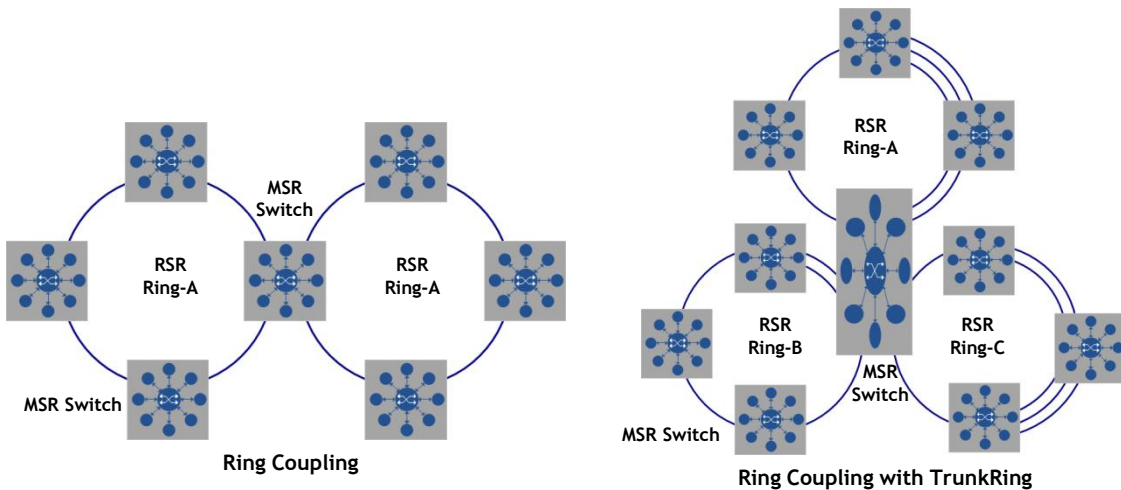

Super Chain Technology

The Super Chain is a new Ring technology that provides a cost-effective way to ring nodes with presented ring to approached flexible, scalability and easy construction.

The Super Chain includes 2 borders that connect with other ring by edge port, and the reset nodes are member. Once the ring broken, the standby edge port will backup in few mini seconds, and seamless restoration time when the broken path recovery. Besides, users can add new super ring with existed super ring to approach the flexibility to saving the construction cost.

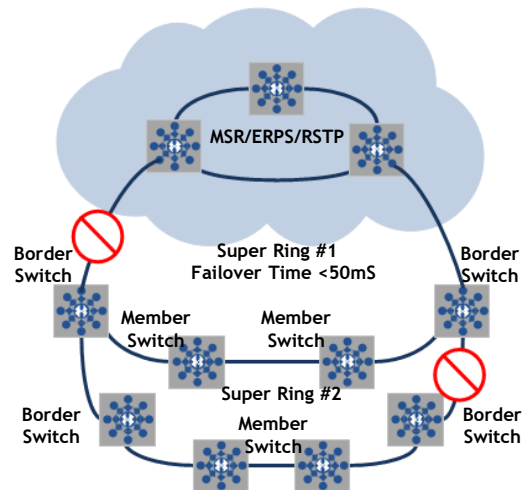

Seamless Ring Port Restoration

Seamless restoration can restore a failed ring without causing any loop problem, topology change and packet loss. With a zero second restoration time, this mechanism eliminates any unstable status and guarantees the applications running non-stop. It ensure MSR™ Ring can harmonic with RSTP protocol. In the figure, the RM will change to another one which nearby the broken path.

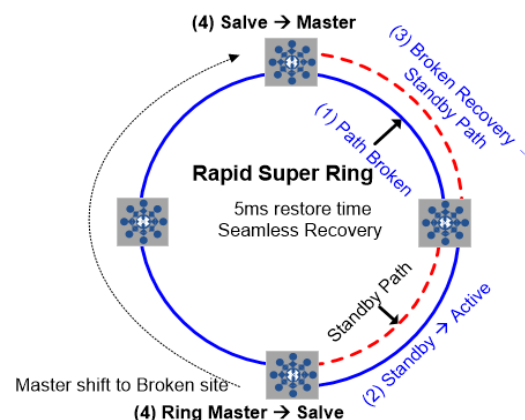

ITU-T G.8032 ERPS

The ITU-T G.8032 Ethernet Ring Protection Switching (ERPS) is a ring technology defined by ITU-T. It includes 2 version ring protocols, ERPS v1 and v2. The v1 supports single ring, and v2 is based on VLAN concept to construct comprehensive ring architecture that engaged several major rings and sub ring. The ERPS protocol is similar as MSR technology with one major host -RPL Owner and several of RPL nodes. The ring restoration and recovery time of ERPS is smaller than 50ms, and slow than MSR. However, the ERPS is an open Ethernet ring redundant protocol that enabled different vendor's ring switch can be integrated together with great network redundancy.

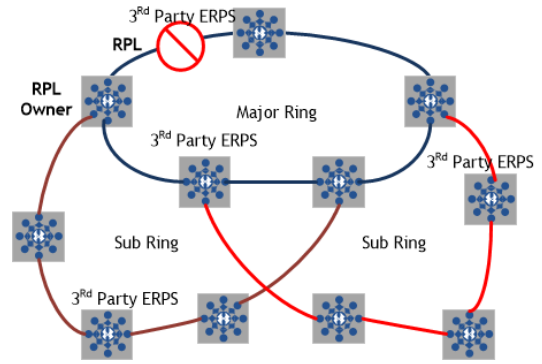

Advanced Cyber Network Security

The JetNet Switch supports several advanced network security functions to ensure the IT system and data will not get any threat from Cyber network (Internet). The advanced security function includes DHCP Snooping protection, Dynamic ARP inspection (DAI), IP source guard (IPSG), Distribute Denial-of-Service protection and IEEE 802.1x MAB.



DHCP Snooping Protection

The DHCP Snooping is a series of techniques applied to the security of an existing DHCP network. With the DHCP Snooping, the DHCP Server will manage the network access and permit the access with specific IP and specific MAC address from specific Switch port can access the network. It also provides the protection to avoid the intruder added fake DHCP server into secure network, and try to take over DHCP process. Once the Switch detects the phenomena, the port of intruder connected will be lock to protect network access.

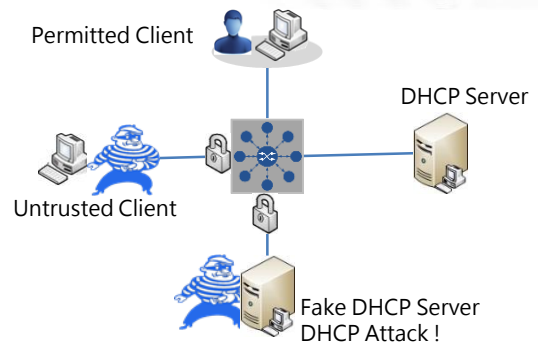

Dynamic ARP inspection Protection

The Dynamic ARP Inspection (DAI) is a security feature that prevents ARP attack. The Switch receives one ARP packet on an untrusted port, the switch compares the IP-to-MAC address binding with entries from the DHCP Snooping database or ARP access-lists. If there is no match, the ARP packet will be dropped by the Switch to ensure network performance.

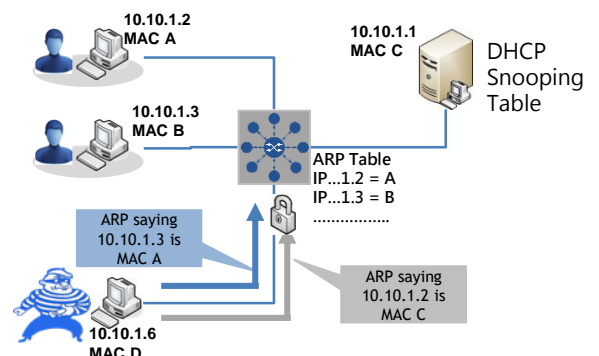

IP Source Guard (IPSG)

IP Source Guard is a security feature that restricts IP traffic on untrusted Switch port by filtering traffic based on the DHCP snooping binding database or manually configured IP source bindings. This feature helps prevent IP spoofing attacks when a host tries to spoof and use the IP address of another host.

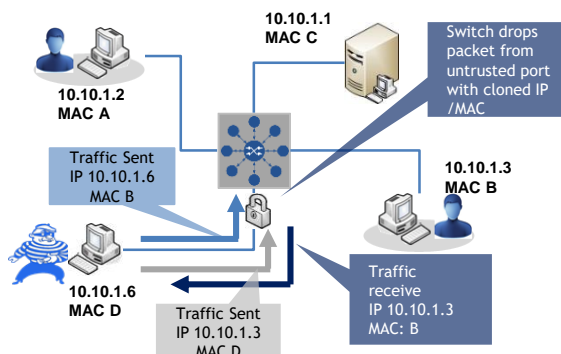

Denial of Service (DoS) Prevention

In the internet, a Denial of Service (DoS) or Distributed Denial-of-service (DDoS) attack is an attempt to make a computer or network resource unavailable for intended operating. For the managed Ethernet Switch, the attacker may send lot of service inquire packets to the Switch, and it may caused Switch's CPU get slowly and the network may malfunction. With the DoS protection, the Switch will far way the treat of zombie computer, and keep the network operating as well.

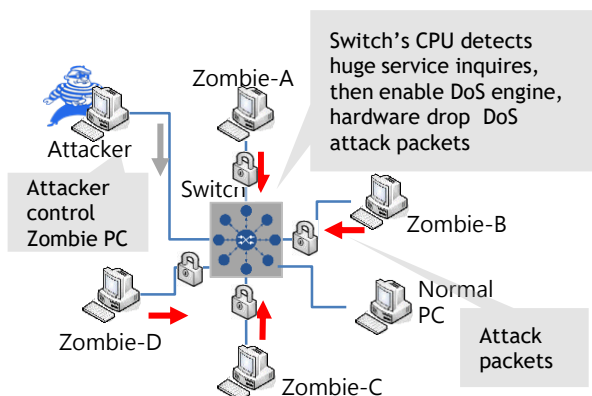

IEEE802.1x MAB

The 802.1x MAB provides the feature to assist remote device which can't support 802.1x access control authentication, but still need connect to a secure network. The Switch can active as 802.1x agent to perform RADIUS-Access-Request after 802.1x time out and Switch learned MAC address.

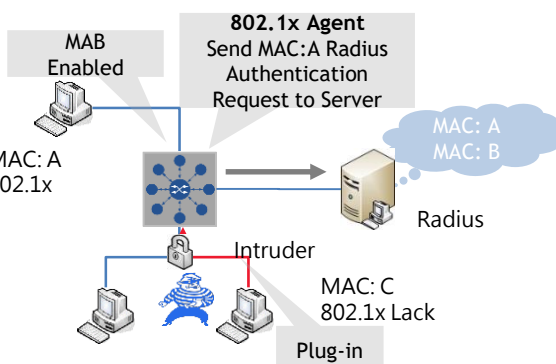

Advanced Layer 2 plus Access Security

In some of industrial automation fields, the advanced network security features are required and must be implemented into field devices. The secured Access Control List (ACL) makes it easy to limit certain communication with other addressed devices by the specific protocol. The ACLs provide "Permit" and "Deny" rules for any or specific host. The Source/Destination MAC address, global IP address or extend IP address with protocol type could be applied as the rules to secure the network from field site access.

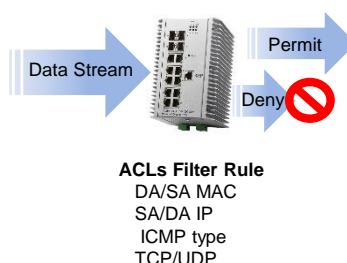

Survival in Harsh Environment

The JetNet 7014G adopts excellent heat dissipation design to operating in -40~75°C environment , and also supports high grade EMC protection to bear those out-door applications. The switch can be located at harsh environment with extreme temperature and interference of electric noise.

Condition	Performance
Temperature	-40~75°C
ESD Contact/Air	6KV/8KV, Criteria A Level-3 Testing Severity
Surge /Lighting Attack	2KV at Power, Ethernet Level-3 Testing Severity
Electric Transient	2KV at Power, Ethernet Level-3 Testing Severity
Railway Track Side Application	Compliance EN50121-4

Layer-3 Routing - Accelerates Data Stream in Complex-Network

The Routing is the process of moving packets between different IP address domain or forward to internet. To forward traffic, a router or a Layer-3 Switch need to know the Destination/ Source IP address, the possible and best routes, and verifying /maintain the routing information. The JetNet 7014G offers various of Layer-3 features- Static/ Dynamic routing, VLAN routing, IP Multicasting routing, VRRP and OSPF routing. With those routing function, the Switch can route IP stream in quick and efficiency with high speed scalability, low latency, flow accountable and security as well as.

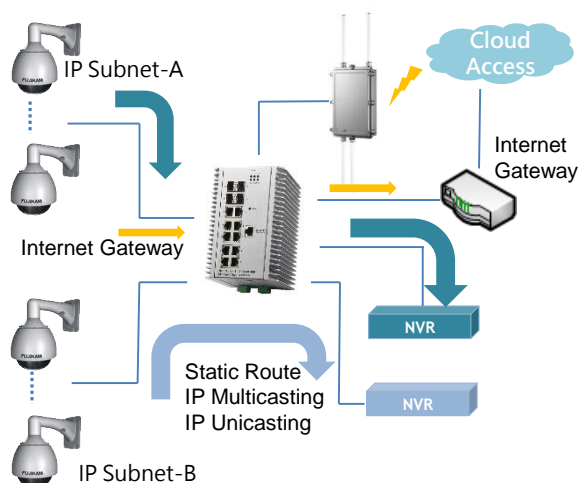

Specification

Technology	
Standard	IEEE 802.3 10 Base-T Ethernet IEEE 802.3u 100 Base-TX Fast Ethernet IEEE 802.3ab 1000 Base-T IEEE 802.3z Gigabit Ethernet Fiber IEEE 802.3x Flow Control and Back-pressure IEEE 802.1AB Link Layer Discovery Protocol (LLDP) IEEE 802.1p Class of Service (CoS) IEEE 802.1Q VLAN and GVRP IEEE 802.1D-2004 Rapid Spanning Tree Protocol (RSTP) IEEE 802.1s Multiple Spanning Tree Protocol (MSTP) IEEE 802.3ad Link Aggregation Protocol (LACP) IEEE 802.1x Port Based Network Access Protocol ITU-T G.8032 ERPS
Performance	
Switch Technology	Store and Forward Technology with Non-Blocking Switch Fabric
CPU performance	32 bits CPU with Hardware based Watch-dog timer with 10S reset timer
System Memory	32M bytes flash ROM, 256M bytes system RAM.
Transfer packet size	64 bytes to 9K bytes Jumbo Frame
Packet Buffer	1.5MBytes shared memory for packet buffer with intelligent memory management unit for burst data traffic
Transfer performance	14,880pps for Ethernet and 148,800 for Fast Ethernet, 1488,100 for Gigabit Ethernet

Management	
Management Interface	Telnet with SSH, Web Browser with SSL, SNMP V1/V2c/V3 with SNMP Trap (up to 4 trap stations), RMON (Group 1,2,3,9) for in-band management. Local RS-232 connector for out-band management
Management Security	The maximum management session up to four, and support management Host IP secure feature to prevent unauthorized remote login
SNMP MIB	MIB-II, Bridge MIB, Ethernet-like-MIB, VLAN MIB, Private MIB
NMS	Windows based NMS (Network Management System) -Korenix NMS and Korenix View for device discovery and topology map auto construct
Network Time Protocol	NTP with daylight saving and localize time sync function
Management IP Security	Predefined Host IP address for management host login security
E-mail Warning	4 Receipt E-mail accounts with E-mail server authentication
System Event Log	2 Event log record modes- Local and remote Log Server with authentication
Network Performance	
Port Configuration & Statistic	Port link Speed, Link mode, flow control, port statistics
Port Trunk	IEEE 802.3ad Link Aggregation Control Protocol (LACP) and Static port trunk; trunk member up to 8 ports in one group, maximum 7 trunk groups
VLAN	IEEE 802.1Q Tag VLAN with 256 VLAN Entries and provides 2K GVRP entries; 3 VLAN link modes- Trunk mode, Hybrid mode and Link access mode
Private VLAN	The Private VLAN is special for group uplink access with independent port security. With the private VLAN function, each VLAN community is isolated and only exchange by high level device with primary VLAN community
IEEE 802.1Q QinQ	Supports Double VLAN tag for VLAN isolation and security
IEEE 802.1p	The Ethernet Switch MAC controller supports IEEE 802.1p Class of Service function; Per interface with 8 queues
IGMP Snooping	IGMP Snooping v1/v2 /v3 for multicast filtering and IGMP Query mode; also support unknown multicasting process forwarding policies- drop, flooding and forward to router port
Rate Control	Ingress/Egress filtering for broadcast, multicast, unknown DA or all packets
Port Mirroring	On-line traffic monitoring on multiple selected ports
DHCP	System supports DHCP Client function for dynamic IP address obtain from DHCP Server, and the Switch also support DHCP Server function with DHCP Relay Agent to forward DHCP request through specified forwarding path. The DHCP Server also offer port based DHCP Server function with predefined IP address or perform MAC&IP address binding function
IEEE 802.1x/ Port Security	Port based network access control, and authenticated by localize pre-defined MAC address or remote RADIUS Server
Cyber Network Redundancy	
Multiple Super Ring (MSR™)	New generation Korenix Ring Redundancy Technology, Includes Rapid Super Ring, Rapid Dual Homing, TrunkRing™, MultiRing™, Super Chain™
Rapid Dual Homing (RDH™)	Multiple uplink paths to one or multiple upper Switch, up to 256 Groups RDH™ Peer protection
TrunkRing™	Integrate port aggregate function in ring path to get higher throughput ring architecture
MultiRing™	Supports redundant ring up to 7 Gigabit rings in one device
Super Chain	It is new ring technology with flexible and scalability, compatibility, and easy configurable. The ring includes 2 types of node Switch - Border Switch and Member Switch
Rapid Spanning Tree	IEEE 802.1D-2004 Rapid Spanning Tree Protocol; it compatible with Legacy Spanning Tree and IEEE 802.1w

Multiple Spanning Tree	IEEE 802.1s Multiple Spanning Tree, each MSTP instance can include one or more VLANs, and also supports multiple RSTP deployed in a VLAN or multiple VLANs
ITU-T G.8032 ERPS *Note-1	Support ITU-T G.8032 ERPS V1 single ring topology, and ERPS v2 multiple rings with ladder topology
Cyber Security *Note-2	The Cyber Security function includes- DHCP Snooping protection, Dynamic ARP inspect protection, IP Source Guard (IPSG), Distribute Denial-of-Service (DDoS), IEEE 802.1x MAB for non-IEEE 802.1x compliant device.
Industrial Protocol	Modbus/TCP, Ethernet/IP
Routing Protocols	
IP Routing	Supports Default Static and Dynamic Route
Virtual LAN Routing	Incorporate both of IEEE802.1Q Bridge and Routing Function
Routing Information Protocol	Hop-Based IP Routing with RIPv1 and RIPv2
OSPF	Link State based IP routing protocol support OSPFv1 and OSPFv2 (2 nd stage)
IGMP	Multicast Group Management Protocol support IGMP v1,v2
Multicast Routing	128 IP Multicast Routing entries
VRRP	Short of Virtual Route Redundancy Protocol, Automatically Backup Routing route to specified router
Interface	
Enclosure Port	1000Mbps Gigabit Ethernet port (#1-#10): 10 x RJ-45 Connectors 1000Mbps Gigabit Ethernet SFP port (#11-#14): SFP Socket with 1000Mbps Fiber Transceiver Auto Detection, and with Digital Diagnostic Monitoring (DDM) for optical fiber quality inspection Power input: 4-Pin Removable Terminal Block Connector Digital Input, Output: 4-Pin Removable Terminal Block Connector RS-232 Console: RJ-45, Baud Rate:115200bps, N,8,1 Digital Input: Semi Digital Input (Low: 0-10V, High:11-30V) Digital Output: Dry Relay Output with Normal Open operating mode with DC 24V/0.5A contact capability
Cables	100Base-TX: 2 pairs STP Cat.5e/Cat.6 cable, EIA/TIA-568B 100-ohm (length:100Meters) 1000Base-T: 4 pairs STP Cat. 5e/Cat.6 cable, EIA/TIA-568B 100-ohm (length:100Meters) Power Cable: Recommended uses 18AWG electrical power cable with UL certification
Diagnostic Indicator	1000Mbps RJ-45 port: Link/Acrivity (Green on, Green Blinking),1000M (Amber on) 1000Mbps SFP: Link/Activity (Green on, Green Blinking), 1000Mbps (Amber on) Power: Power on (Green on) Sys: Ready (Green on) R.S: Green on (Ring Normal)/Blinking (wrong ring port connective), Amber on (Ring abnormal)/Blinking (ring port failed) D.I.: Digital Input (Green on) D.O.: Dry Relay Output (Red on)
Power Requirement	
System Power	Typical Power Input: DC 24V, Range: 9-36V
Power Consumption	DC 9V: 13.95W DC 24V: 14.16W DC 36V:13W
Mechanical	
Installation	EN50022 DIN Rail Mount
Dimensions	108 mm (W) x 160 mm (H) x 136 mm (D)-with mounting ears 108 mm (W) x 160 mm (H) x 127 mm (D)-without mounting ears
Material Housing	Steel Metal with Aluminum Housing
Ingress Protection	IP-31
Environmental	
Operating temperature	-40-75°C
Operating humidity	0%-95%, non-condensing
Storage Temperature	-40-85°C, 0%-95% humidity

Hi-Pot

Power- Chassis GND/Housing: AC 1KV/DC 1.4KV

Regulatory Approvals

Railway Application

Rolling Stock Track Side EN50121-4

EMC

EMI: IEC/EN61000-6-2, Compliance with EN50121-1/-4 , CE class A, FCC sub part-15 class-A

EMS: IEC/EN61000-6-4, Compliance with EN50121-1/-4, EN61000-4-2/-4-3/-4-4/-4-5/-4-6/-4-8/-4-9

Vibration & Shock

Compliance with IEC 61373

* Note-1: ITU-T ERPS V2 (By Request)

* Note-2: Cyber Security (By Request)

Dimension (Unit = mm)

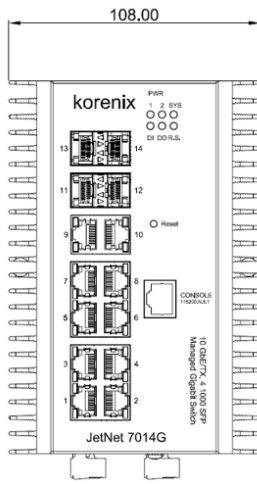

Front View

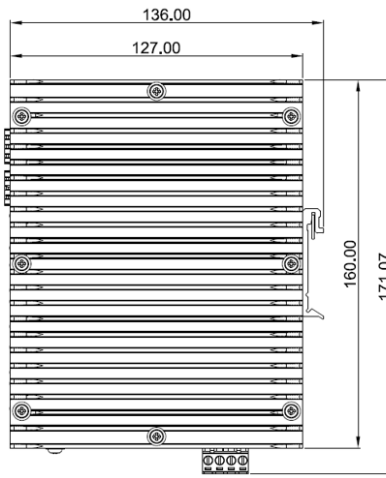

Right Side View

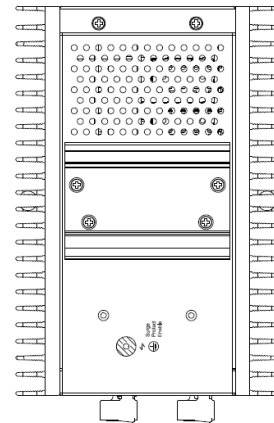

Rear Side View

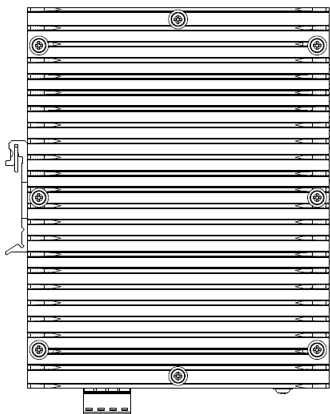

Left Side View

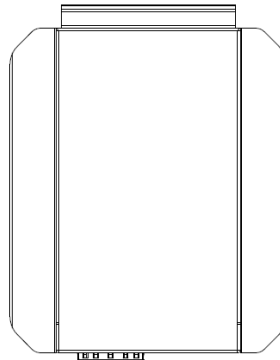

Top Side View

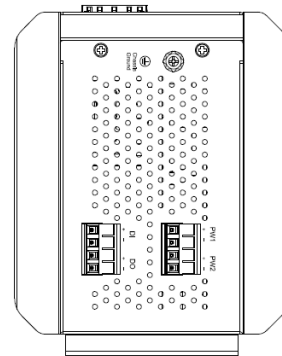

Bottom View

Ordering Information

JetNet 7014G Industrial 10GbE/TX, 4 GbE/SFP Managed Switch, -40-75°C

Each Unit include:

- ▶ JetNet 7014G x1
- ▶ Quick Installation Guide
- ▶ DIN Rail Mounting kit

Optional Accessories

Mounting Kit	
MTK-W-143	Mounting Kit, Wall-mount plate, 143x38mm
MTK-RD-130	Mounting Kit, Robust DIN rail adapter, 130x52mm