

Datasheet

M.2 (P42) 3TE2 series

- PCIe Gen. III x2, NVMe 1.3
- Excellent data transfer speed
- Zero mechanical interference
- LDPC ECC engine supported.
- End-to-end Data Path Protection



Introduction

Innodisk M.2 (P42) 3TE2 is an NVM Express DRAM-less SSD designed as the standard M.2 form factor with PCIe interface. M.2 (P42)3TE2 supports PCIe Gen III x2, and it is compliant with NVMe 1.3 providing excellent performance. Moreover, it adopts industrial 3D TLC NAND Flash providing high endurance and reliability. With sophisticated error detection and correction (ECC) functions, the module can ensure full End-to-end Data Path Protection that secures the data transmission between host system and NAND Flash.

Innodisk M.2 (P42) 3TE2 is integrated with Marvell controller which provide both low power consumption and efficient heat dissipation, making the SSD optimal for space-constrained IPCs and server boot-up applications.

M.2 (P42) 3TE2 series

Diagram

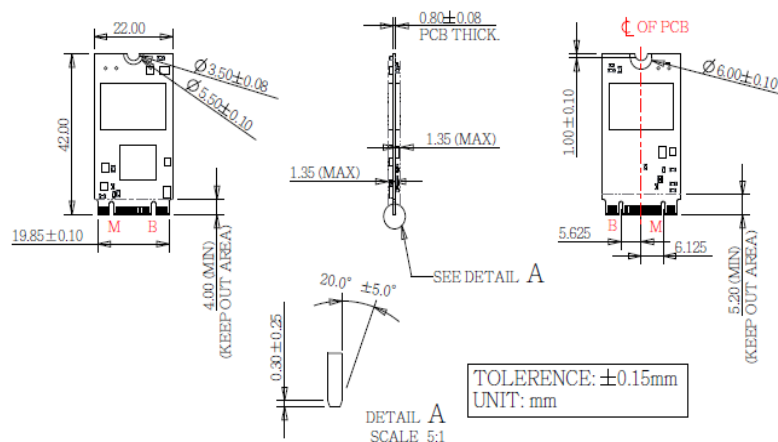

Contact us for more information about the M2 (P42) 3TE2.

Innodisk is a service-driven provider of industrial embedded flash and DRAM storage products and technologies, with a focus on the cloud computing, industrial/embedded, and aerospace and defense industries.

Headquarters (Taiwan)

5F., No. 237, Sec. 1, Datong Rd., Xizhi Dist., New Taipei City 221, Taiwan
Tel: +886-2-7703-3000
Email: sales@innodisk.com

Branch Offices:

USA
usasales@innodisk.com
+1-510-770-9421

Europe
eusales@innodisk.com
+31-40-3045-400

Japan
jpsales@innodisk.com
+81-3-6667-0161

China
sales_cn@innodisk.com
+86-755-21673689

www.innodisk.com

© 2019 Innodisk Corporation.
All right reserved. Specifications are subject to change without prior notice.

20190227

Specifications

Interface	PCIe Gen. III x2
Flash Type	3D TLC
P/E cycle	3,000
Capacity	64GB~512GB
Max. Channels	4
Sequential R/W (MB/sec, max.)	1400/700
Max. Power Consumption	2.31W(3.3V x700mA)
Thermal Sensor	√
External DRAM buffer	-
H/W Write Protect	-
Dimension (WxLxH)	22.0 X 42.0 X 3.5 mm
Environment	Vibration: 20G @7~2000Hz Shock: 1500G @ 0.5ms Storage Temperature: -55°C ~ +95°C MTBF: 3,000,000 hour

Ordering Information

Operation Temp.	64GB	128GB	256GB	512GB
Standard Grade (0°C ~ +70°C)	DEM24-64GM61ECADF	DEM24-A28M61ECAQF	DEM24-B56M61ECAQF	DEM24-C12M61ECAQF
Industrial Grade (-40°C ~ +85°C)	DEM24-64GM61EWADF	DEM24-A28M61EWAQF	DEM24-B56M61EWAQF	DEM24-C12M61EWAQF