



NEXCOM International Co., Ltd.

Network and Communication Solutions
Fixed Wireless Access Telecom Appliance
FTA 5180 Series
User Manual

CONTENTS

Preface

Copyright	iv
Disclaimer	iv
Acknowledgements	iv
Regulatory Compliance Statements	iv
Declaration of Conformity	iv
RoHS Compliance	v
Warranty and RMA	vi
Safety Information	viii
Installation Recommendations	viii
Safety Precautions	ix
Technical Support and Assistance	x
Conventions Used in this Manual	x
Global Service Contact Information	xi
Package Contents	xiii

Chapter 1: Product Introduction

Overview	1
Key Features	1
Hardware Specifications	2
Knowing Your FTA5180	3
Front Panel	3
Rear Panel	4

Chapter 2: Jumpers and Connectors

Before You Begin	5
Precautions	5
Jumper Settings	6
Locations of the Jumpers and Connectors	7
Jumpers	8
RTC Clear	8
Connector Pin Definitions	9
External I/O Interfaces	9
Power LED	9
PoE LED	9
Internal Connectors	10
PoE Header	10
PWM Controller SMBUS Header	10
LCM (Reserved)	11
Fan Wafer Connector	11
Internal Power Connector	12
Internal Power Connector	12
Internal Power Connector	13
Power signal to power supply	13
SYS RTC Holder	14
UART from CPLD (Reserved)	14
JTAG header from CPLD or BMC select	15
BMC UART Debug	15



IDV connector (For Debug)	16
System Power Button Header	16
CPLD JTAG	17
VGA	17
XDP Connector (For Debug)	18
Block Diagram	19

Chapter 3: BIOS Setup

About BIOS Setup	20
When to Configure the BIOS	20
Default Configuration	21
Entering Setup	21
Legends	21
BIOS Setup Utility	23
Main	23
Advanced	24
Security	54
Boot	54
Save & Exit	55

PREFACE

Copyright

This publication, including all photographs, illustrations and software, is protected under international copyright laws, with all rights reserved. No part of this manual may be reproduced, copied, translated or transmitted in any form or by any means without the prior written consent from NEXCOM International Co., Ltd.

Disclaimer

The information in this document is subject to change without prior notice and does not represent commitment from NEXCOM International Co., Ltd. However, users may update their knowledge of any product in use by constantly checking its manual posted on our website: <http://www.nexcom.com>. NEXCOM shall not be liable for direct, indirect, special, incidental, or consequential damages arising out of the use of any product, nor for any infringements upon the rights of third parties, which may result from such use. Any implied warranties of merchantability or fitness for any particular purpose is also disclaimed.

Acknowledgements

FTA5180 is a trademark of NEXCOM International Co., Ltd. All other product names mentioned herein are registered trademarks of their respective owners.

Regulatory Compliance Statements

This section provides the FCC compliance statement for Class B devices and describes how to keep the system CE compliant.

Declaration of Conformity

FCC

This equipment has been tested and verified to comply with the limits for a Class B digital device, pursuant to Part 15 of FCC Rules. These limits are designed to provide reasonable protection against harmful interference when the equipment is operated in a commercial environment. This equipment generates, uses, and can radiate radio frequency energy and, if not installed and used in accordance with the instructions, may cause harmful interference to radio communications. Operation of this equipment in a residential area (domestic environment) is likely to cause harmful interference, in which case the user will be required to correct the interference (take adequate measures) at their own expense.

CE

The product(s) described in this manual complies with all applicable European Union (CE) directives if it has a CE marking. For computer systems to remain CE compliant, only CE-compliant parts may be used. Maintaining CE compliance also requires proper cable and cabling techniques.

RoHS Compliance



NEXCOM RoHS Environmental Policy and Status Update

NEXCOM is a global citizen for building the digital infrastructure. We are committed to providing green products and services, which are compliant with European Union RoHS (Restriction on Use of Hazardous Substance in Electronic Equipment) directive 2011/65/EU, to be your trusted green partner and to protect our environment.

RoHS restricts the use of Lead (Pb) < 0.1% or 1,000ppm, Mercury (Hg) < 0.1% or 1,000ppm, Cadmium (Cd) < 0.01% or 100ppm, Hexavalent Chromium (Cr6+) < 0.1% or 1,000ppm, Polybrominated biphenyls (PBB) < 0.1% or 1,000ppm, and Polybrominated diphenyl Ethers (PBDE) < 0.1% or 1,000ppm.

In order to meet the RoHS compliant directives, NEXCOM has established an engineering and manufacturing task force in to implement the introduction of green products. The task force will ensure that we follow the standard NEXCOM development procedure and that all the new RoHS components and new manufacturing processes maintain the highest industry quality levels for which NEXCOM are renowned.

The model selection criteria will be based on market demand. Vendors and suppliers will ensure that all designed components will be RoHS compliant.

How to recognize NEXCOM RoHS Products?

For existing products where there are non-RoHS and RoHS versions, the suffix "(LF)" will be added to the compliant product name.

All new product models launched after January 2013 will be RoHS compliant. They will use the usual NEXCOM naming convention.

Warranty and RMA

NEXCOM Warranty Period

NEXCOM manufactures products that are new or equivalent to new in accordance with industry standard. NEXCOM warrants that products will be free from defect in material and workmanship for 2 years, beginning on the date of invoice by NEXCOM.

NEXCOM Return Merchandise Authorization (RMA)

- Customers shall enclose the “NEXCOM RMA Service Form” with the returned packages.
- Customers must collect all the information about the problems encountered and note anything abnormal or, print out any on-screen messages, and describe the problems on the “NEXCOM RMA Service Form” for the RMA number apply process.
- Customers can send back the faulty products with or without accessories (manuals, cable, etc.) and any components from the card, such as CPU and RAM. If the components were suspected as part of the problems, please note clearly which components are included. Otherwise, NEXCOM is not responsible for the devices/parts.
- Customers are responsible for the safe packaging of defective products, making sure it is durable enough to be resistant against further damage and deterioration during transportation. In case of damages occurred during transportation, the repair is treated as “Out of Warranty.”
- Any products returned by NEXCOM to other locations besides the customers’ site will bear an extra charge and will be billed to the customer.

Repair Service Charges for Out-of-Warranty Products

NEXCOM will charge for out-of-warranty products in two categories, one is basic diagnostic fee and another is component (product) fee.

System Level

- Component fee: NEXCOM will only charge for main components such as SMD chip, BGA chip, etc. Passive components will be repaired for free, ex: resistor, capacitor.
- Items will be replaced with NEXCOM products if the original one cannot be repaired. Ex: motherboard, power supply, etc.
- Replace with 3rd party products if needed.
- If RMA goods can not be repaired, NEXCOM will return it to the customer without any charge.

Board Level

- Component fee: NEXCOM will only charge for main components, such as SMD chip, BGA chip, etc. Passive components will be repaired for free, ex: resistors, capacitors.
- If RMA goods can not be repaired, NEXCOM will return it to the customer without any charge.

Warnings

Read and adhere to all warnings, cautions, and notices in this guide and the documentation supplied with the chassis, power supply, and accessory modules. If the instructions for the chassis and power supply are inconsistent with these instructions or the instructions for accessory modules, contact the supplier to find out how you can ensure that your computer meets safety and regulatory requirements.

Cautions

Electrostatic discharge (ESD) can damage system components. Do the described procedures only at an ESD workstation. If no such station is available, you can provide some ESD protection by wearing an antistatic wrist strap and attaching it to a metal part of the computer chassis.

Safety Information

Before installing and using the device, note the following precautions:

- Read all instructions carefully.
- Do not place the unit on an unstable surface, cart, or stand.
- Follow all warnings and cautions in this manual.
- When replacing parts, ensure that your service technician uses parts specified by the manufacturer.
- Avoid using the system near water, in direct sunlight, or near a heating device.
- The load of the system unit does not solely rely for support from the rackmounts located on the sides. Firm support from the bottom is highly necessary in order to provide balance stability.
- The computer is provided with a battery-powered real-time clock circuit. There is a danger of explosion if battery is incorrectly replaced. Replace only with the same or equivalent type recommended by the manufacturer. Discard used batteries according to the manufacturer's instructions.

Installation Recommendations

Ensure you have a stable, clean working environment. Dust and dirt can get into components and cause a malfunction. Use containers to keep small components separated.

Adequate lighting and proper tools can prevent you from accidentally damaging the internal components. Most of the procedures that follow require only a few simple tools, including the following:

- A Philips screwdriver
- A flat-tipped screwdriver
- A grounding strap
- An anti-static pad

Using your fingers can disconnect most of the connections. It is recommended that you do not use needle-nose pliers to disconnect connections as these can damage the soft metal or plastic parts of the connectors.

Safety Precautions

1. Read these safety instructions carefully.
2. Keep this User Manual for later reference.
3. Disconnect this equipment from any AC outlet before cleaning. Use a damp cloth. Do not use liquid or spray detergents for cleaning.
4. For plug-in equipment, the power outlet socket must be located near the equipment and must be easily accessible.
5. Keep this equipment away from humidity.
6. Put this equipment on a stable surface during installation. Dropping it or letting it fall may cause damage.
7. The openings on the enclosure are for air convection to protect the equipment from overheating. **DO NOT COVER THE OPENINGS.**
8. Make sure the voltage of the power source is correct before connecting the equipment to the power outlet.
9. Place the power cord in a way so that people will not step on it. Do not place anything on top of the power cord. Use a power cord that has been approved for use with the product and that it matches the voltage and current marked on the product's electrical range label. The voltage and current rating of the cord must be greater than the voltage and current rating marked on the product.
10. All cautions and warnings on the equipment should be noted.
11. If the equipment is not used for a long time, disconnect it from the power source to avoid damage by transient overvoltage.
12. Never pour any liquid into an opening. This may cause fire or electrical shock.
13. Never open the equipment. For safety reasons, the equipment should be opened only by skilled person.
14. If one of the following situations arises, get the equipment checked by service personnel:
 - a. The power cord or plug is damaged.
 - b. Liquid has penetrated into the equipment.
 - c. The equipment has been exposed to moisture.
 - d. The equipment does not work well, or you cannot get it to work according to the user's manual.
 - e. The equipment has been dropped and damaged.
 - f. The equipment has obvious signs of breakage.
15. Do not place heavy objects on the equipment.
16. The unit uses a three-wire ground cable which is equipped with a third pin to ground the unit and prevent electric shock. Do not defeat the purpose of this pin. If your outlet does not support this kind of plug, contact your electrician to replace your obsolete outlet.
17. **CAUTION: DANGER OF EXPLOSION IF BATTERY IS INCORRECTLY REPLACED. REPLACE ONLY WITH THE SAME OR EQUIVALENT TYPE RECOMMENDED BY THE MANUFACTURER. DISCARD USED BATTERIES ACCORDING TO THE MANUFACTURER'S INSTRUCTIONS.**

“ATTENTION: Risque d'explosion si la batterie est remplacée par un type incorrect. Mettre au rebus les batteries usagées selon les instructions.”
18. This equipment is not suitable for use in locations where children are likely to be present.

Cet équipement ne convient pas à une utilisation dans des lieux pouvant accueillir des enfants.
19. Suitable for installation in Information Technology Rooms in accordance with Article 645 of the National Electrical Code and NFPA 75.

Peut être installé dans des salles de matériel de traitement de l'information conformément à l'article 645 du National Electrical Code et à la NFPA 75.
20. Use certified and rated Laser Class I for Optical Transceiver product.

Technical Support and Assistance

1. For the most updated information of NEXCOM products, visit NEXCOM's website at www.nexcom.com.
2. For technical issues that require contacting our technical support team or sales representative, please have the following information ready before calling:
 - Product name and serial number
 - Detailed information of the peripheral devices
 - Detailed information of the installed software (operating system, version, application software, etc.)
 - A complete description of the problem
 - The exact wordings of the error messages

Warning!

1. Handling the unit: carry the unit with both hands and handle it with care.
2. Maintenance: to keep the unit clean, use only approved cleaning products or clean with a dry cloth.

Conventions Used in this Manual



Warning:

Information about certain situations, which if not observed, can cause personal injury. This will prevent injury to yourself when performing a task.



Caution:

Information to avoid damaging components or losing data.



Note:

Provides additional information to complete a task easily.

Global Service Contact Information

Headquarters

NEXCOM International Co., Ltd.

9F, No. 920, Zhongzheng Rd.,
Zhonghe District, New Taipei City, 23586,
Taiwan, R.O.C.
Tel: +886-2-8226-7786
Fax: +886-2-8226-7782
www.nexcom.com

Asia

Taiwan

NexAIoT Headquarters

Industry 4.0 and Cloud Services

13F, No.922, Zhongzheng Rd.,
Zhonghe District, New Taipei City,
23586, Taiwan, R.O.C.
Tel: +886-2-8226-7796
Fax: +886-2-8226-7926
Email: jacobhuang@nexaiot.com
www.nexaiot.com

NexAIoT Co., Ltd.

Taichung Office

16F, No.250, Sec.2, Chongde Rd.,
Beitun District,
Taichung City, 406, Taiwan, R.O.C.
Tel: +886-4-2249-1179
Fax: +886-4-2249-1172
Email: jacobhuang@nexaiot.com
www.nexaiot.com

NexCOBOT Taiwan Co., Ltd.

13F, No.916, Zhongzheng Rd.,
Zhonghe District,
New Taipei City, 23586, Taiwan, R.O.C.
Tel: +886-2-8226-7786
Fax: +886-2-8226-7926
Email: jennyshern@nexcobot.com
www.nexcobot.com

GreenBase Technology Corp.

13F, No.922, Zhongzheng Rd.,
Zhonghe District,
New Taipei City, 23586, Taiwan, R.O.C.
Tel: +886-2-8226-7786
Fax: +886-2-8226-7900
Email: vivianlin@nexcom.com.tw
www.nexcom.com.tw

DivioTec Inc.

19F-1A, No.97, Sec.4, ChongXin Rd.,
Sanhong District,
New Taipei City, 24161, Taiwan, R.O.C.
Tel: +886-2-8976-3077
Email: sales@diviotec.com
www.diviotec.com

AIoT Cloud Corp.

13F, No.922, Zhongzheng Rd.,
Zhonghe District,
New Taipei City, 23586, Taiwan, R.O.C.
Tel: +886-2-8226-7786
Fax: +886-2-8226-7782
Email: alantsai@aiotcloud.net
www.aiotcloud.dev

EMBUX TECHNOLOGY CO., LTD.

13F, No.916, Zhongzheng Rd.,
Zhonghe District,
New Taipei City, 23586, Taiwan, R.O.C.
Tel: +886-2-8226-7786
Fax: +886-2-8226-7782
Email: info@embux.com
www.embux.com

TMR TECHNOLOGIES CO., LTD.

13F, No.916, Zhongzheng Rd.,
Zhonghe District,
New Taipei City, 23586, Taiwan, R.O.C.
Tel: +886-2-8226-7786
Fax: +886-2-8226-7782
Email: services@tmrtek.com
www.tmrtek.com

China NEXSEC Incorporated

201, Floor 2, Unit 2, Building 15, Yard 3,
Gaolizhang Road, Haidian District,
Beijing, 100094, China
Tel: +86-10-5704-2680
Fax: +86-10-5704-2681
Email: marketing@nexsec.cn
www.nexsec.cn

NEXCOM Shanghai

Room 406-407, Building C, No 154, Lane 953,
Jianchuan Road, Minhang District,
Shanghai, 201108, China
Tel: +86-21-5278-5868
Fax: +86-21-3251-6358
Email: sales@nexcom.cn
www.nexcom.cn

NEXCOM Surveillance Technology Corp.

Floor 8, Building B3, Xiufeng Industrial Zone,
GanKeng Community, Buji Street,
LongGang District,
ShenZhen, 518112, China
Tel: +86-755-8364-7768
Fax: +86-755-8364-7738
Email: steveyang@nexcom.com.tw
www.nexcom.cn

NEXGOL Chongqing

1st Building No.999,
Star Boulevard, Yongchuan Dist,
Chongqing City, 402160, China
Tel: +86-23-4960-9080
Fax: +86-23-4966-5855
Email: sales@nexgol.com.cn
www.nexcom.cn

Beijing NexGemo Technology Co.,Ltd.

Room 205, No.1, Fazhan Rd.,
Beijing International Information Industry Base,
Changping District,
Beijing, 102206, China
Tel: +86-10-8072-2025
Fax: +86-10-8072-2022
Email: sales@nexgemo.cn
www.nexgemo.com

Japan

NEXCOM Japan

9F, Tamachi Hara Bldg.,
4-11-5, Shiba Minato-ku,
Tokyo, 108-0014, Japan
Tel: +81-3-5419-7830
Fax: +81-3-5419-7832
Email: sales@nexcom-jp.com
www.nexcom-jp.com

America

USA NEXCOM USA

46665 Fremont Blvd.,
Fremont CA 94538, USA
Tel: +1-510-656-2248
Fax: +1-510-656-2158
Email: sales@nexcom.com
www.nexcomusa.com

Europe

United Kingdom NEXCOM EUROPE

10 Vincent Avenue,
Crownhill Business Centre,
Milton Keynes, Buckinghamshire
MK8 0AB, United Kingdom
Tel: +44-1908-267121
Fax: +44-1908-262042
Email: sales.uk@nexcom.eu
www.nexcom.com

Package Contents

Before continuing, verify that the FTA5180 series package that you received is complete. Your FTA5180 series package should have all the items listed in the table below.

Item	Part Number	Name	Qty
1	5040210036X00	EAR SET FOR NSA5181 VER: A PANADVANCE 53.85x43x22mm SECC T=2.0mm PANTING PANTONE 295U / EAR SETS	1
2	5044440031X00	Rubber Foot Kang Yang:RF20-5 4P 19.8x18x5.0mm	1
3	6023309081X00	Cable EDI:232091081804-RS COM Port. DB9 Female to RJ45 8P8C L:1800mm	1

CHAPTER 1: PRODUCT INTRODUCTION

Overview



Key Features

- Intel® Xeon® D-1734NT processor
- 4 x RDIMM/UDIMM socket, support ECC/non ECC, up to 256GB
- 2 x M.2 2242 Key M with SATA signal
- 6 x 10G SFP+ ports
- 2 x 10GBaseT RJ45 PoE++ port
- 2 x 2.5G RJ45 PoE++ ports
- 1 x LAN module slot
- Supports IPMI2.0
- Supports Intel® QAT
- TPM2.0 onboard

Hardware Specifications

Main Board

- Intel® Xeon® D-1734NT, SoC, BGA type, 8 cores, w/QAT
- TPM2.0 onboard
- Dual BIOS onboard

Main Memory

4 x DDR4 2666 RDIMM/UDIMM ECC/non ECC sockets, up to 256GB

Storage Device

- 2 x M.2 2242 Key M SATA SSD

Interface External

- Button: PWR/reset
- LED: PWR/SSD/SYS1/SYS2/PoE
- 8 x SMA connectors
- 2 x USB 3.0 ports
- 1 x RJ45 console port
- 1 x RJ45 management port
- 6 x 10G SFP+ ports
- 2 x 10GBaseT RJ45 PoE++ ports
- 2 x 2.5G RJ45 PoE++ ports
- 1 x VGA port
- 1 x LAN module slot
- 2 x AC power inlets
- 4 x Smart fans

Interface Internal

- 1 x M.2 3042 Key B slot for 5G module
- 1 x mini-PCIe slot for Wi-Fi module

Power

- 650W (1+1) redundant PSU

Dimension and Weight

- Chassis dimension (mm): 438 x 370 x 44 mm (W x D x H)

Environment

- Operating temperatures: 0°C-40°C
- Storage temperature: -20°C-80°C
- Relative humidity: 10%-90% non-condensing

Certifications

- CE/FCC Class A
- CE-LVD

Knowing Your FTA5180

Front Panel

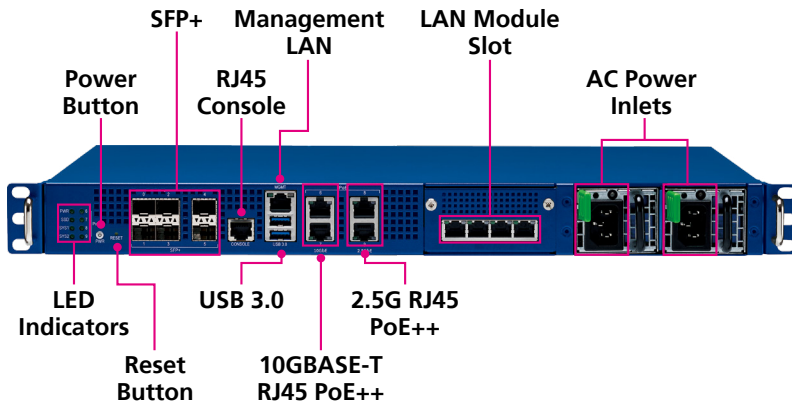

LAN LED Indicators

Indicates the data activity and link status of PWR/SSD/SYS1/SYS2/PoE ports.

Power Button

Press to power-on or power-off the system.

Reset Button

Press and hold this button for 4 seconds to restart the system.

10G SFP+ Ports

Used to connect SFP+ modules for connecting fiber optic network devices.

RJ45 Console Ports

Used to connect to devices with RJ45 type console connection.

Management LAN Port

Management LAN port used for managing the system.

USB 3.0 Port

Used to connect USB 3.0/2.0/1.1 devices.

10GBASE-T RJ45 PoE++

Used to connect the system to a local area network.

2.5G RJ45 PoE++

Used to connect the system to a local area network.

LAN Module Slot

LAN module bay to install add-on network modules.

AC Power Inlets

Used to plug an AC power cord to power the system.

Rear Panel

VGA

Used to connect an analog VGA monitor.

SMA Connectors

Used to plug coaxial cable and optical fibers.

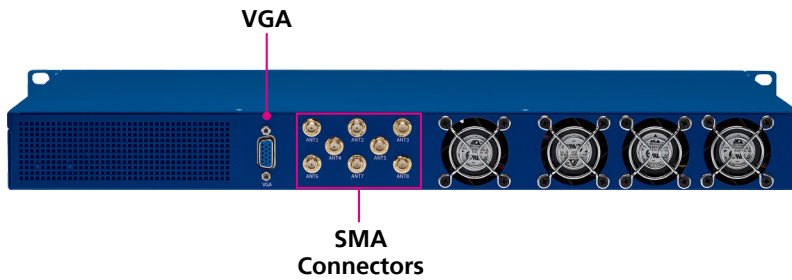

CHAPTER 2: JUMPERS AND CONNECTORS

This chapter describes how to set the jumpers and connectors on the FTA5180 motherboard.

Before You Begin

- Ensure you have a stable, clean working environment. Dust and dirt can get into components and cause a malfunction. Use containers to keep small components separated.
- Adequate lighting and proper tools can prevent you from accidentally damaging the internal components. Most of the procedures that follow require only a few simple tools, including the following:
 - A Philips screwdriver
 - A flat-tipped screwdriver
 - A set of jewelers screwdrivers
 - A grounding strap
 - An anti-static pad
- Using your fingers can disconnect most of the connections. It is recommended that you do not use needle-nosed pliers to disconnect connections as these can damage the soft metal or plastic parts of the connectors.
- Before working on internal components, make sure that the power is off. Ground yourself before touching any internal components, by touching a metal object. Static electricity can damage many of the electronic components. Humid environments tend to have less static electricity than

dry environments. A grounding strap is warranted whenever danger of static electricity exists.

Precautions

Computer components and electronic circuit boards can be damaged by discharges of static electricity. Working on computers that are still connected to a power supply can be extremely dangerous.

Follow the guidelines below to avoid damage to your computer or yourself:

- Always disconnect the unit from the power outlet whenever you are working inside the case.
- If possible, wear a grounded wrist strap when you are working inside the computer case. Alternatively, discharge any static electricity by touching the bare metal chassis of the unit case, or the bare metal body of any other grounded appliance.
- Hold electronic circuit boards by the edges only. Do not touch the components on the board unless it is necessary to do so. Don't flex or stress the circuit board.
- Leave all components inside the static-proof packaging that they shipped with until they are ready for installation.
- Use correct screws and do not over tighten screws.

Jumper Settings

A jumper is the simplest kind of electric switch. It consists of two metal pins and a cap. When setting the jumpers, ensure that the jumper caps are placed on the correct pins. When the jumper cap is placed on both pins, the jumper is short. If you remove the jumper cap, or place the jumper cap on just one pin, the jumper is open.

Refer to the illustrations below for examples of what the 2-pin and 3-pin jumpers look like when they are short (on) and open (off).

Two-Pin Jumpers: Open (Left) and Short (Right)

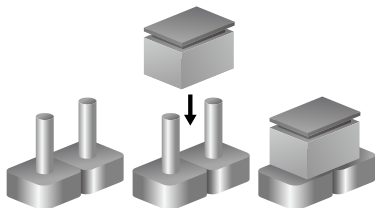

Three-Pin Jumpers: Pins 1 and 2 are Short

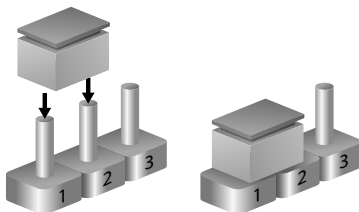

Locations of the Jumpers and Connectors

The figure below shows the location of the jumpers and connectors.

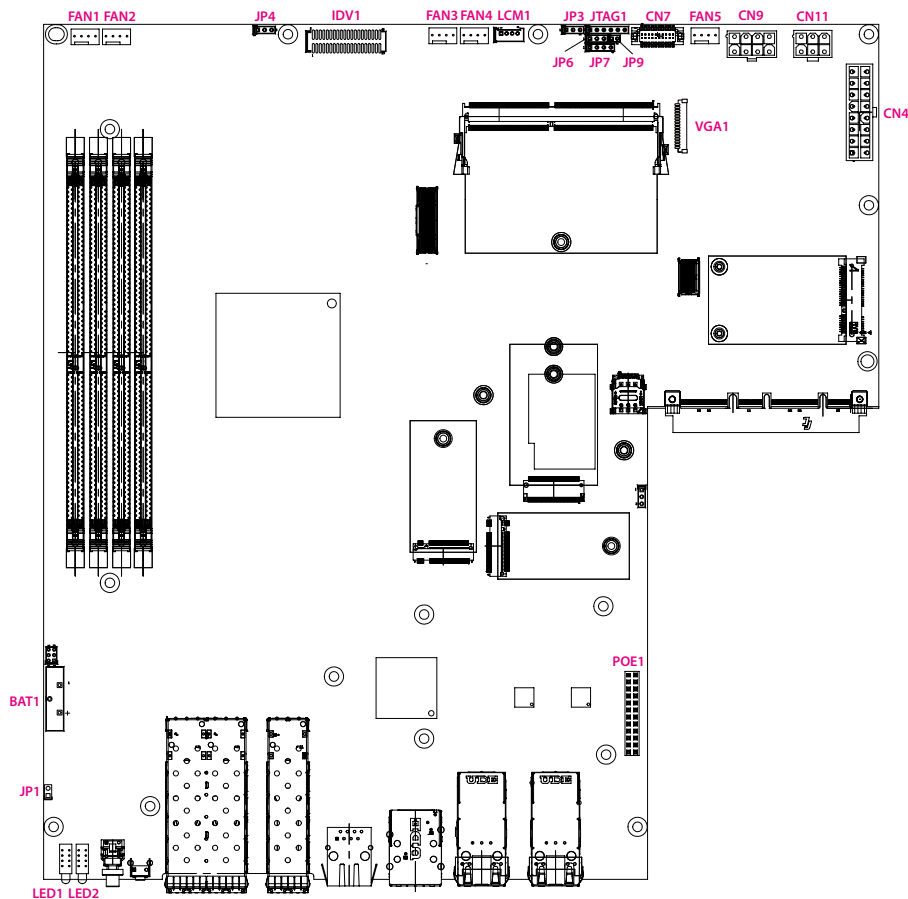

Jumpers

RTC Clear

Connector type: 1x3 3-pin header

Connector location: JP3

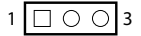

Pin	Function
1-2	Normal
2-3	Clear CMOS

Connector Pin Definitions

External I/O Interfaces

Power LED

Connector location: LED1



Pin	Definition	Pin	Definition
1	CPLD_PWR_LED	2	CPLD_HDD_LED
3	SW_SYS_LED	4	CPLD_GPIO1_LED

PoE LED

Connector location: LED2



Pin	Definition	Pin	Definition
1	POE_LED1	2	POE_LED2
3	POE_LED3	4	POE_LED4

Internal Connectors

PoE Header

Connector type: 2x12 24-pin header

Connector location: POE1

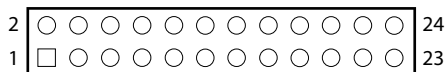

Pin	Definition	Pin	Definition
1	POE_LED1	2	POE_LED2
3	POE_LED3	4	POE_LED4
5	GND	6	P3V3
7	SMB_DAT_POE_R	8	POE_INT_N
9	SMB_CLK_POE_R	10	POE_RST_N
11	GND	12	NC
13	POE MAIN POK	14	VPORT_NEG_10G_OUT4
15	P54V	16	VPORT_NEG_10G_OUT3
17	P54V	18	VPORT_NEG_10G_OUT2
19	P54V	20	VPORT_NEG_10G_OUT1
21	VPORT_NEG_10G_OUT8	22	VPORT_NEG_10G_OUT5
23	VPORT_NEG_10G_OUT7	24	VPORT_NEG_10G_OUT6

PWM Controller SMBUS Header

Connector type: 1x3 3-pin header

Connector location: JP4

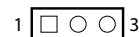

Pin	Function
1	SMB_DATA
2	SMB_CLK
3	GND

LCM (Reserved)

Connector type: 1x4 4-pin header

Connector location: LCM1

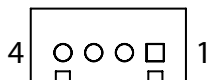

Pin	Definition	Pin	Definition
1	PWR_LCM	2	SP_LCM_TXD
3	SP_LCM_RXD	4	GND

Fan Wafer Connector

Connector type: 1x4 4-pin header

Connector location: FAN1, FAN2, FAN3, FAN4, FAN5

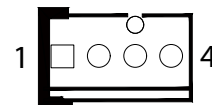

Pin	Definition	Pin	Definition
1	GND	2	P12V
3	TACH	4	PWM

Internal Power Connector

Connector type: 2x8 16-pin header
 Connector location: CON4

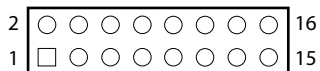

Pin	Definition	Pin	Definition
1	P12V_AUX	2	P12V_AUX
3	P12V_AUX	4	P12V_AUX
5	P12V_AUX	6	P12V_AUX
7	P12V_AUX	8	P5V_STBY
9	GND	10	GND
11	GND	12	GND
13	GND	14	GND
15	GND	16	GND

Internal Power Connector

Connector type: 2x4 8-pin header
 Connector location: CN9

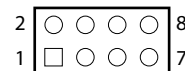

Pin	Definition	Pin	Definition
1	GND	2	GND
3	GND	4	GND
5	P12V	6	P12V
7	P12V	8	P12V

Internal Power Connector

Connector type: 2x3 6-pin header

Connector location: CN11

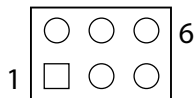

Pin	Definition	Pin	Definition
1	GND	2	GND
3	GND	4	P12V
5	P12V	6	P12V

Power signal to power supply

Connector type: 2x10 20-pin header

Connector location: CN7

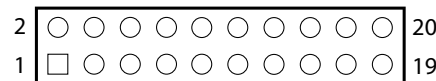

Pin	Definition	Pin	Definition
1	NC	2	SMB-ALERT_A_CAB
3	NC	4	SMB-ALERT_B_CAB
5	SMB_PMBUS1_STBY_LVC3_R_SCL	6	PRESENT_IN_A_CAB
7	SMB_PMBUS1_STBY_LVC3_R_SDA	8	PRESENT_IN_B_CAB
9	NC	10	GND
11	PS_ON_R	12	P3V3_AUX
13	NC	14	P3V3_AUX
15	PW_OK_A_CAB	16	GND
17	PW_OK_B_CAB	18	NC
19	NC	20	NC

SYS RTC Holder

Connector type: 1x3 3-pin header

Connector location: BAT1

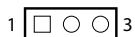

Pin	Function
1	RTC_BAT
2	RTC_BAT
3	GND

UART from CPLD (Reserved)

Connector type: 1x3 3-pin header

Connector location: JP6



Pin	Function
1	PLD_PR20C
2	GND
3	PLD_PR20D

JTAG header from CPLD or BMC select

Connector type: 1x2 2-pin header

Connector location: JP9



Pin	Function
1	JTAG_SEL
2	GND

BMC UART Debug

Connector type: 1x4 4-pin header

Connector location: JP7

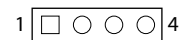

Pin	Definition	Pin	Definition
1	P3V3_BMC	2	BMC_CPLD_DEBUG_RXD
3	BMC_CPLD_DEBUG_TXD	4	GND

IDV connector (For Debug)

Connector type: 2x20 40-pin header

Connector location: IDV1

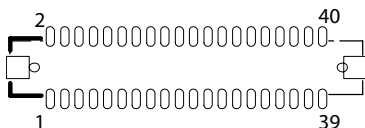

Pin	Definition	Pin	Definition
1	P3V3_RTC_AUX	2	PWRGD_P3V3_AUX
3	RST_RTCRST_N	4	PWRGD_CPU_LVC3_PLD_R3
5	P3V3_SOC	6	GND
7	P1V8_AUX	8	P1V05
9	PVNN_NAC	10	IDV_RST_PLTRST_N
11	P1V05_NAC	12	PVNN_PCH
13	RST_RSMRST_PCH_N	14	PWRGD_PVCCIN_CPU
15	FM_CPU_MSMT_LVT3_R_N	16	GND
17	P1V2_VDDQ	18	PWRGD_PCH_PWROK
19	NC	20	PVCCIN_CPU
21	PWRGD_PVNN_NAC	22	P2V5_PVPP
23	NC	24	FM_CPU_ERR2_LVT3_N
25	FM_CPU_CATERR_LVT3_R_N	26	GND
27	FM_CPU_PROCHOT_LATCH_LVT3_R_N	28	FM_CPU_ERR1_LVT3_N
29	FM_CPU_THERMTRIP_LATCH_LVT3_R_N	30	FM_CPU_ERR0_LVT3_N
31	PWRGD_DRAMPWRGD_R2	32	PVTT
33	PWRGD_PS_PWROK_IDV	34	FM_SLPS3_N
35	FM_SLPS4_N	36	GND
37	SMB_SMLINK0_STBY_LVC3_MITL_SDA	38	SMB_SMLINK0_STBY_LVC3_SCL
39	PECI_CPU_PCH_BMC_R1	40	IDV_PWR_BUTTON_N

System Power Button Header

Connector type: 1x2 2-pin header

Connector location: JP1

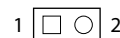

Pin	Definition
1	IDV_PWR_BUTTON_N
2	GND

CPLD JTAG

Connector type: 1x6 6-pin header

Connector location: JTAG1

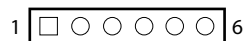

Pin	Definition	Pin	Definition
1	P3V3_CPLD	2	GND
3	JTAG_TCK_CPLD	4	JTAG_TDO_CPLD
5	JTAG_TDI_CPLD	6	JTAG_TMS_CPLD

VGA

Connector type: 1x16 16-pin header

Connector location: VGA1



Pin	Definition	Pin	Definition
1	VGA_VCC	2	GND
3	NC	4	SMB_BMC_DDC_SCL_R1
5	SMB_BMC_DDC_SDA_R1	6	NC
7	V_BMC_GFX_REAR_VSYN_R3	8	GND
9	V_BMC_GFX_REAR_HSYN_R3	10	NC
11	GND	12	V_BMC_GFX_REAR_BLU_R1
13	GND	14	V_BMC_GFX_REAR_GRN_R1
15	GND	16	V_BMC_GFX_REAR_RED_R1

XDP Connector (For Debug)

Connector size: 2x30 60-pin header

Connector location: XDP1

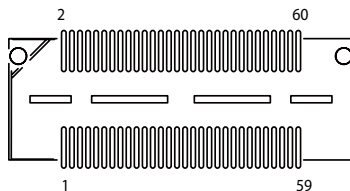

Pin	Definition	Pin	Definition
1	P1V05	2	XDP_SOC_TMS
3	XDP_CPU_TCK0	4	XDP_SOC_TDO
5	XDP_SOC_TDI	6	XDP_RST_BTN_N
7	XDP_RST_PLTRST_N	8	TRST_PD
9	XDP_TRST_N	10	XDP_PREQ_N
11	XDP_PRDY_N	12	P1V05
13	TRC_PTI_CLK0	14	GND
15	FM_GBE_SDP_TIMESYNC3_R	16	GND
17	FM_DEBUG_EN_LVC3_N	18	TP_PCH_DBG_PTI_D0
19	TRC_DFX_D0	20	TP_PCH_DBG_PTI_D1
21	TRC_DFX_D1	22	TP_PCH_DBG_PTI_D2
23	TRC_DFX_D2	24	TP_PCH_DBG_PTI_D3
25	TRC_DFX_D3	26	TP_PCH_DBG_PTI_D4
27	TRC_DFX_D4	28	TP_PCH_DBG_PTI_D5
29	TRC_DFX_D5	30	TP_PCH_DBG_PTI_D6
31	TRC_DFX_D6	32	TP_PCH_DBG_PTI_D7
33	TRC_DFX_D7	34	TP_RSVD1_LTB_CONN
35	TRC_DFX_D8	36	FM_GBE_SDP_TIMESYNC2_R
37	TRC_DFX_D9	38	DBP_CPU_FBRK_N
39	TRC_DFX_D10	40	XDP_PWR_BTN_N

Pin	Definition	Pin	Definition
41	TRC_DFX_D11	42	XDP_RSMRST_N
43	TRC_DFX_D12	44	TP_RSVD2_LTB_CONN
45	TRC_DFX_D13	46	TP_RSVD3_LTB_CONN
47	TRC_DFX_D14	48	SMB_HOST_STBY_LVC3_XDP_SCL
49	TRC_DFX_D15	50	SMB_HOST_STBY_LVC3_XDP_SDA
51	XDP_SOC_TCK1	52	P3V3_SOC
53	XDP_SOC_MBP1	54	TP_XDP_UART_TX
55	XDP_SOC_MBP0	56	TP_XDP_UART_RX
57	GND	58	GND
59	TRC_PTI_CLK1	60	GND

Block Diagram

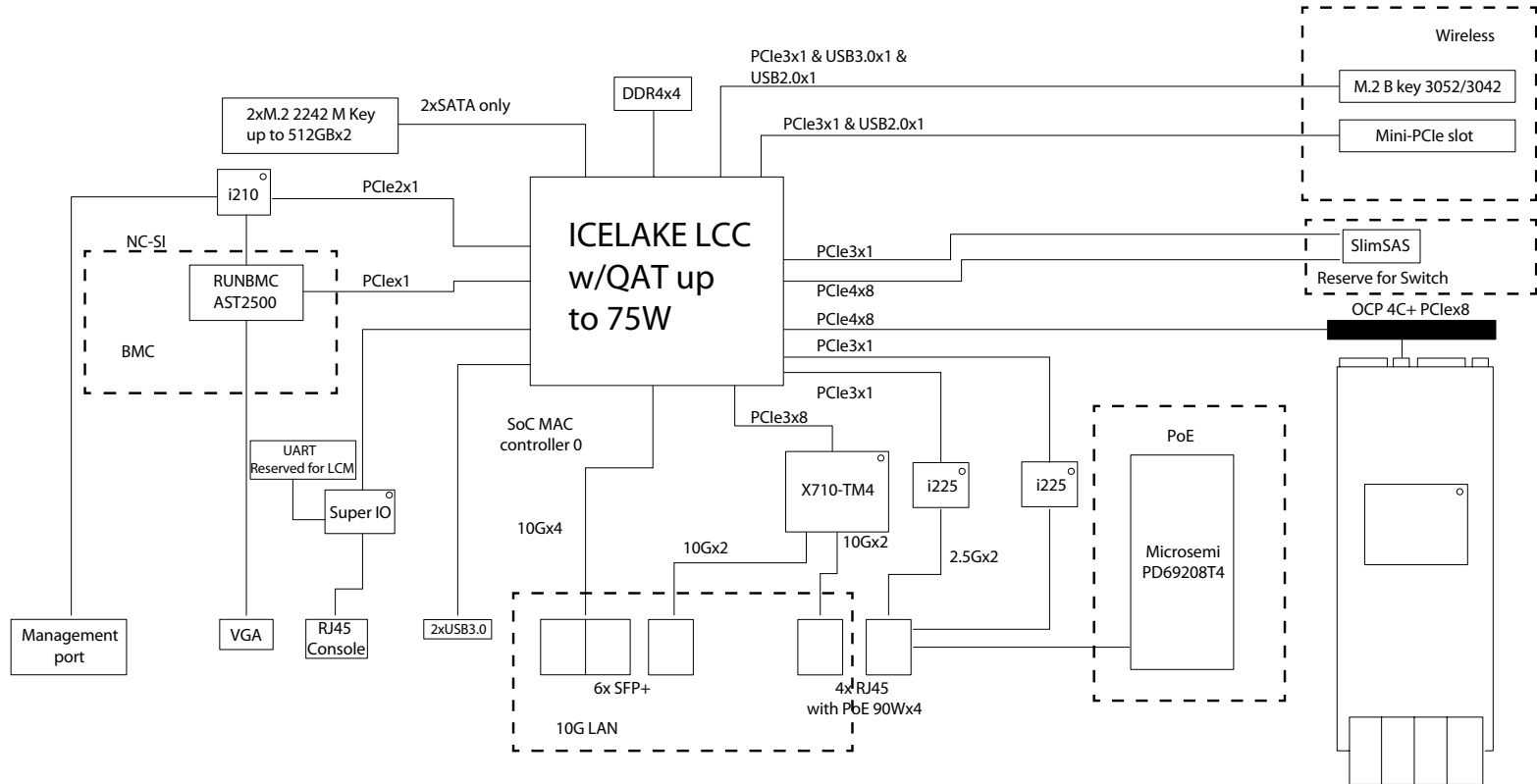

CHAPTER 3: BIOS SETUP

This chapter describes how to use the BIOS setup program for the FTA5180 series. The BIOS screens provided in this chapter are for reference only and may change if the BIOS is updated in the future.

To check for the latest updates and revisions, visit the NEXCOM website at www.nexcom.com.tw.

About BIOS Setup

The BIOS (Basic Input and Output System) Setup program is a menu driven utility that enables you to make changes to the system configuration and tailor your system to suit your individual work needs. It is a ROM-based configuration utility that displays the system's configuration status and provides you with a tool to set system parameters.

These parameters are stored in non-volatile battery-backed-up CMOS RAM that saves this information even when the power is turned off. When the system is turned back on, the system is configured with the values found in CMOS.

With easy-to-use pull down menus, you can configure items such as:

- Hard drives, diskette drives, and peripherals
- Video display type and display options
- Password protection from unauthorized use
- Power management features

The settings made in the setup program affect how the computer performs. It is important, therefore, first to try to understand all the setup options, and second, to make settings appropriate for the way you use the computer.

When to Configure the BIOS

- This program should be executed under the following conditions:
 - When changing the system configuration
 - When a configuration error is detected by the system and you are prompted to make changes to the setup program
 - When resetting the system clock
 - When redefining the communication ports to prevent any conflicts
 - When making changes to the Power Management configuration
 - When changing the password or making other changes to the security setup

Normally, CMOS setup is needed when the system hardware is not consistent with the information contained in the CMOS RAM, whenever the CMOS RAM has lost power, or the system features need to be changed.

Default Configuration

Most of the configuration settings are either predefined according to the Load Optimal Defaults settings which are stored in the BIOS or are automatically detected and configured without requiring any actions. There are a few settings that you may need to change depending on your system configuration.











Entering Setup

When the system is powered on, the BIOS will enter the Power-On Self Test (POST) routines. These routines perform various diagnostic checks; if an error is encountered, the error will be reported in one of two different ways:

- If the error occurs before the display device is initialized, a series of beeps will be transmitted.
- If the error occurs after the display device is initialized, the screen will display the error message.

Powering on the computer and immediately pressing  allows you to enter Setup.

Legends

Key	Function
	Moves the highlight left or right to select a menu.
	Moves the highlight up or down between sub-menu or fields.
	Exits the BIOS Setup Utility.
	Scrolls forward through the values or options of the highlighted field.
	Scrolls backward through the values or options of the highlighted field.
	Selects a field.
	Displays General Help.
	Load previous values.
	Load optimized default values.
	Saves and exits the Setup program.
	Press <Enter> to enter the highlighted sub-menu

Scroll Bar

When a scroll bar appears to the right of the setup screen, it indicates that there are more available fields not shown on the screen. Use the up and down arrow keys to scroll through all the available fields.

Submenu

When “▶” appears on the left of a particular field, it indicates that a submenu which contains additional options are available for that field. To display the submenu, move the highlight to that field and press  .

BIOS Setup Utility

Once you enter the AMI BIOS Setup Utility, the Main Menu will appear on the screen. The main menu allows you to select from several setup functions and one exit. Use arrow keys to select among the items and press  to accept or enter the submenu.

Main

The Main menu is the first screen that you will see when you enter the BIOS Setup Utility.

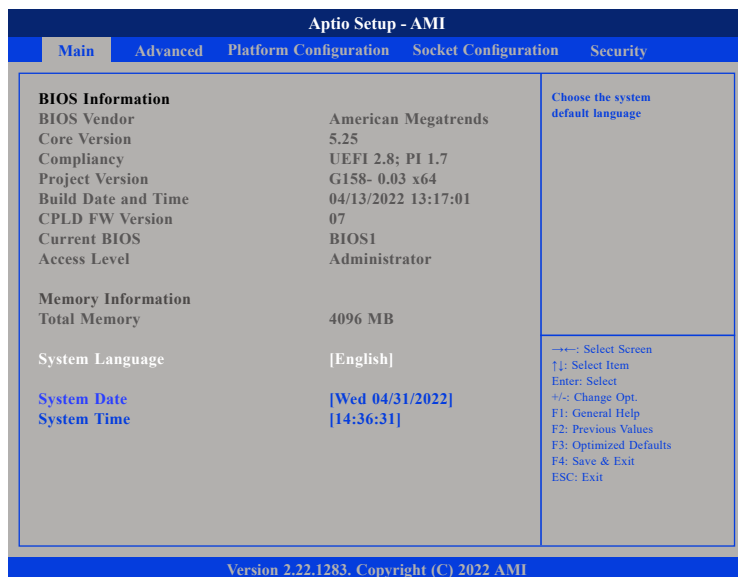

Access Level

Displays the access level of the current user in the BIOS.

System Date

The date format is <day>, <month>, <date>, <year>. Day displays a day, from Monday to Sunday. Month displays the month, from 1 to 12. Date displays the date, from 1 to 31. Year displays the year, from 2005 to 2099.

System Time

The time format is <hour>, <minute>, <second>. The time is based on the 24-hour military-time clock. For example, 1 p.m. is 13:00:00. Hour displays hours from 00 to 23. Minute displays minutes from 00 to 59. Second displays seconds from 00 to 59.

Advanced

The Advanced menu allows you to configure your system for basic operation. Some entries are defaults required by the system board, while others, if enabled, will improve the performance of your system or let you set some features according to your preference.



Setting incorrect field values may cause the system to malfunction.



Trusted Computing

This section is used to configure Trusted Platform Module (TPM) settings.

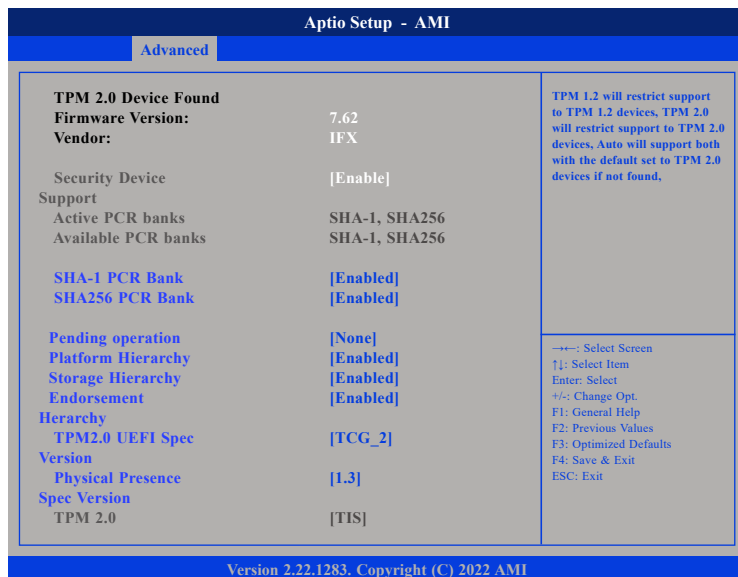

Security Device Support

Enables or disables BIOS support for security device. O.S will not show Security Device. TCG EFI protocol and INT1A interface will not be available.

SHA-1 PCR Bank

Enables or disables SHA-1 PCR Bank.

SHA256 PCR Bank

Enables or disables SHA256 PCR Bank

Pending operation

Schedules an operation for the security device.

Platform Hierarchy

Enables or disables Platform Hierarchy.

Storage Hierarchy

Enables or disables Storage Hierarchy.

Endorsement Hierarchy

Enables or disables Endorsement Hierarchy.

TPM2.0 UEFI Spec Version

Configures the TPM2.0 UEFI spec version.

Physical Presence Spec Version

Configures the physical presence spec version.

Device Select

TPM 1.2 will restrict support to TPM 1.2 devices. TPM 2.0 will restrict support to TPM 2.0 devices. Auto will support both TPM 1.2 and 2.0 devices with the default set to TPM 2.0 devices if not found, and TPM 1.2 devices will be enumerated.

NCT6683D Super IO Configuration

This section is used to configure the serial port of the super IO.

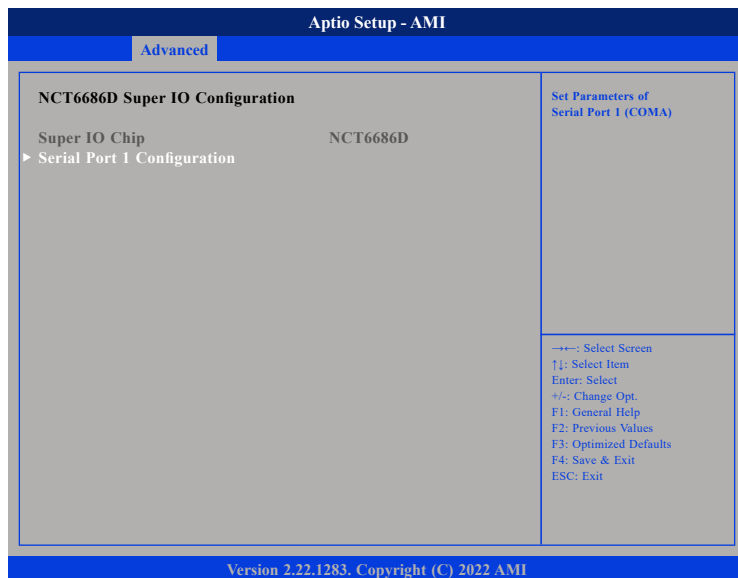

Super IO Chip

Displays the Super I/O chip used on the board.

Serial Port 1 Configuration

Configures the IO/IRQ settings of serial port 1.

Serial Port 1 Configuration

This section is used to configure serial port 1.

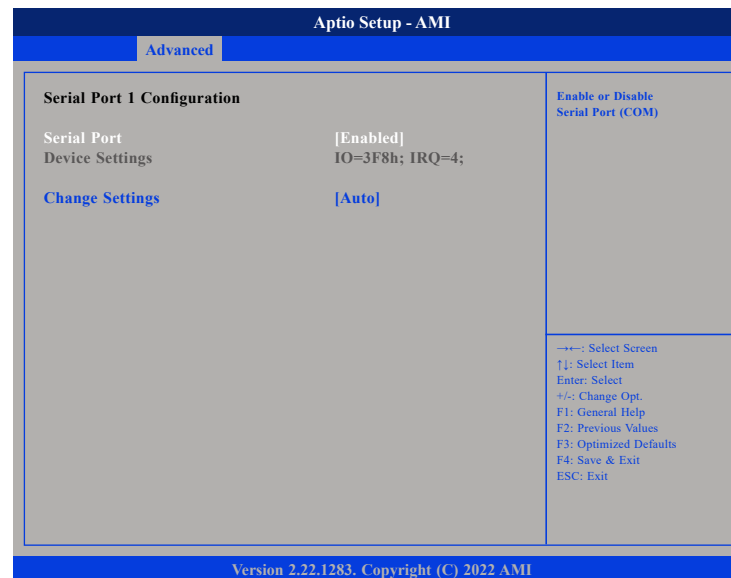

Serial Port

Enables or disables the serial port.

Change Settings

Selects an optimal setting for the Super IO device.

Hardware Monitor

This section is used to monitor hardware status such as temperature, fan speed and voltages.

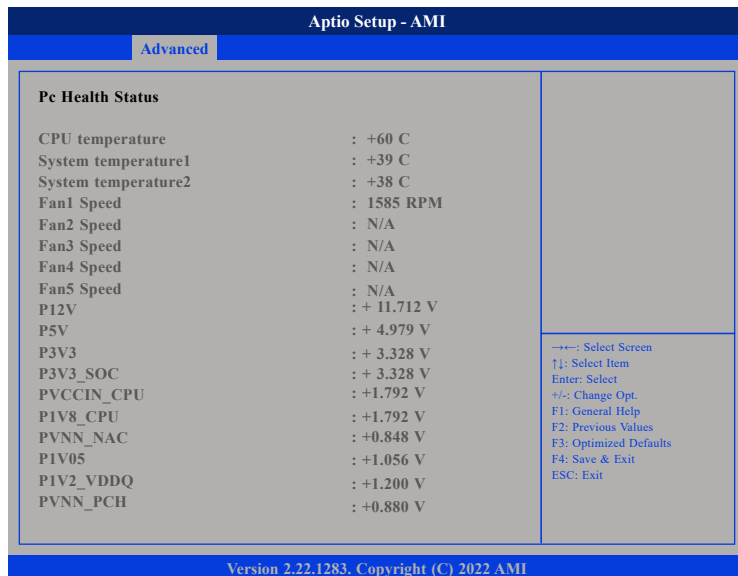

CPU and System Temperature

Detects and displays the current CPU and system temperature.

Fan1 to Fan5 Speed

Detects and displays the current fan1 to fan5 speed.

P12V to PVNN_PCH

Detects and displays the output voltages.

Serial Port Console Redirection

This section is used to configure the serial port that will be used for console redirection

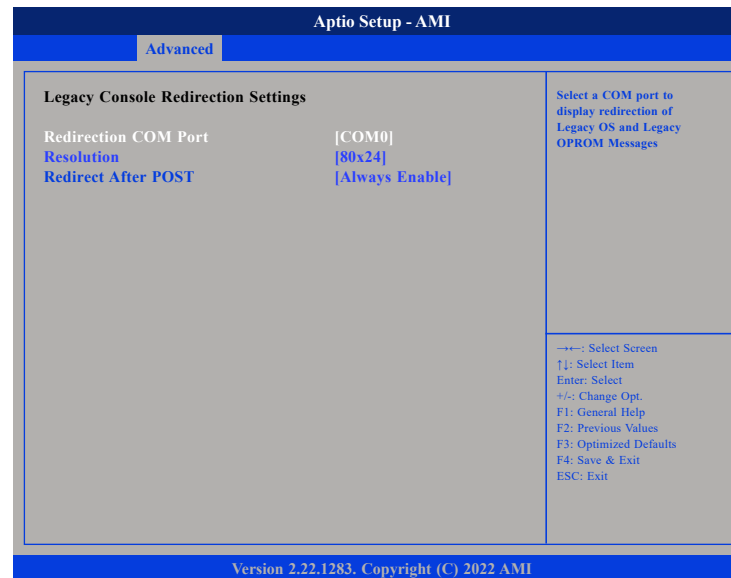

Redirection COM Port

Configures a COM port to display redirection of legacy OS and legacy OPROM messages.

Resolution

Configures the legacy OS redirection resolution.

Redirect After POST

Enables or disables redirection after POST.

Serial Port Console Redirection

This section is used to configure the serial port that will be used for console redirection.

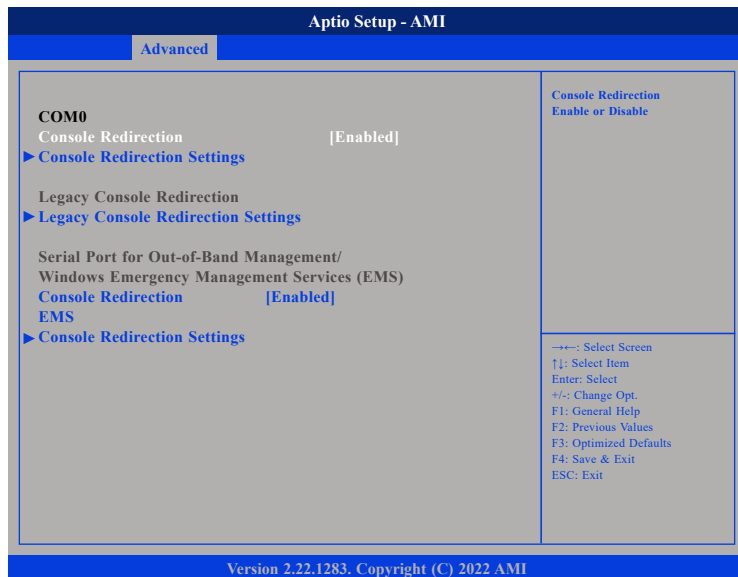

Console Redirection

Enables or disables the console redirection.

Console Redirection Settings

When console redirection is enabled, Console Redirection Settings will be available.

COM0 Console Redirection Settings

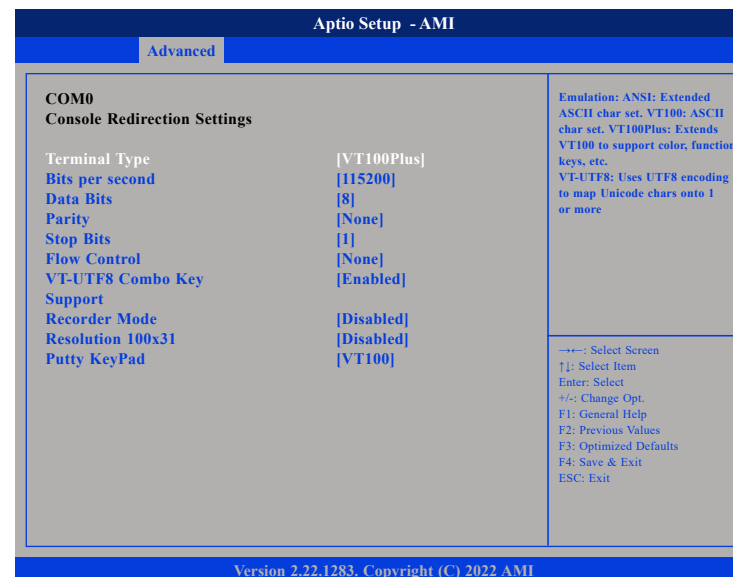

Terminal Type

ANSI Extended ASCII character set.

VT100 ASCII character set.

VT100+ Extends VT100 to support color, function keys, etc.

VT-UTF8 Uses UTF8 encoding to map Unicode characters onto 1 or more bytes.

Bits Per Second

Selects the serial port transmission speed. The speed must match the other side. Long or noisy lines may require a lower speed.

Data Bits

The options are 7 and 8.

Parity

A parity bit can be sent with the data bits to detect some transmission errors.

Even Parity bit is 0 if the number of 1's in the data bits is even.

Odd Parity bit is 0 if number of 1's in the data bits is odd.

Stop Bits

Stop bits indicate the end of a serial data packet. (A start bit indicates the beginning). The standard setting is 1 stop bit. Communication with slow devices may require more than 1 stop bit.

Flow Control

Flow control can prevent data loss from buffer overflow. When sending data and the receiving buffers are full, a "stop" signal can be sent to stop the data flow.

VT-UTF8 Combo Key Support

Enables or disables VT-UTF8 combo key support.

Recorder Mode

When this field is enabled, only text will be sent. This is to capture the terminal data.

Resolution 100x31

Enables or disables extended terminal resolution.

Putty Keypad

Selects the Putty keyboard emulation type.

PCI Subsystem Settings

This section is used to configure the PCI.

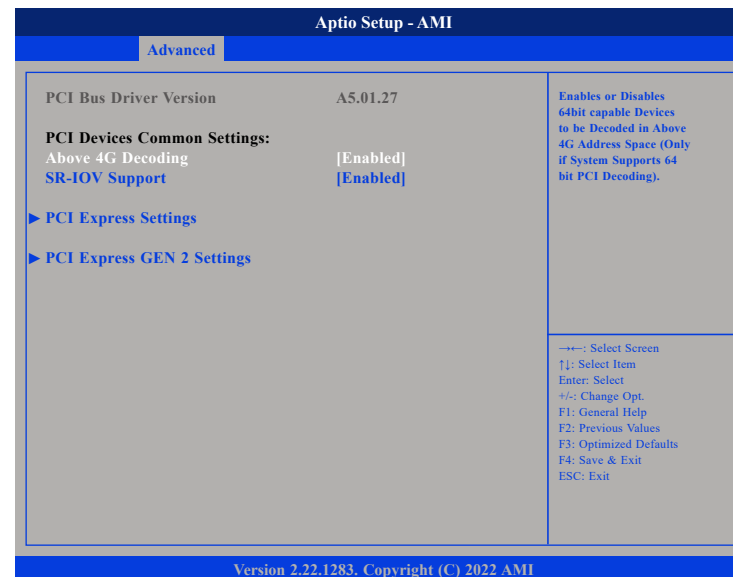

Above 4G Decoding

Enables or disables decoding of 64-bit devices in 4G address space.

SR-IOV Support

Enables or disables SR-IOV support

PCI Express Settings

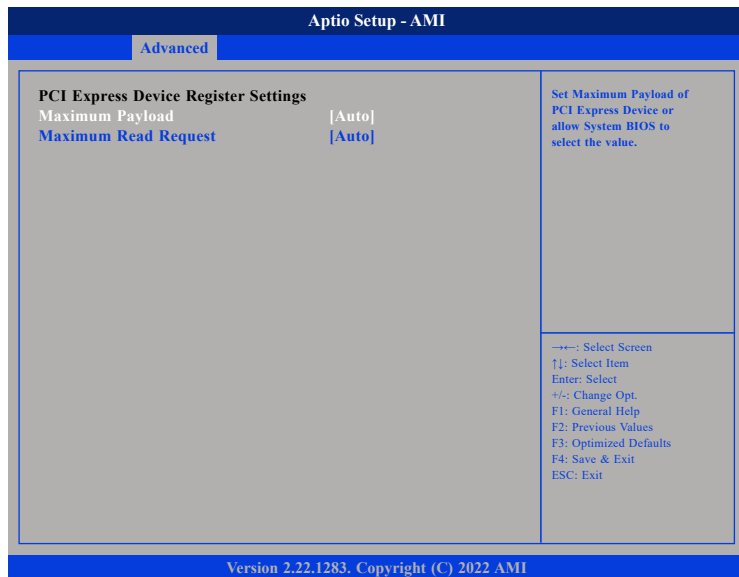

Maximum Payload

Selects the maximum TLP payload size of the PCI Express devices.

Maximum Read Request

Selects the maximum read request size of the PCI Express devices.

PCI Express GEN 2 Settings

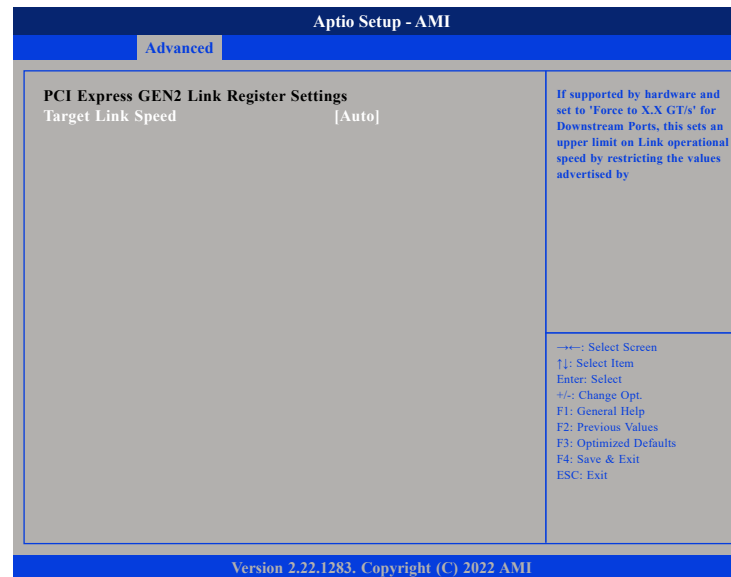

Target Link Speed

Configures the PCIe link speed.

USB Configuration

This section is used to configure the USB.

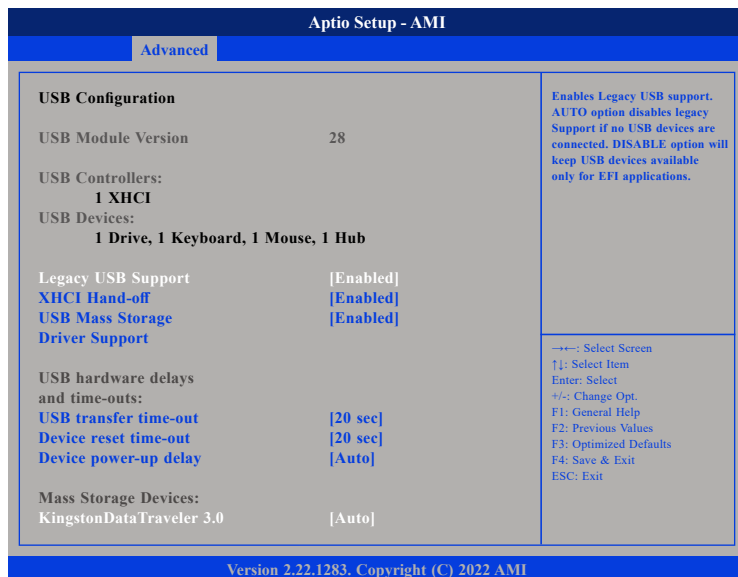

Legacy USB Support

Enable Enables Legacy USB.

Auto Disables support for Legacy when no USB devices are connected.

Disable Keeps USB devices available only for EFI applications.

XHCI Hand-off

This is a workaround for OSeS that does not support XHCI hand-off. The XHCI ownership change should be claimed by the XHCI driver.

USB Mass Storage Driver Support

Enables or disables USB mass storage driver support.

USB Transfer Time-out

The time-out value for control, bulk, and Interrupt transfers.

Device Reset Time-out

Selects the USB mass storage device's start unit command timeout.

Device Power-up Delay

Maximum time the value will take before it properly reports itself to the Host Controller. "Auto" uses default value: for a Root port it is 100 ms, for a Hub port the delay is taken from Hub descriptor.

Mass Storage Devices

Configures the mass storage device emulation type. AUTO enumerates devices according to their media format. Optical drives are emulated as CDROM, drives with no media will be emulated according to a drive type.

Network Stack Configuration

This section is used to configure the network stack.

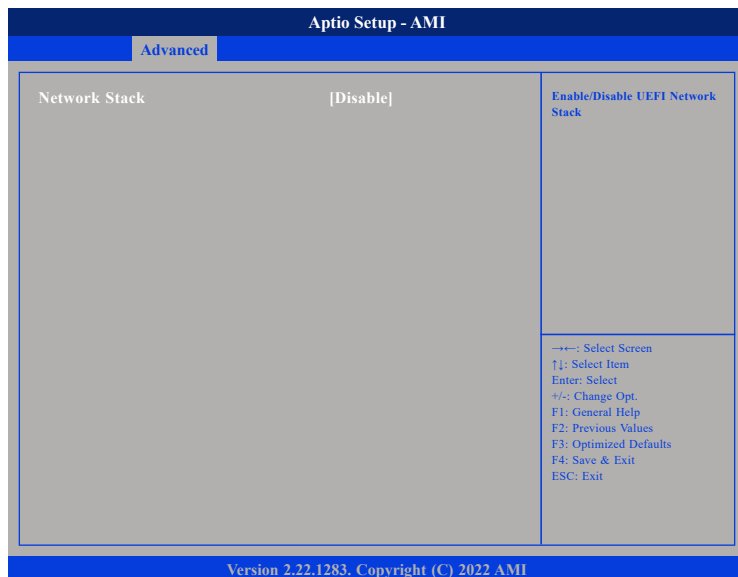

Network Stack

Enables or disables UEFI network stack.

CSM Configuration

This section is used to configure the compatibility support module features.

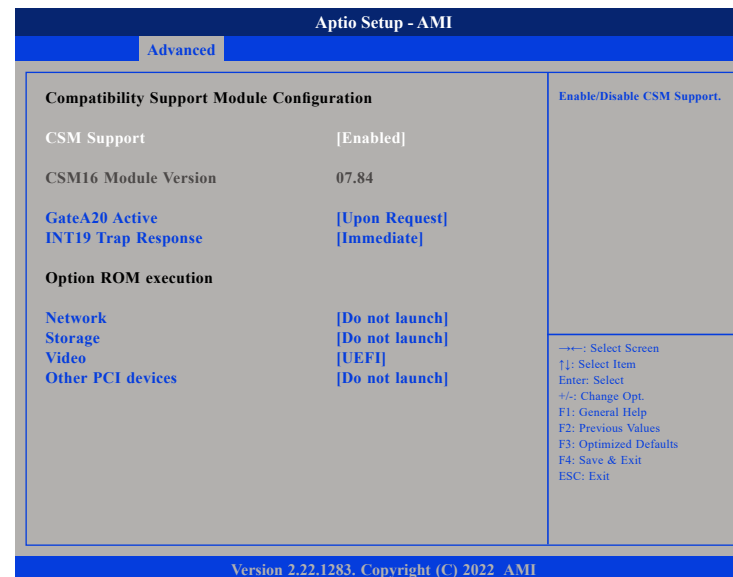

CSM Support

This field is used to enable or disable CSM support, if Auto option is selected, based on OS, CSM will be enabled or disabled automatically.

GateA20 Active

Upon Request GA20 can be disabled using BIOS services.
 Always Do not allow disabling of GA20; this option is useful when any RT code is executed above 1MB.

INT19 Trap Response

Allows Option ROMs to trap Interrupt 19 when enabled.

Immediate	Execute the trap right away.
Postponed	Execute the trap during legacy boot.

Network

Enables or disables the boot option for legacy network devices.

Storage

Enables or disables the boot option for legacy storage devices.

Video

Enables or disables the boot option for legacy video devices.

Other PCI Devices

Enables or disables the boot option for legacy PCI devices.

Platform Configuration

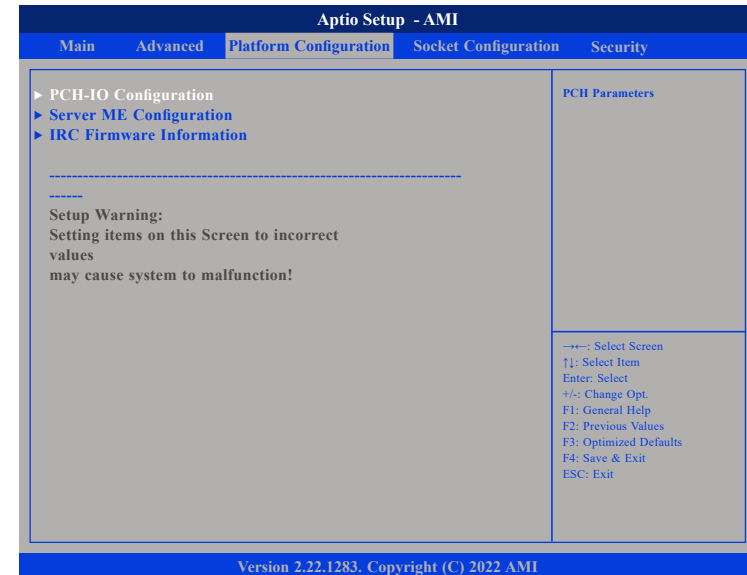

PCH-IO Configuration

PCH Parameters.

Server ME Configuration

Enters the Server ME Configuration submenu.

IRC Firmware Configuration

Enters the IRC Firmware Configuration submenu.

PCH-IO Configuration

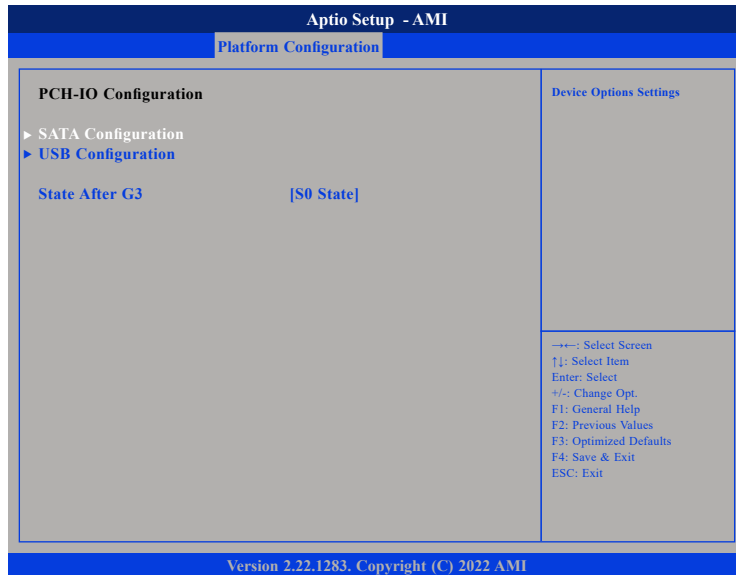

SATA Configuration

Device options settings.

USB Configuration

Enters the USB Configuration submenu.

State After G3

Configures the power state when power is re-applied after a power failure (G3 state).

Controller 3 SATA Configuration

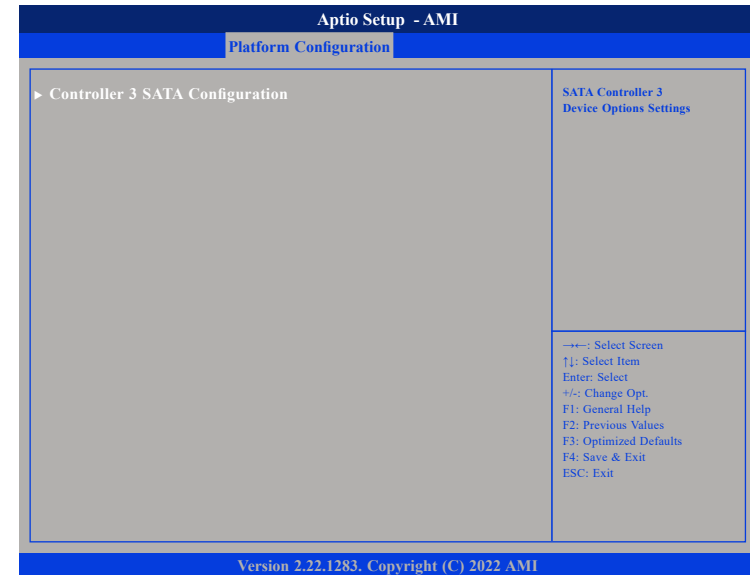

Controller 3 SATA Configuration

SATA Controller 3 device options settings.

Controller 3 SATA Configuration Cont.

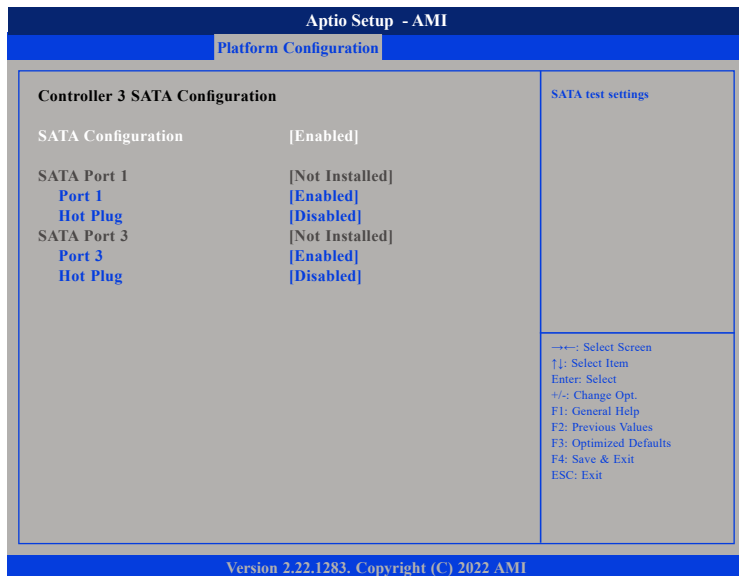

Port 1

Enables or disables Serial ATA port 1.

Port 3

Enables or disables Serial ATA port 3.

Hot Plug

Enables or disables hot plugging feature on Serial ATA port 1 or 3.

USB Configuration

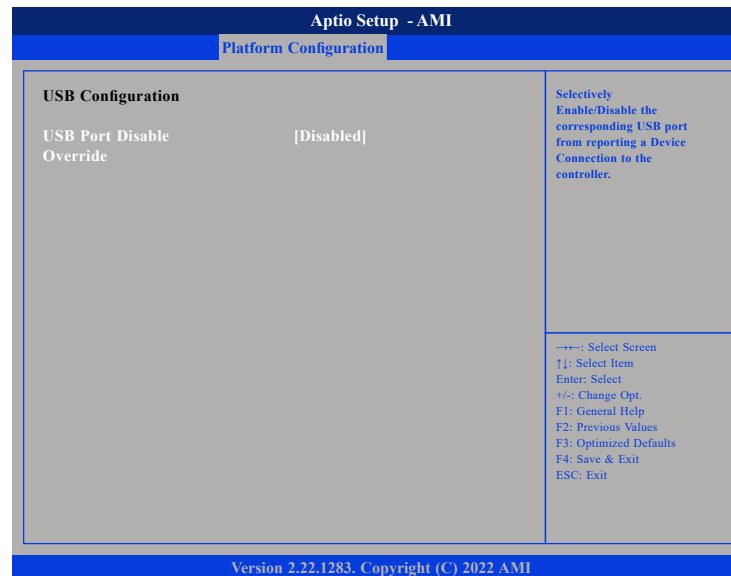

USB Port Disable Override

Enables or disables the USB port from reporting a device connection to the controller.

General ME Configuration

Aptio Setup - AMI	
Platform Configuration	
General ME Configuration	
Oper. Firmware Version	11:5.0.3.67
Backup Firmware Version	N/A
Recovery Firmware Version	11:5.0.3.67
ME Firmware Status #1	0x0000255
ME Firmware Status #2	0x88110006
Current State	Operational
Error Code	No Error
Recovery Cause	N/A
→←: Select Screen ↑↓: Select Item Enter: Select +/-: Change Opt. F1: General Help F2: Previous Values F3: Optimized Defaults F4: Save & Exit ESC: Exit	
Version 2.22.1283. Copyright (C) 2022 AMI	

iRC Firmware Information

Aptio Setup - AMI	
Platform Configuration	
Active Firmware Tag	000000 Official Release
Active Firmware Version	4.044
Active Firmware Type	1
Backup Firmware Tag	000000 Official Release
Backup Firmware Version	4.044
Backup Firmware Type	1
→←: Select Screen ↑↓: Select Item Enter: Select +/-: Change Opt. F1: General Help F2: Previous Values F3: Optimized Defaults F4: Save & Exit ESC: Exit	
Version 2.22.1283. Copyright (C) 2022 AMI	

Socket Configuration



Processor Configuration

Enters the Processor Configuration submenu.

Common RefCode Configuration

Enters the Common RefCode Configuration submenu.

Memory Configuration

Enters the Memory Configuration submenu.

IIO Configuration and Advanced Power Management Configuration

Enters the IIO Configuration and Advanced Power Management Configuration submenu.

Processor Configuration

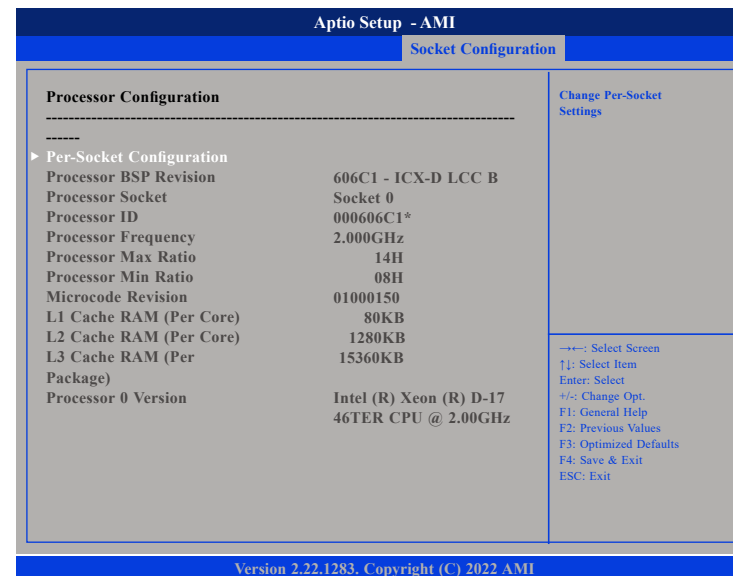

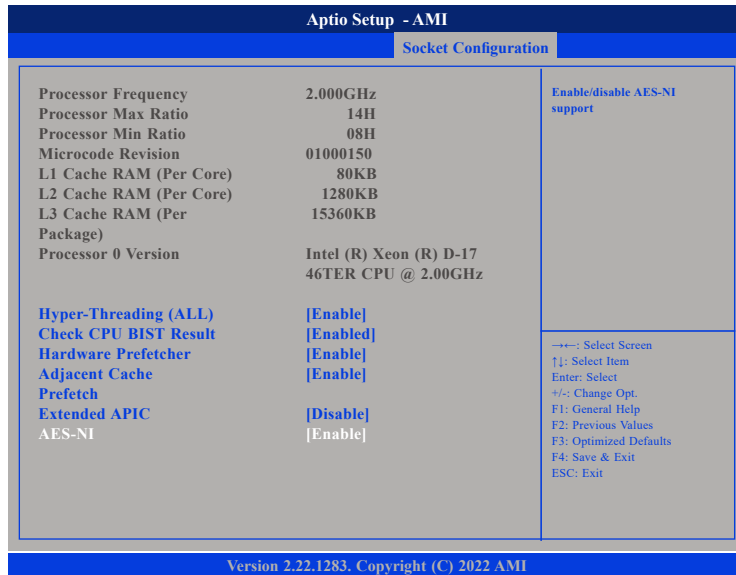

Extended APIC

Enables or disables extended APIC support.

AES-NI

Enables or disables AES-NI support.

Hyper-Threading [ALL]

Enables or disables hyper-threading technology.

Check CPU BIST Result

Enables or disables Check CPU BIST Result.

Hardware Prefetcher

Enables or disables the MLC streamer prefetcher.

Adjacent Cache Prefetcher

Enables or disables prefetching of adjacent cache lines.

Per-Socket Configuration

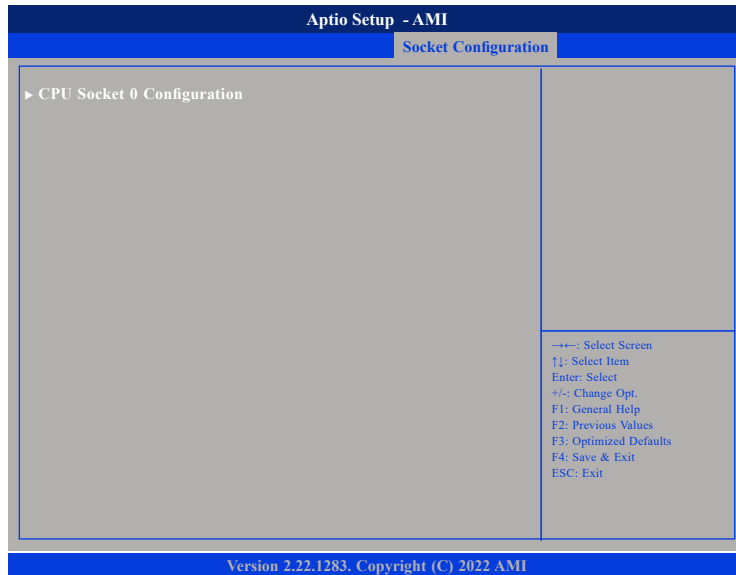

CPU Socket 0 Configuration

Processor settings for the CPU on socket 0.

CPU Socket 0 Configuration

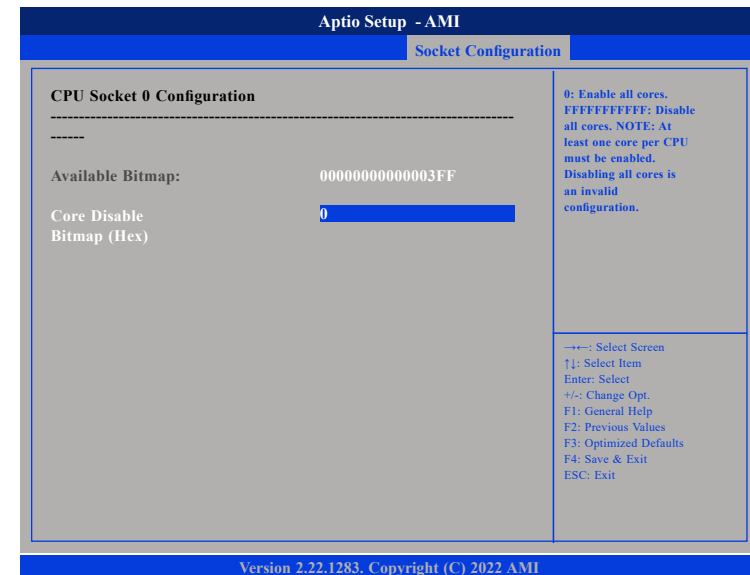

Cores Disable Bitmap

Provides the option to enable or disable all cores. 0 means enable all cores. FFFFFFFF means disable all cores.

Common RefCode Configuration

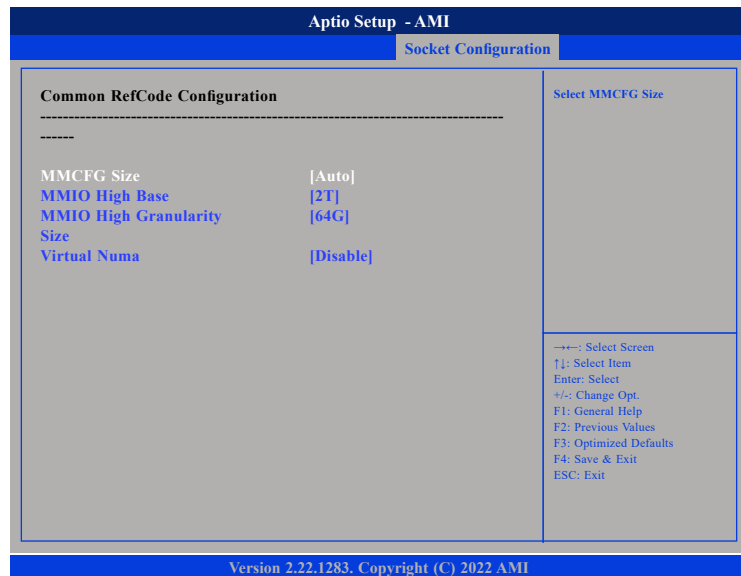

MMCFG Size

Select MMCFG size.

Virtual Numa

Enables or disables Non-Uniform Memory Access support.

Memory Configuration

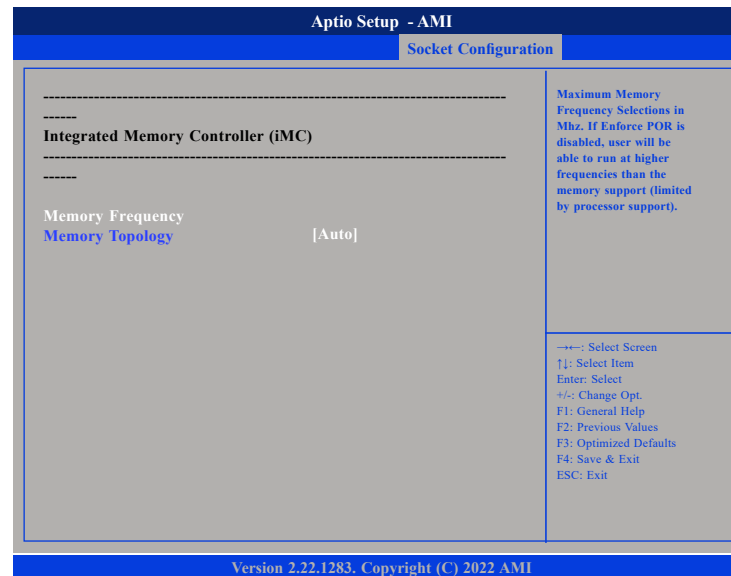

Memory Frequency

Configures the maximum frequency of the memory. Do not select Reserved.

Memory Topology

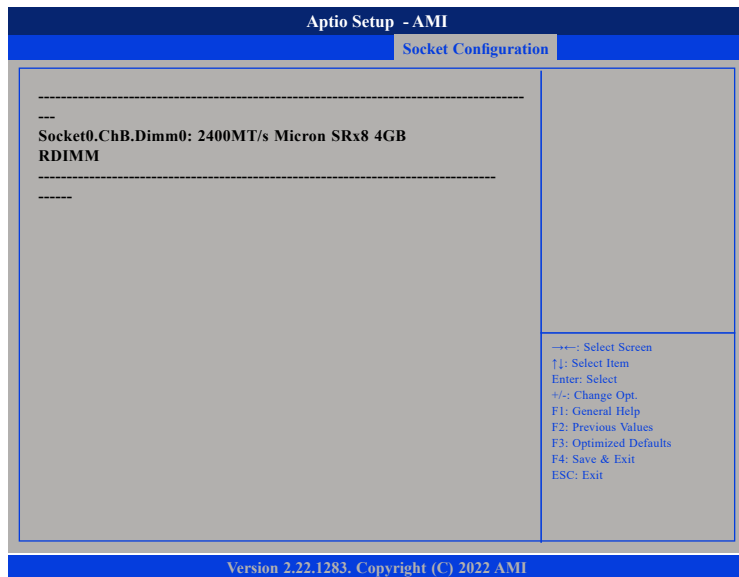

Detects and displays the information on the memory installed.

IIO Configuration

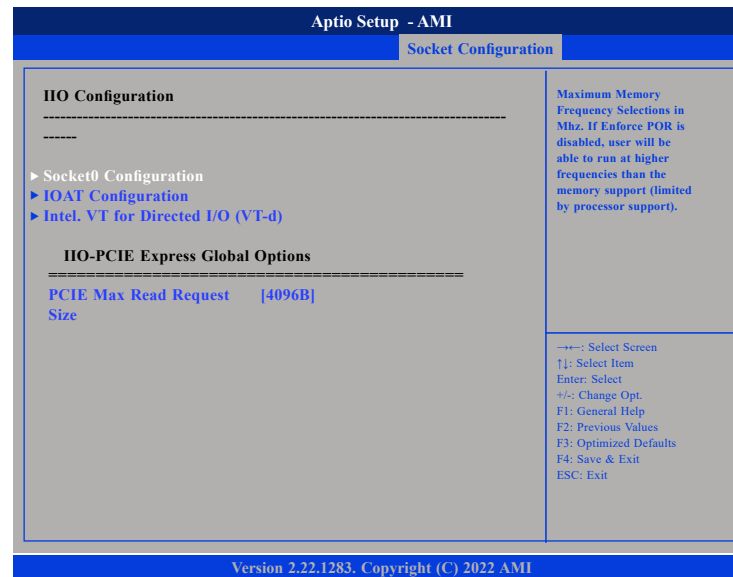

Socket0 Configuration

Enters the Socket0 Configuration submenu.

IOAT Configuration

Enters the IOAT Configuration submenu.

Intel. VT for Directed I/O (VT-d)

Enters the Intel® VT for Directed I/O (VT-d) submenu.

Socket0 Configuration

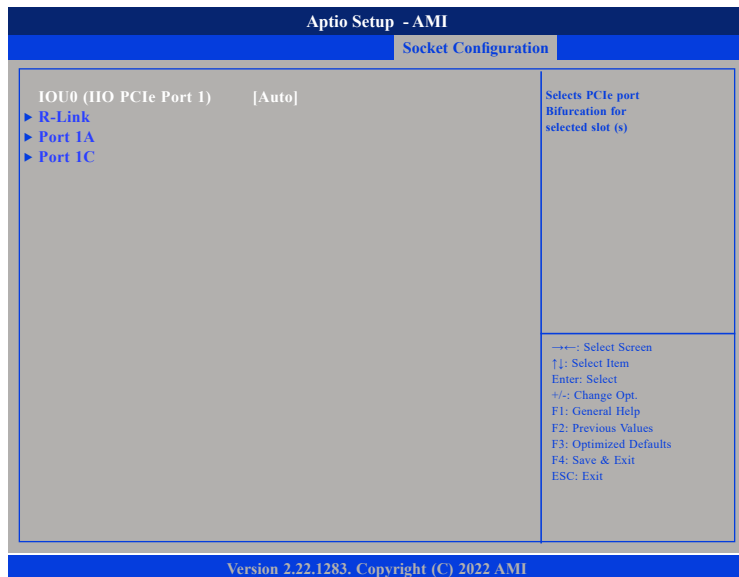

IOU0 (IIO PCIe Port 1)
Port Bifurcation settings for IOU 0.

R-Link

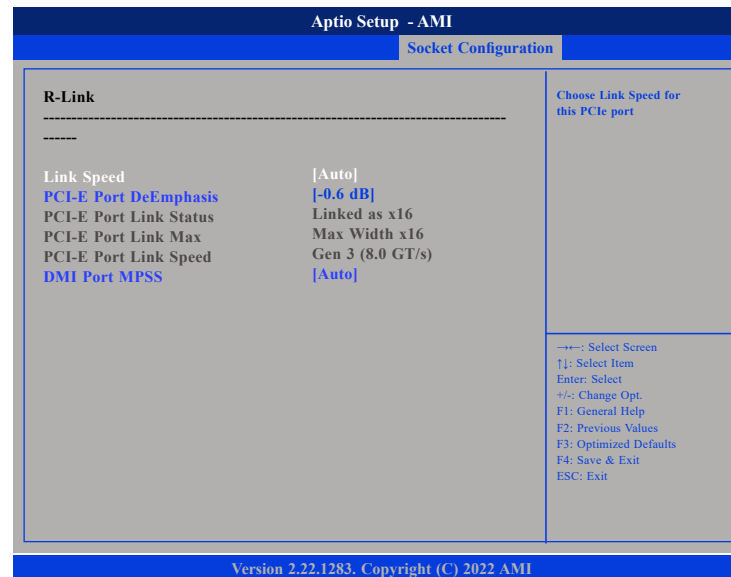

Link Speed

Configures the link speed for the PCIe port.

PCI-E Port DeEmphasis

Configures the de-emphasis control for the PCIe port.

DMI Port MPSS

Configures the DMI Port MPSS.

Port 1A

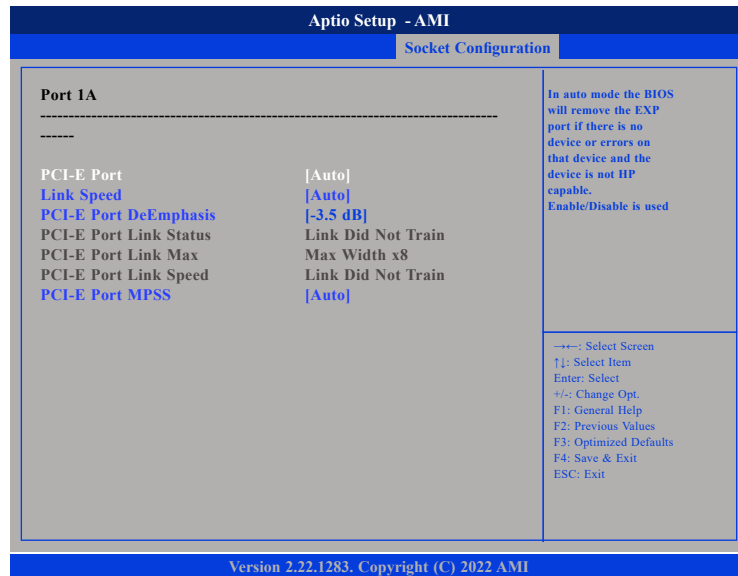

PCI-E Port DeEmphasis

Configures the de-emphasis control for the PCIe port.

PCI-E Port MPSS

Configures the PCIe Port MPSS.

PCI-E Port

Enables or disables the PCIe port. In auto mode the BIOS will remove the EXP port if there is no device or errors on that device and the device is not HP capable. Disable is used to disable the port and hide its CFG space.

Link Speed

Configures the link speed for the PCIe port.

Port 1C

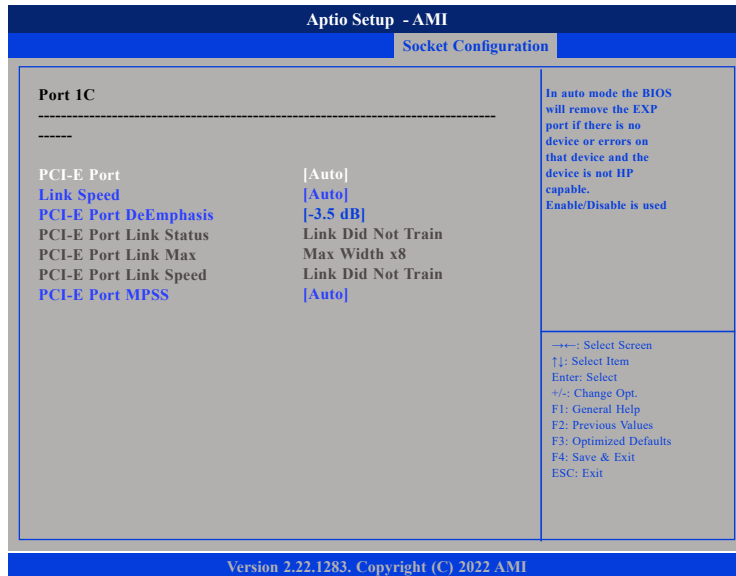

PCI-E Port

Enables or disables the PCIe port. In auto mode the BIOS will remove the EXP port if there is no device or errors on that device and the device is not HP capable. Disable is used to disable the port and hide its CFG space.

Link Speed

Configures the link speed for the PCIe port.

PCI-E Port DeEmphasis

Configures the de-emphasis control for the PCIe port.

PCI-E Port MPSS

Configures the PCIe Port MPSS.

IOAT Configuration

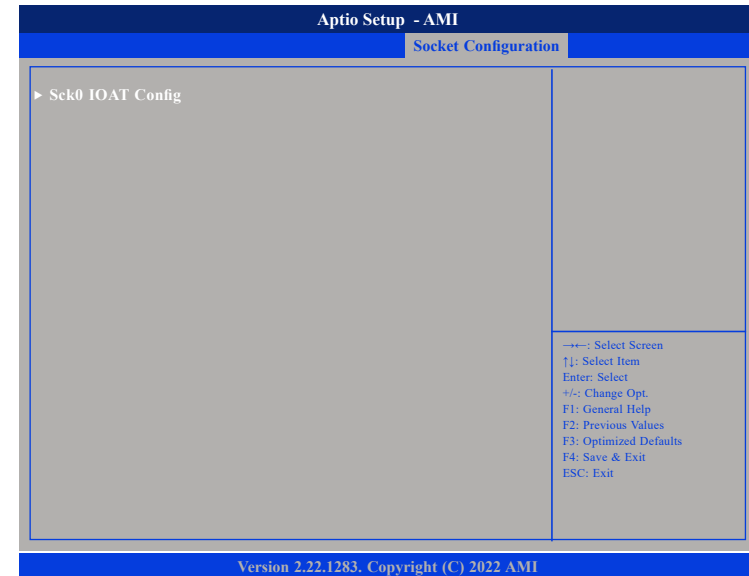

Sck0 IOAT Config

Enters the Socket0 IOAT Configuration submenu.

Sck0 IOAT Configuration

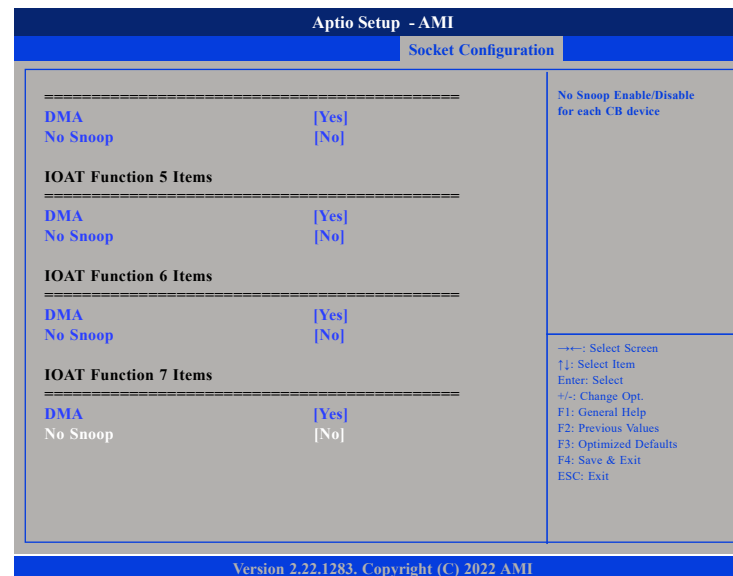
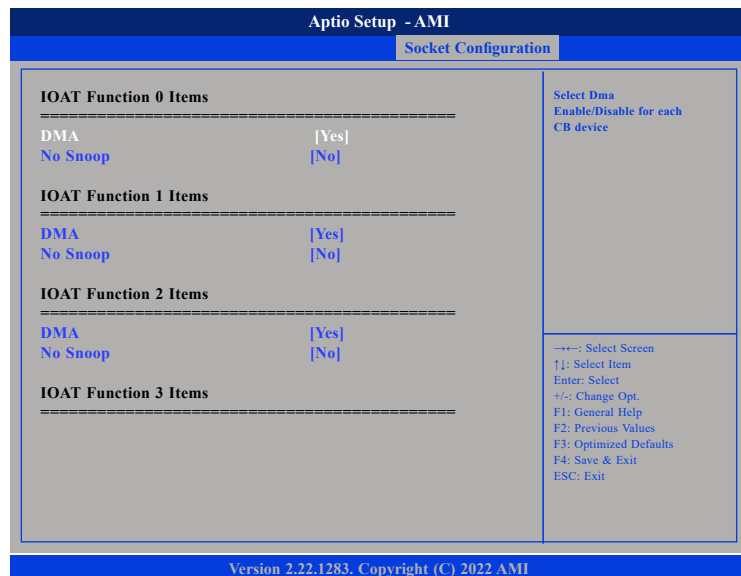

DMA

Enables or disables DMA.

No Snoop

Enables or disables No Snoop function for each CB device.

Intel. VT for Directed I/O (VT-d)

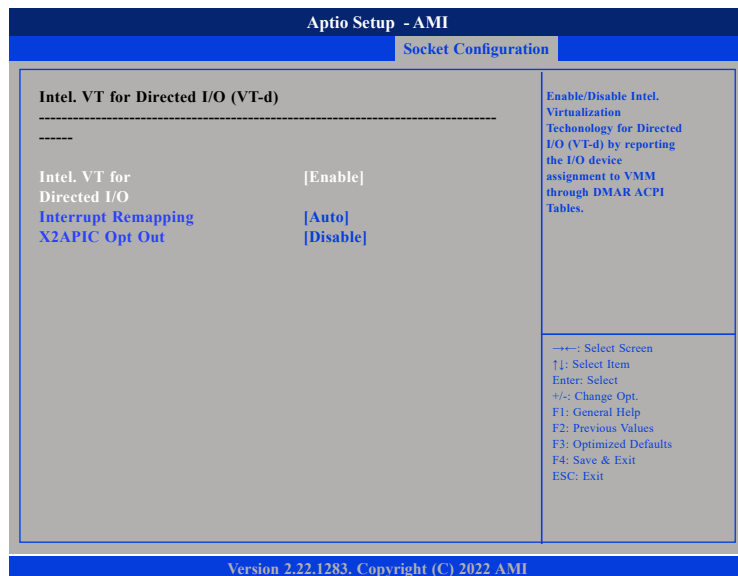

Intel. VT for Directed I/O

Enables or disables Intel® Virtualization Technology for Directed I/O (VT-d) by reporting the I/O device assignment to VMM through DMAR ACPI tables.

Interrupt Remapping

Configures Interrupt Remapping.

X2APIC Opt Out

Enables or disables X2APIC mode.

Advanced Power Management Configuration

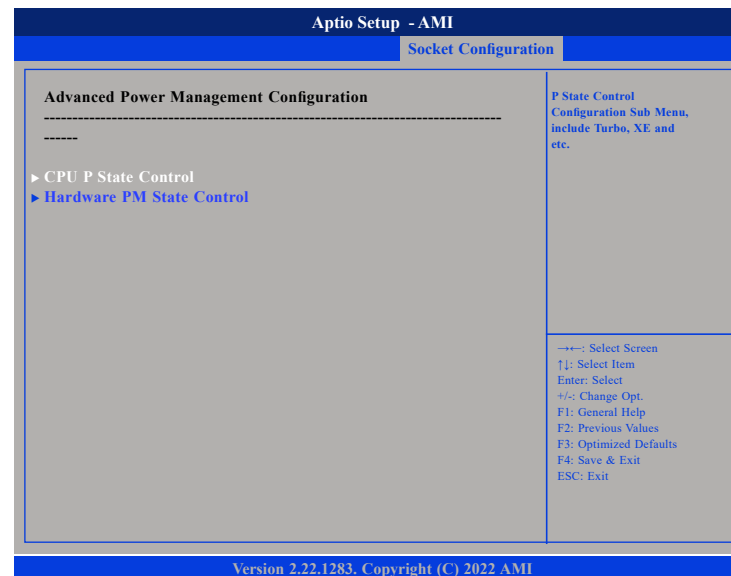

CPU P State Control

Enters the CPU P State Control submenu.

Hardware PM State Control

Enters the Hardware PM State Control submenu

CPU P State Control

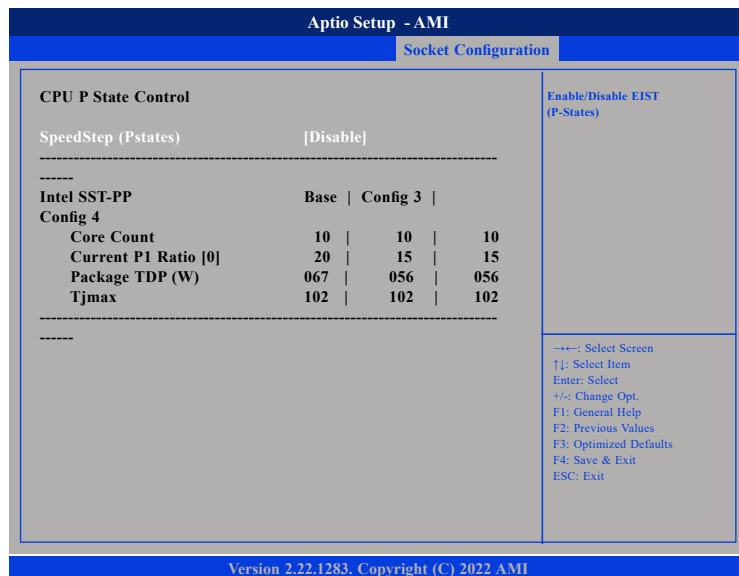

SpeedStep (Pstates)

Enables or disables Intel® SpeedStep technology.

CPU P State Control

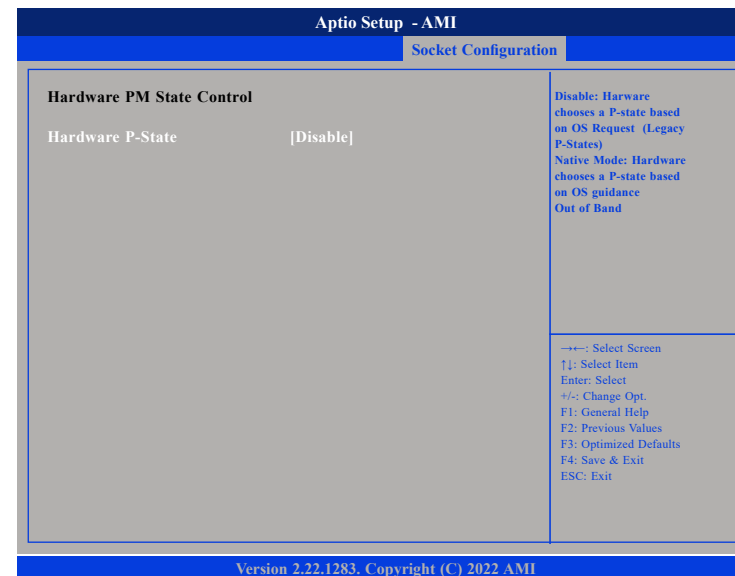

Hardware P-States

- Disable Hardware chooses a P-state based on OS Request. (Legacy P-States).
- Native Mode Hardware chooses a P-state based on OS guidance.
- Out of Band Mode Hardware autonomously chooses a P-state (no OS guidance).

Server Mgmt

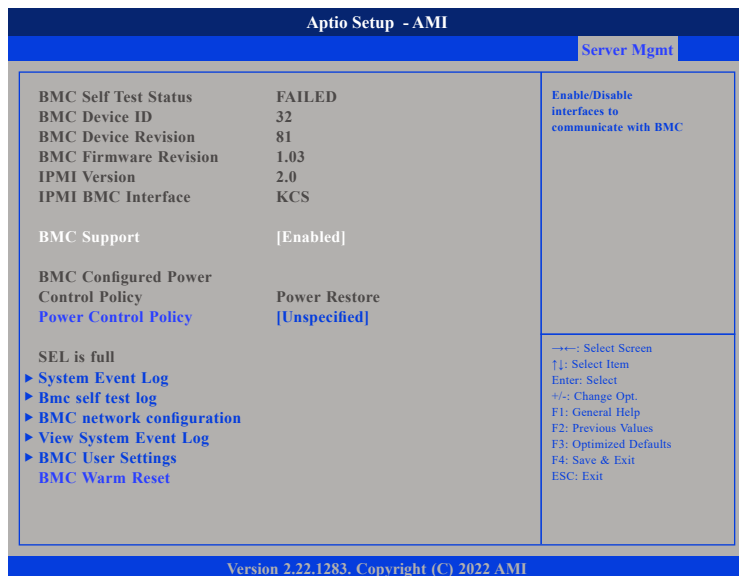

BMC Support

Enables or disables interfaces to communicate with BMC.

BMC Warm Reset

To perform a BMC warm reset, select this field then press <Enter>.

System Event Log

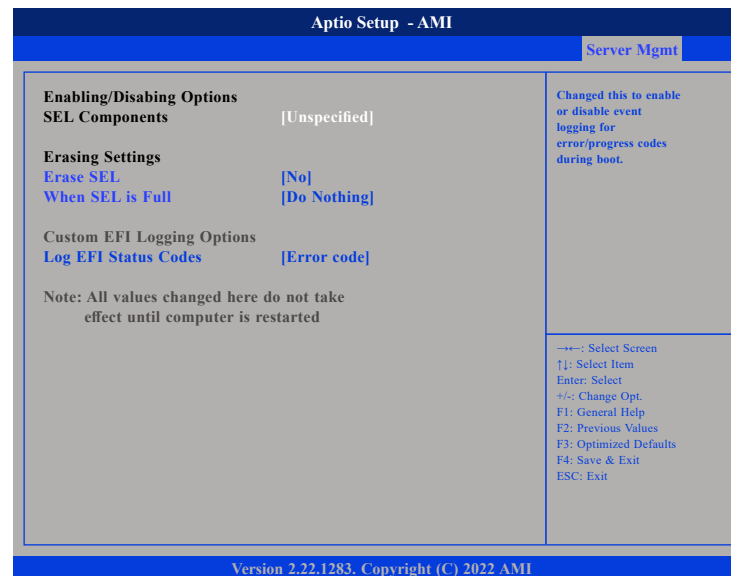

SEL Components

Enables or disables all the features of system event logging during boot.

Erase SEL

Configures the options for erasing SEL.

When SEL is Full

Configures the action to perform when SEL is full.

Log EFI Status Codes

Configures the options for logging EFI status codes.

System Self Test Log

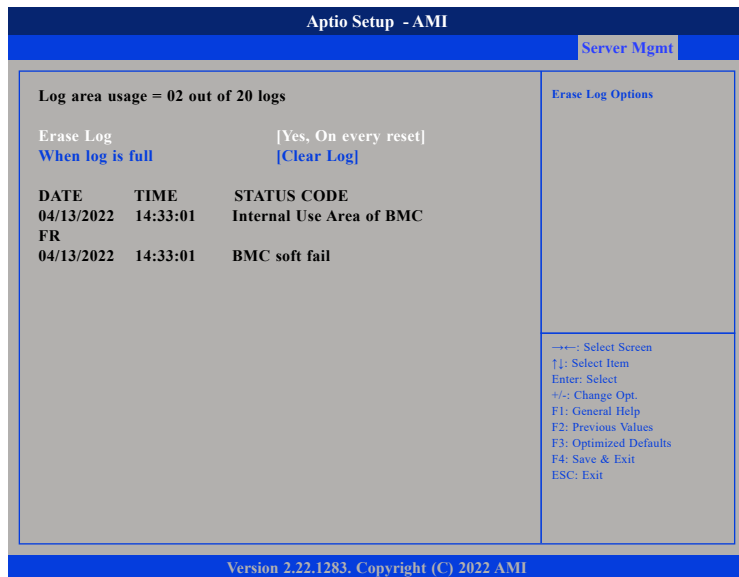

Erase Log

Configures the erase log options.

When Log is Full

Configures the action to perform when log is full

BMC Network Configuration

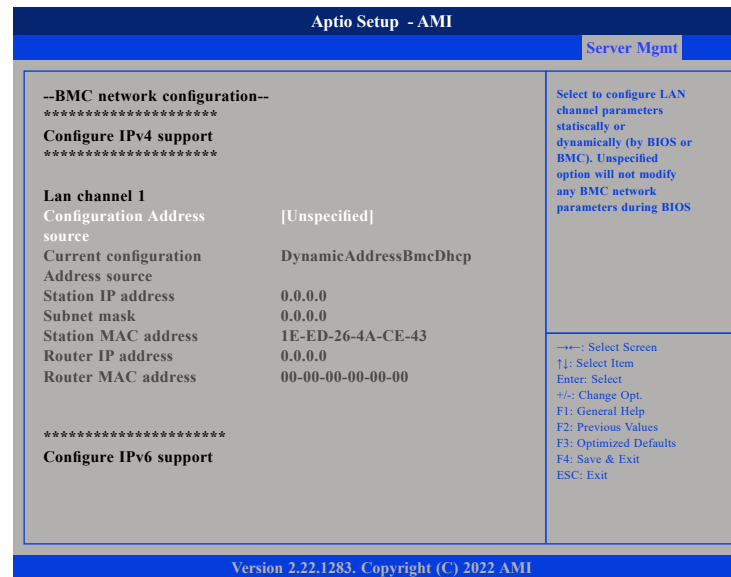

Configuration Address

Select to configure LAN channel parameters statically or dynamically (by BIOS or BMC). Unspecified option will not modify any BMC network parameters during BIOS phase.

BMC Network Configuration Cont.

Aptio Setup - AMI		Server Mgmt
*****		Select to configure LAN channel parameters statically or dynamically (by BIOS or BMC). Unspecified option will not modify any BMC network parameters during BIOS
Lan channel 1		
IPv6 Support	[Enabled]	→←: Select Screen ↑↓: Select Item Enter: Select +/-: Change Opt. F1: General Help F2: Previous Values F3: Optimized Defaults F4: Save & Exit ESC: Exit
Configuration Address source	[Unspecified]	
Current configuration Address source	DynamicAddressBmcDhcp	
Station IPv6 address	::	
Prefix Length	0	
IPv6 address status	Active	
IPv6 DHCP Algorithm	DHCPv6	
Version 2.22.1283. Copyright (C) 2022 AMI		

Aptio Setup - AMI		Server Mgmt
Configuration Router	[Unspecified]	Select to configure LAN channel parameters statically or dynamically (by BIOS or BMC). Unspecified option will not modify any BMC network parameters during BIOS
Lan1 Address source	DynamicAddressBmcDhcp	
Current Router		→←: Select Screen ↑↓: Select Item Enter: Select +/-: Change Opt. F1: General Help F2: Previous Values F3: Optimized Defaults F4: Save & Exit ESC: Exit
Configuration Address source		
IPv6 Router IP Address	::	
IPv6 Router Prefix Length	255	
IPv6 Router Prefix Value	::	

Version 2.22.1283. Copyright (C) 2022 AMI		

IPv6 Support (LAN Channel 1)

Enables or disables IPv6 support for LAN channel 1.

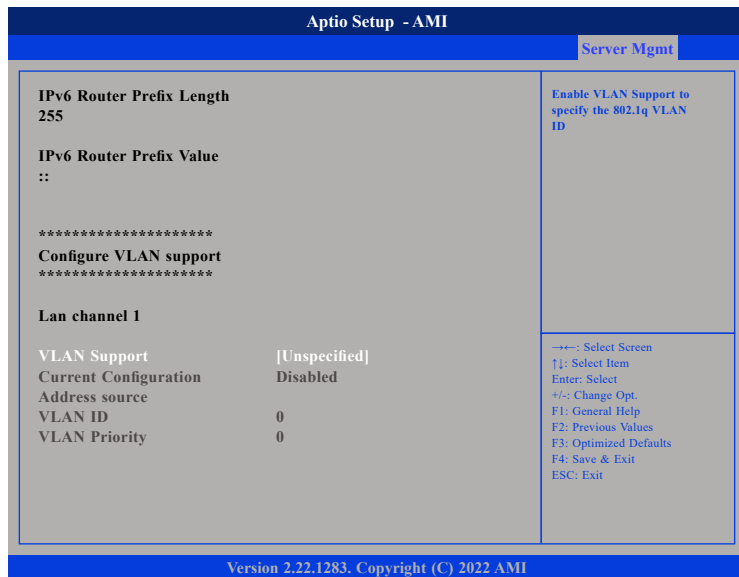

VLAN Support

Enables to specify the 802.1q VLAN ID.

View System Event Log

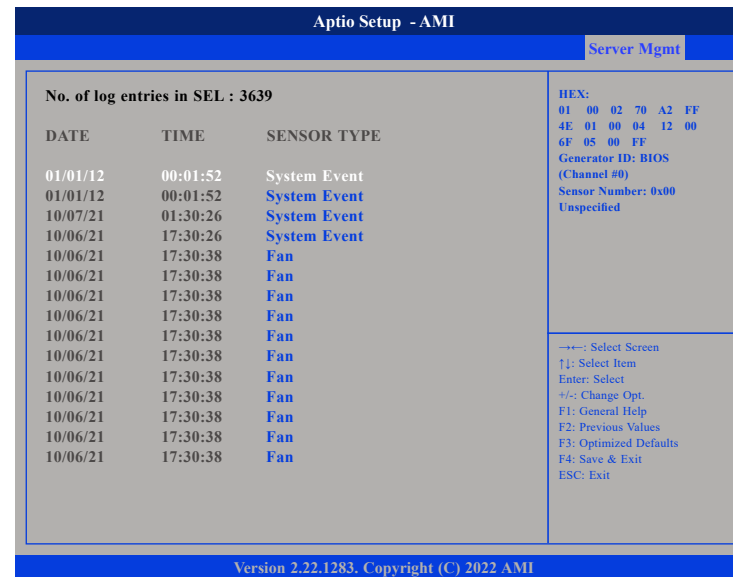

Displays system event log information including date, time and sensor type.

BMC User Settings

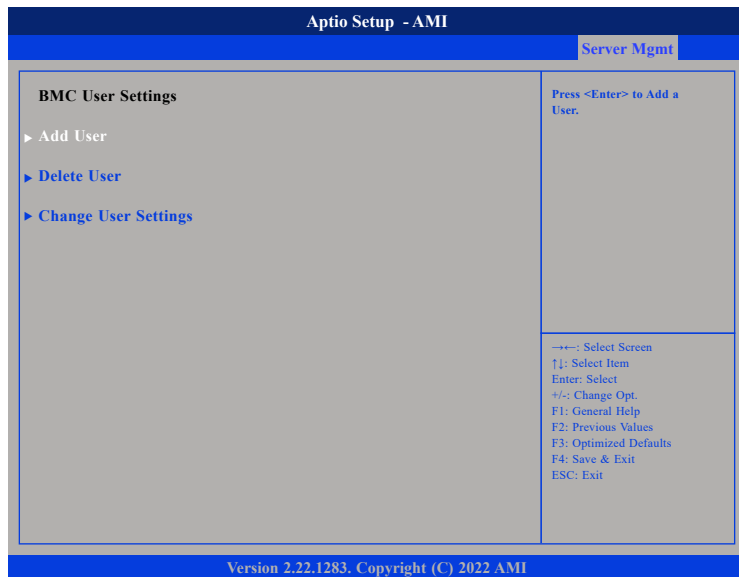

Add User

Option to add a user.

Delete User

Option to delete a user.

Change User Settings

Option to change user settings.

Add User

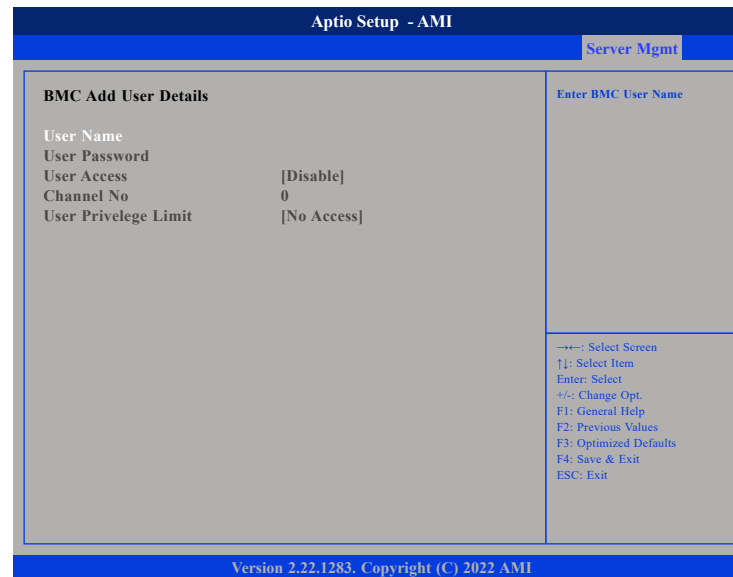

User Name and User Password

Configures the login username and password of the BMC user account.

Channel No and User Privilege Limit

Configures the BMC channel number and account access rights.

Delete User

The screenshot shows the 'BMC Delete User Details' screen in the Aptio Setup - AMI interface. The screen is titled 'Server Mgmt' and contains the following fields and options:

- BMC Delete User Details** (Section Header)
- User Name
- User Password
- Enter BMC User Name (Input field)
- Navigation and function keys:
 - ←: Select Screen
 - ↑↓: Select Item
 - Enter: Select
 - +/-: Change Opt.
 - F1: General Help
 - F2: Previous Values
 - F3: Optimized Defaults
 - F4: Save & Exit
 - ESC: Exit

Version 2.22.1283. Copyright (C) 2022 AMI

User Name and User Password

Specify the login username and password of the BMC user account to delete.

Change User Settings

The screenshot shows the 'BMC Change User Settings' screen in the Aptio Setup - AMI interface. The screen is titled 'Server Mgmt' and contains the following fields and options:

- BMC Change User Settings** (Section Header)
- User Name
- User Password
- Change User Password
- User Access [Disable]
- Channel No 0
- User Privilege Limit [No Access]
- Enter BMC User Name (Input field)
- Navigation and function keys:
 - ←: Select Screen
 - ↑↓: Select Item
 - Enter: Select
 - +/-: Change Opt.
 - F1: General Help
 - F2: Previous Values
 - F3: Optimized Defaults
 - F4: Save & Exit
 - ESC: Exit

Version 2.22.1283. Copyright (C) 2022 AMI

User Name and User Password

Enter the login username and password of the BMC user account that needs to be changed.

Change User Password

Reconfigures a new password for the account.

User Access

Enables or disables this account.

Channel No and User Privilege Limit

Reconfigures the BMC channel number and account access rights.

Security

Aptio Setup - AMI	
Security	
<p>Password Description</p> <p>If ONLY the Administrator's password is set, then this only limits access to Setup and is only asked for when entering Setup. If ONLY the User's password is set, then this is a power on password and must be entered to boot or enter Setup. In Setup the User will have Administrator rights. The password length must be in the following range:</p> <p>Minimum length 3 Maximum length 20</p> <p>Administrator Password</p>	<p>Set Administrator Password</p> <hr/> <p>→←: Select Screen ↑↓: Select Item Enter: Select +/-: Change Opt. F1: General Help F2: Previous Values F3: Optimized Defaults F4: Save & Exit ESC: Exit</p>
Version 2.22.1283. Copyright (C) 2022 AMI	

Administrator Password

Select this to reconfigure the administrator's password.

Boot

Aptio Setup - AMI	
Boot	
<p>Boot Configuration</p> <p>Setup Prompt Timeout 3 Bootup NumLock State [On] Quiet Boot [Disabled]</p> <p>Boot mode select [UEFI] AMI Virtual Devices [Disabled]</p> <p>FIXED BOOT ORDER Priorities</p> <p>Boot Option #1 [Hard Disk] Boot Option #2 [CD/DVD] Boot Option #3 [USB Hard Disk] Boot Option #4 [USB CD/DVD] Boot Option #5 [USB Key: UEFI: KingstonDataTraveler 3.0, Partition 1] Boot Option #6 [USB Floppy] Boot Option #7 [USB Lan] Boot Option #8 [Network]</p> <p>USB Key Drive BBS Priorities</p>	<p>Number of seconds to wait for setup activation key. 65535 (0xFFFF) means indefinite waiting.</p> <hr/> <p>→←: Select Screen ↑↓: Select Item Enter: Select +/-: Change Opt. F1: General Help F2: Previous Values F3: Optimized Defaults F4: Save & Exit ESC: Exit</p>
Version 2.22.1283. Copyright (C) 2022 AMI	

Setup Prompt Timeout

Selects the number of seconds to wait for the setup activation key. 65535(0xFFFF) denotes indefinite waiting.

Bootup NumLock State

This allows you to determine the default state of the numeric keypad. By default, the system boots up with NumLock on wherein the function of the numeric keypad is the number keys. When set to Off, the function of the numeric keypad is the arrow keys.

Quiet Boot

Enabled Displays OEM logo instead of the POST messages.

Disabled Displays normal POST messages.

Boot mode select

Configures the boot mode option.

AMI Virtual Devices

Enables or disables AMI virtual devices.

Boot Option #1 to Boot Option #8

Adjust the boot sequence of the system. Boot Option #1 is the first boot device that the system will boot from, next will be Boot Option #2 and so forth.

USB Key Drive BBS Priorities

Specifies the Boot Device Priority sequence from available UEFI USB Key Drives.

Save & Exit

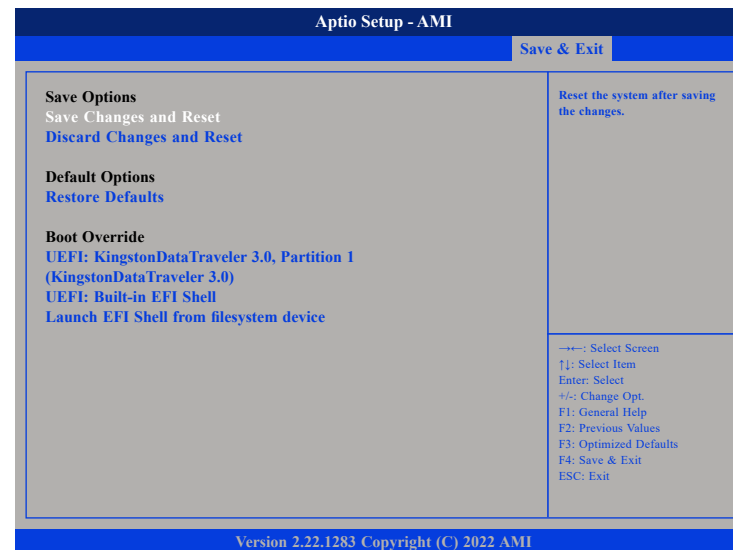

Save Changes and Reset

To save the changes and reset, select this field then press <Enter>. A dialog box will appear. Confirm by selecting Yes.

Discard Changes and Reset

To exit the Setup utility and reset without saving the changes, select this field then press <Enter>. You may be prompted to confirm again before exiting.

Restore Defaults

To restore the BIOS to default settings, select this field then press <Enter>. A dialog box will appear. Confirm by selecting Yes.



Boot Override

To bypass the boot sequence from the Boot Option List and boot from a particular device, select the desired device and press <Enter>.

Launch EFI Shell from filesystem device

To launch EFI shell from a filesystem device, select this field and press <Enter>.

