



# User Manual

Version 1.10

2020/08/19

# HRT-711



Written by Edward Fang  
Edited by Julia Wang

# Table of Contents

---

<b>1. Introduction</b> .....	<b>6</b>
1.1 Features.....	7
1.2 Specification.....	8
<b>2. Hardware</b> .....	<b>9</b>
2.1 Block Diagram.....	9
2.2 Pin Assignment .....	10
2.3 Wiring.....	11
2.3.1 RS-232 .....	11
2.3.2 HART.....	12
2.3.3 Ethernet.....	13
2.4 LED Indicators .....	14
2.5 DIP Switch .....	15
2.6 Jumpers .....	16
2.7 Mounting .....	16
<b>3. HART Introduction</b> .....	<b>17</b>
3.1 Analog and Digital Signal .....	17
3.2 Topology.....	18
3.3 HART Frame .....	20
<b>4. Modbus Communication</b> .....	<b>22</b>
4.1 Module Execution Process.....	22
4.2 Modbus / HART Mapping Table .....	22
4.2.1 Input Data Area – User CMD Data.....	22
4.2.2 Input Data Area – Module State Data.....	22
4.2.3 Input Data Area – Default CMD 0 Data .....	24
4.2.4 Input Data Area – Default CMD 3 Normal Format Data .....	24
4.2.5 Input Data Area – Module Error Record Data .....	25
4.2.6 Input Data Area – Default CMD 0&3 Status Data.....	26
4.2.7 Input Data Area – User CMD Error Status .....	26

4.2.8	Input Data Area – Module Hardware Data .....	27
4.2.9	Input Data Area – Through Mode Data .....	27
4.2.10	Input Data Area – Default CMD 3 Simple Format Data.....	27
4.2.11	Output Data Area.....	28
4.3	Through Mode.....	30
<b>5.</b>	<b>Utility .....</b>	<b>31</b>
5.1	.NET Framework Installation.....	31
5.2	Install HRT-711 Utility.....	33
5.3	Introduction of Utility .....	36
5.4	Configuration of Ethernet .....	36
5.5	Configuration of Modbus to HART .....	37
5.5.1	Traffic Light.....	38
5.5.2	Current Config Module Name.....	38
5.5.3	Connection Status .....	38
5.5.4	Connection Control.....	38
5.5.5	Tools.....	38
<b>6.</b>	<b>FAQ.....</b>	<b>53</b>
Q01	: How to add HART devices to HRT-711 ? .....	53
Q02	: How to make sure that HRT-711 gets the HART device data correctly ? .....	58
Q03	: How to map HART device CMD(3) data directly to SCADA or HMI ? .....	61
Q04	: How to update the firmware of HRT-711 ? .....	69
Q05	: How to read HART device command 1 data with standard format by Modbus ? .....	73
Q06	: How to read HART device command 3 data with standard format by Modbus ? .....	76
Q07	: How to know the connection status between HRT-711 and HART devices ?.....	79
Q08	: How to integrate Active and Passive HART devices in multi-drop network ?.....	82
Q09	: How to integrate multiple HRT-711 modules in the same project ?.....	83
Q10	: How to integrate HART communication device with RS-232 hardware interface ? ..	84
Q11	: How to add the HART Device-Specific command to HRT-711 ? .....	85
Q12	: How to set HART device address by HRT-711 utility ? .....	88
Q13	: All kinds of HART network wiring ? .....	91
Q14	: Apply the same settings to the other HRT-711 rapidly ?.....	94
Q15	: How to send HART command for writing ? (Ex: CMD19).....	96

Q17 : How to get HART command 48 information ? .....	99
Q18 : How to send HART “Burst Mode” CMD? (CMD108/109) .....	102
Q19 : How to reset totalizer value by sending Device-Specific command? .....	107
Q20 : How to read total-flow data from flow-meter?.....	109
Q21 : HART communication update period calculation and adjustment .....	111
Q22 : Integrate HART communication to traditional AI structure.....	113
Q23 : HART Multi-drop mode precautions .....	114
Q24 : HART communication distance issues .....	116
Q25 : Using Through Mode of HG_Tool to Stop Burst Mode of HART Device .....	119
Q26 : How to use the In_Offset field of the UserCMD ? .....	120
Q27: How to use “Listen Only” function to get HART data? .....	125
Q101 : The whole configuration process of HRT-711 ?.....	130
<b>Appendix A HART Command .....</b>	<b>134</b>
<b>Appendix B Command Format .....</b>	<b>140</b>
<b>Appendix C. Revision History .....</b>	<b>141</b>

# Important Information

## Warranty

---

All products manufactured by ICP DAS are under warranty regarding defective materials for a period of one year, beginning from the date of delivery to the original purchaser.

## Warning

---

ICP DAS assumes no liability for any damage resulting from the use of this product. ICP DAS reserves the right to change this manual at any time without notice. The information furnished by ICP DAS is believed to be accurate and reliable. However, no responsibility is assumed by ICP DAS for its use, not for any infringements of patents or other rights of third parties resulting from its use.

## Copyright

---

Copyright © 2017 by ICP DAS Co., Ltd. All rights are reserved.

## Trademark

---

Names are used for identification purpose only and may be registered trademarks of their respective companies.

## Contact us

---

If you encounter any problems while operating this device, feel free to contact us via mail at: [service@icpdas.com](mailto:service@icpdas.com) . We guarantee to respond within 2 working days.

# 1. Introduction

Modbus and HART are two kinds of famous protocols and used wildly in the fields of factory and process automation. The HRT-711 module is a Modbus/TCP and Modbus/UDP to HART gateway. By using this module, users can integrate their HART devices into Modbus network easily. The below figure 1 shows an application example for the HRT-711 module.

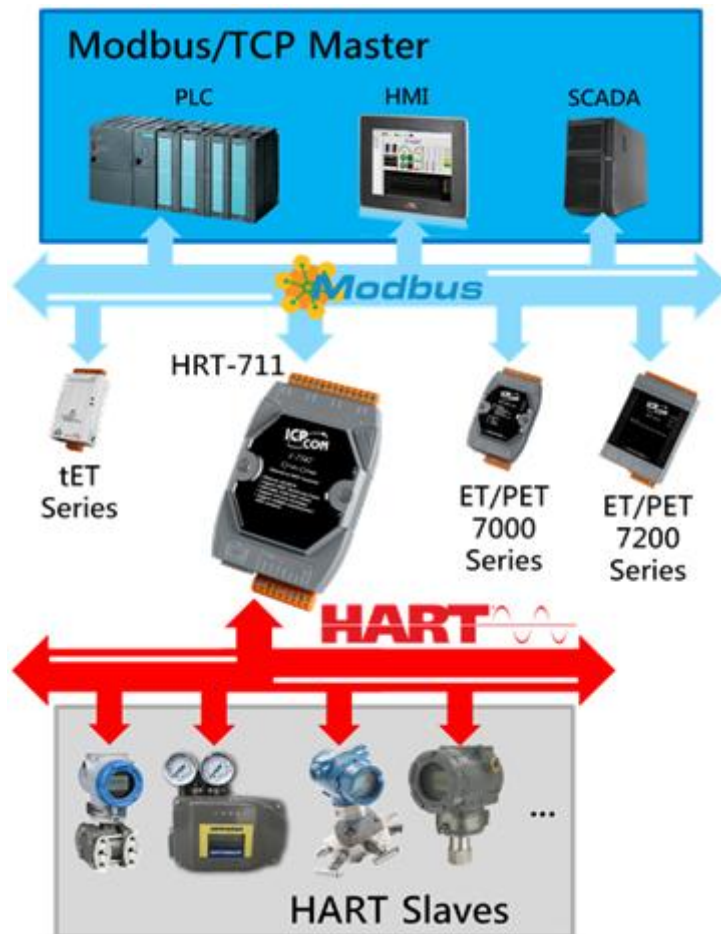

# 1.1 Features

- Support HART Short/Long frame
- Support HART Burst mode
- Allow two HART Masters
- Support Modbus/TCP and Modbus/UDP format
- Support Modbus Slave / HART Master Mode
- Support Firmware Update via Com Port
- Support On-line Replacement of HART Devices
- Support Acquire Long Frame Address Automatically
- Provide LED indicators
- Built-in Watchdog
- DIN-Rail or Wall Mounting

## 1.2 Specification

Item	Specification		
Com Port	RS-232(3 wire)		
	Screwed terminal block		
	Fixed baud rate 115200 bps		
HART	1 HART Modem		
	Screwed terminal block		
	Operates as a HART Master station and supports all HART commands		
	Support Short and Long Frame		
	Support Point to Point or Multi-drop		
	Max. 15 HART modules		
	Max. 100 user commands and 32 default commands		
Ethernet	1 x 10/100Base-TX Ethernet Controller		
	RJ-45		
	Auto Negotiation		
	Auto MDIX		
Power	+10 ~ +30 VDC		
	Power reverse protection and Over-Voltage brown-out protection		
	Power Consumption : 2 W		
Module	Dimensions: 72 mm x 121 mm x 35 mm (W x L x H)		
	Operating temperature: -25 ~ 75 °C		
	Storage temperature: -30 ~ 85 °C		
	Humidity: 5 ~ 95% RH, non-condensing		
	3 x LED indicators		
	<table border="1" data-bbox="416 1585 948 1637"> <tr> <td data-bbox="416 1585 608 1637">ETH LED</td> <td data-bbox="608 1585 948 1637">Network Status</td> </tr> </table>	ETH LED	Network Status
	ETH LED	Network Status	
<table border="1" data-bbox="416 1641 948 1693"> <tr> <td data-bbox="416 1641 608 1693">HART LED</td> <td data-bbox="608 1641 948 1693">HART Status</td> </tr> </table>	HART LED	HART Status	
HART LED	HART Status		
<table border="1" data-bbox="416 1697 948 1747"> <tr> <td data-bbox="416 1697 608 1747">ERR LED</td> <td data-bbox="608 1697 948 1747">Error</td> </tr> </table>	ERR LED	Error	
ERR LED	Error		



## 2. Hardware

### 2.1 Block Diagram

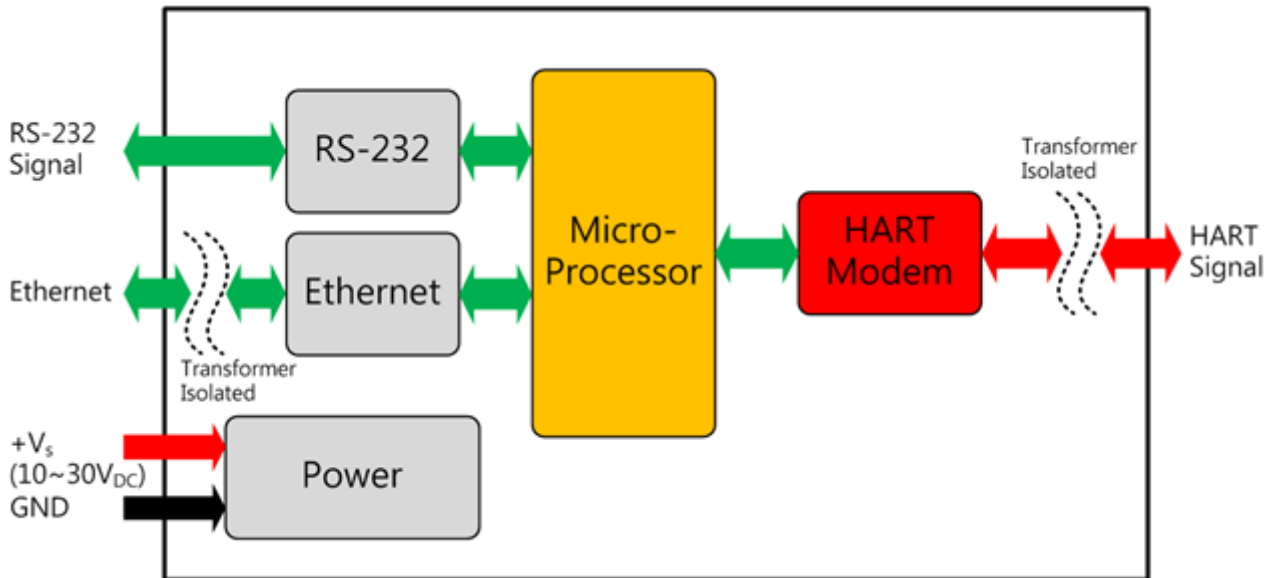

## 2.2 Pin Assignment

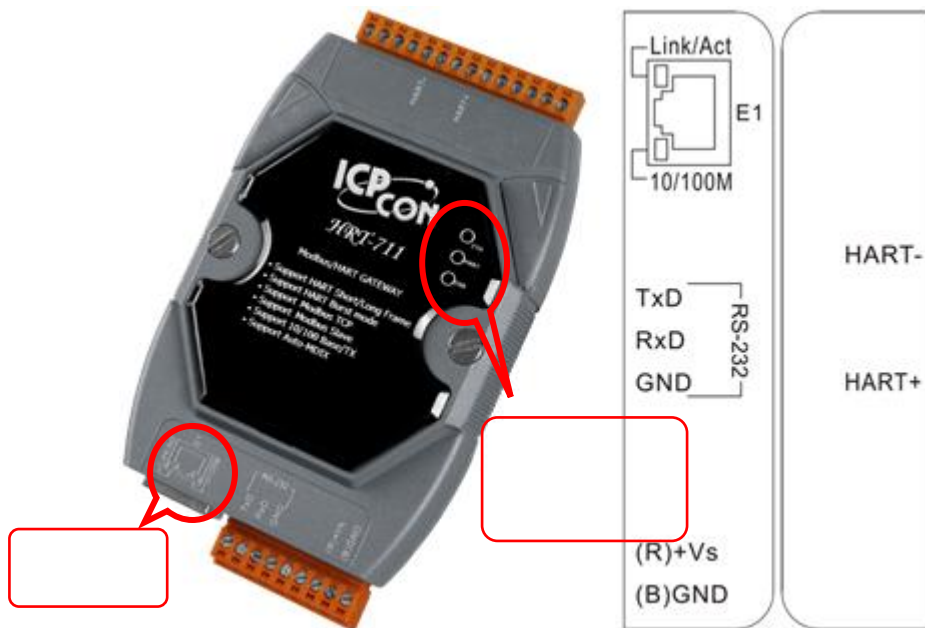

Pin Name	Group	Description
HART+	HART	Positive of HART
HART-		Negative of HART
+VS	Power Source	V+ of Power Supply(+10 ~ +30 VDC)
GND		GND of Power Supply
TXD	Configuration	Transmit Data of RS-232
RXD		Receive Data of RS-232
GND		GND of RS-232
E1	Modbus/TCP Modbus/UDP	Ethernet RJ45 connector for Modbus/TCP and Modbus/UDP

## 2.3 Wiring

In this section, this user's manual will introduce the wiring for each interface.

### 2.3.1 RS-232

The RS-232 port of HRT-711 uses a 3-wire communication interface. It needs a unique cable, CA-0910, to wire from screwed terminal block to D-Sub 9pin connector. Users can choose between using CA-0910 for RS-232 wiring or directly connecting to D-Sub. 2.3.1.1 and 2.3.1.2 are the wiring for the RS-232 interface.

- Without CA-0910

When users choose not to use CA-0910 for RS-232 wiring, users have to have a D-Sub 9pin connector to wire. The following figure is the wiring diagram for wiring without CA-0910.

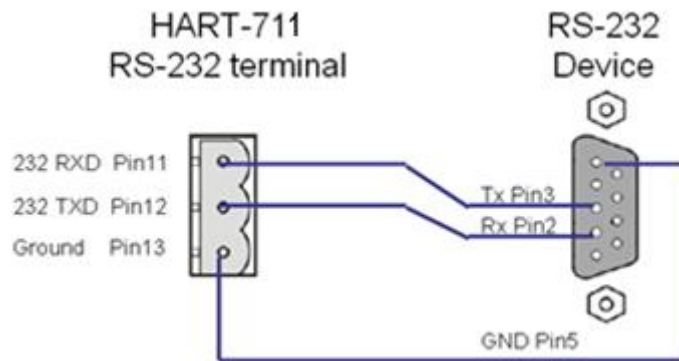

- With CA-0910

It is recommended that users use CA-0910 for wiring the RS-232 port. The wiring of CA-0910 and HRT-711 is shown as below.

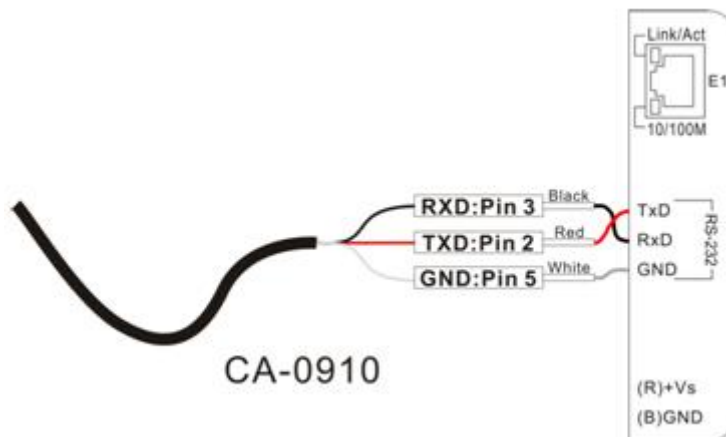

### 2.3.2 HART

The wiring of HART bus can be divided into two types. One is loop power (Passive Loop), and the other is external power (Active Loop). The following figures show the wiring for the HART bus.

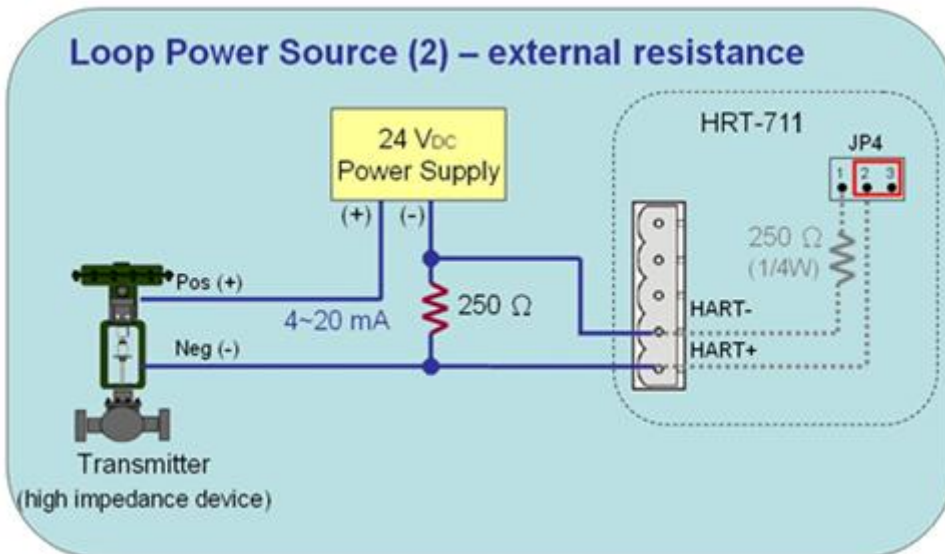
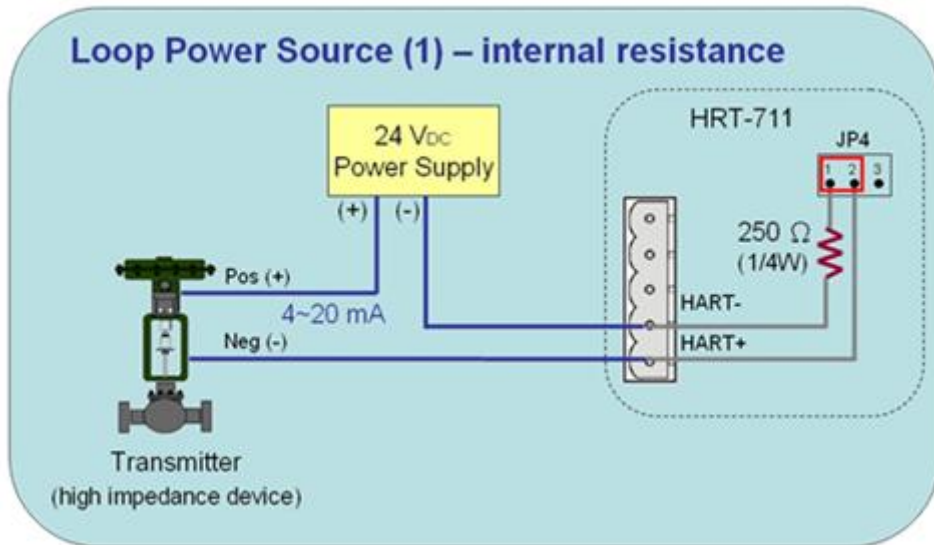

### Loop Power Source (3) – external resistance

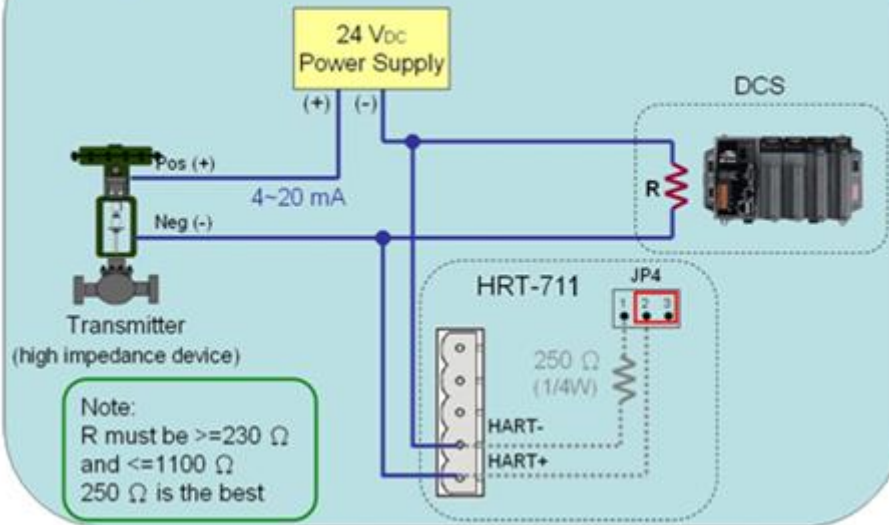

### External Power Source – external resistance

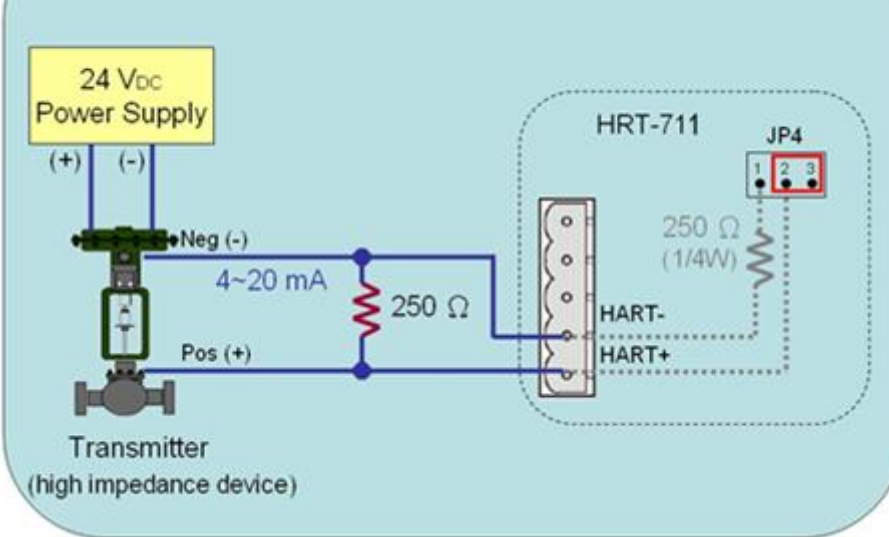

## 2.3.3 Ethernet

The wiring for Ethernet is directly connecting your RJ-45 Ethernet cable to the RJ-45 port on the HRT-711.

## 2.4 LED Indicators

The HRT-711 provides three LED indicators to indicate the module status. The descriptions are shown as follow.

LED	Status	Description
ETH	Blink	Blink every 0.2 second : Receiving Ethernet packet Blink every 3 second : The network function is normal
	Off	Ethernet Error
HART	Blink	Blink every 1 second : The HRT-711 is in the initialing procedure
		Blink every 0.5 second : The HRT-711 is handling the burst frame sent from HART device
	Solid	The HRT-711 is in the normal status
	Off	Firmware is not loaded
ERR	Blink	HART communication error
	Off	HART communication is good



## 2.5 DIP Switch

The DIP switch is used for switching the mode between Init and Normal. The switch is located on the back of the module. On the init side, the module can be configured through Utility. On the normal side, the module is a gateway between HART and Modbus/TCP, Modbus/UDP protocol. Users have to power cycle the module when switch to different mode.



## 2.6 Jumpers

There are three jumpers for enabling/disabling function. The description for each jumper is shown as following table.

Jumper	Description
JP2	(1) Position 1 & 2 : Enable hardware WDT. (Default setting) (2) Position 2 & 3 : Firmware Update Mode. (JP3 should be also in the 2 & 3)
JP3	(1) Position 1 & 2 : Firmware Operation Mode. (Default setting) (2) Position 2 & 3 : Firmware Update Mode. (JP2 should be also in the 2 & 3) => The detailed steps of Firmware Update, please refer to the Q04 of FAQ.
JP4	The jumper can provide HART bus with 250 $\Omega$ (1/4 W) resistor. When the pin 1&2 of of JP4 is closed, the resistor will connect to HART bus. When the pin 2&3 of JP4 is closed or JP4 without jumper connected, it will disconnect the resistor from HART bus. By default, the pin1&2 of JP4 is closed. Please refer to section 2.3.2.

## 2.7 Mounting

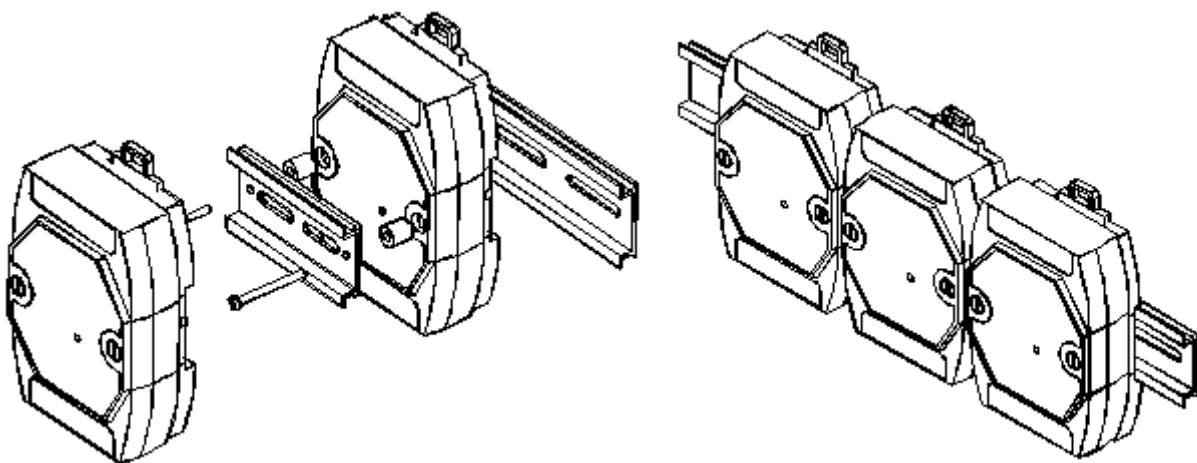



### 3. HART Introduction

#### 3.1 Analog and Digital Signal

The HART communication protocol is based on the Bell 202 telephone communication standard and operates using the frequency shift keying (FSK, Figure 14) principle. The digital signal is made up of two frequencies - 1,200 Hz and 2,200 Hz representing bits 1 and 0, respectively. Sine waves of these two frequencies are superimposed on the direct current (dc) analog signal cables to provide simultaneous analog and digital communications.

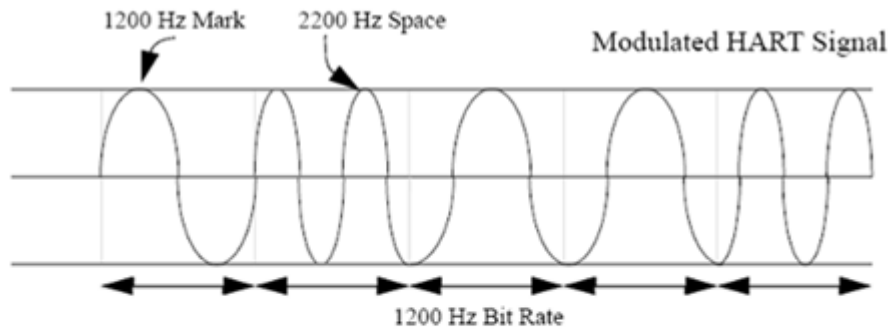

Frequency-Shift-Keying	
1200 Hz	: 1
2200 Hz	: 0

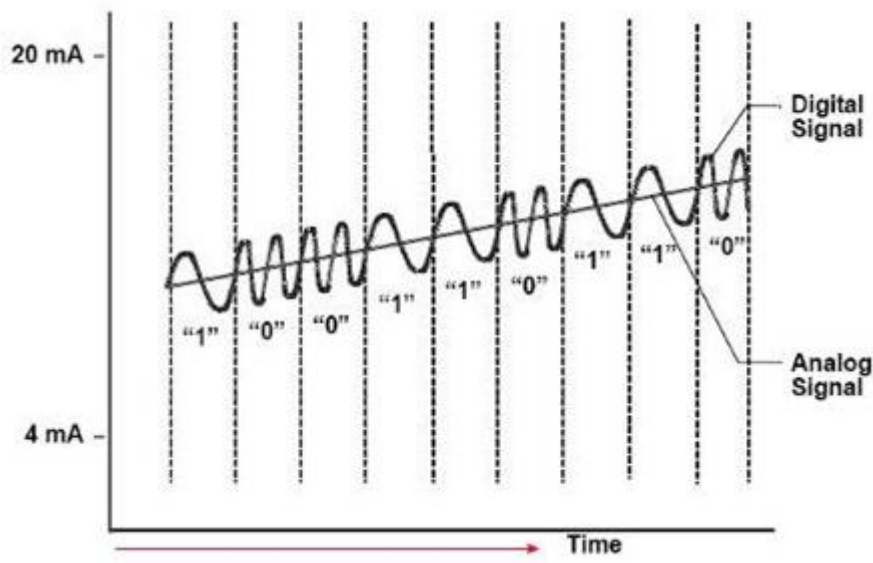

## 3.2 Topology

HART bus can operate in one of the two network configurations, point to point and multi-drop.

### Point to Point

In point to point mode, the analog signal is used to communicate one process variable and the digital signal gives access to secondary variables and other data that can be used for operations, commissioning, maintenance and diagnostic purposes. Only one HART slave device can exist in HART bus and the polling address must be zero.

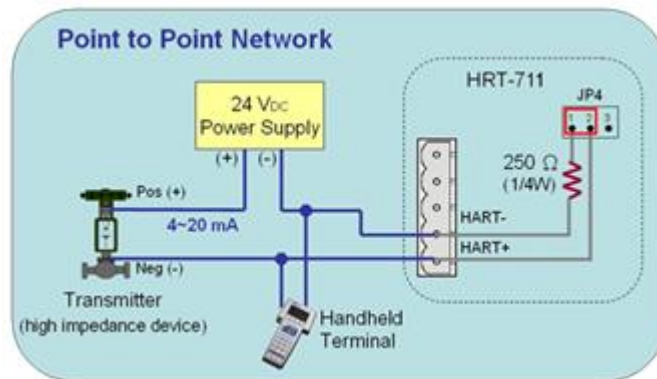

### Multi-drop

In multi-drop mode, all process values are transmitted digitally. The polling address of all field devices must be bigger than 0 and between 1 ~ 15. The current through each device is fixed to a minimum value (typically 4 mA). The maximum HART device number in HART bus is up to 15.

NOTE : The built-in resistor in HRT-711 is 250 Ohm with 1/4W. Therefore, HRT-711 supports to connect the maximum 7 HART devices simultaneously. If the HART devices in multi-drop mode are more than 7, then users need to disconnect the built-in resistor in HRT-711 (prevent to burn down) and use an external 250 Ohm resistor with 1W.

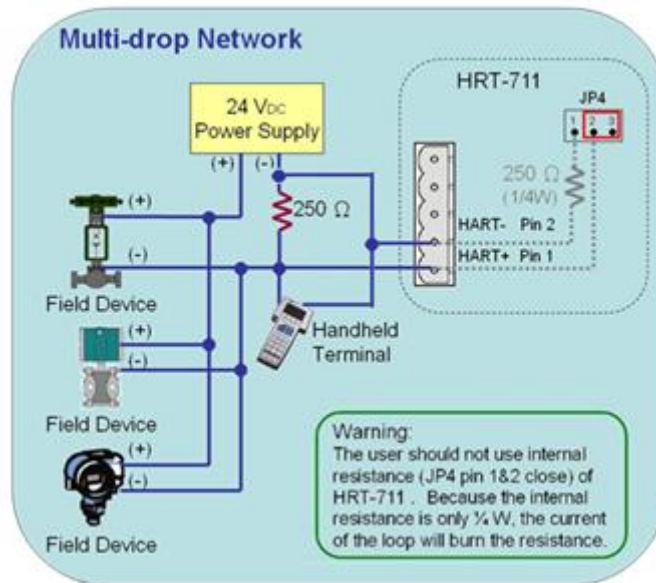

### 3.3 HART Frame

The HART frame format is shown as below.



Master to Slave Frame

Slave to Master Frame

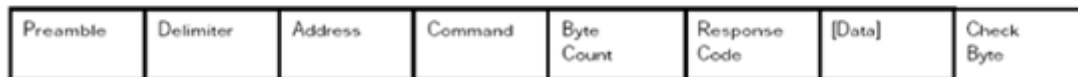

Field	Description																											
Preamble	All frames transmitted by HART master or slave devices are preceded by a specified number of "0xFF" characters and they are called the preamble. The number of preamble can't be less than 5 and more than 20																											
Delimiter	This data can indicate the frame is long or short frame and the frame is master frame, slave frame or burst frame.																											
Address	If the HART frame is short frame, the address field is only one byte. If it is long frame, the address field are 5 bytes and include manufacturer ID, device type and device ID.																											
Command	<p>The HART command set can be divided into Universal, Common Practice and Device-Specific class. These three class shown as below :</p> <table border="1"> <tr> <th>Command Number</th> <th>Command Class</th> </tr> <tr> <td>Universal</td> <td>0~30, 31 is reserved</td> </tr> <tr> <td>Common Practice</td> <td>32~126, 127 is reserved</td> </tr> <tr> <td>Device-Specific</td> <td>128~253</td> </tr> <tr> <td>Reserved</td> <td>254 &amp; 255</td> </tr> </table> <p>Please refer to Appendix A for more detail of HART command</p>	Command Number	Command Class	Universal	0~30, 31 is reserved	Common Practice	32~126, 127 is reserved	Device-Specific	128~253	Reserved	254 & 255																	
Command Number	Command Class																											
Universal	0~30, 31 is reserved																											
Common Practice	32~126, 127 is reserved																											
Device-Specific	128~253																											
Reserved	254 & 255																											
Byte Count	It is the number of bytes between it and the check byte the end of the HART frame.																											
Response Code	<p>It includes two bytes of status. These bytes convey three types of information: Communication errors, Command response problems and Field device status. They are shown as below.</p> <table border="1"> <tr> <td>Response Code Data</td> <td>Byte1</td> <td>Byte0</td> </tr> </table> <p>NOTE : When first byte shows the communication error, the value of the second byte is 0</p> <table border="1"> <tr> <td colspan="8">Byte 0 represents the communication error or response code</td> </tr> <tr> <td colspan="8">This byte is used for error status when Bit7 is 1. The status bits are shown as follow</td> </tr> <tr> <td>Bit7</td> <td>Bit6</td> <td>Bit5</td> <td>Bit4</td> <td>Bit3</td> <td>Bit2</td> <td>Bit1</td> <td>Bit0</td> </tr> </table>	Response Code Data	Byte1	Byte0	Byte 0 represents the communication error or response code								This byte is used for error status when Bit7 is 1. The status bits are shown as follow								Bit7	Bit6	Bit5	Bit4	Bit3	Bit2	Bit1	Bit0
Response Code Data	Byte1	Byte0																										
Byte 0 represents the communication error or response code																												
This byte is used for error status when Bit7 is 1. The status bits are shown as follow																												
Bit7	Bit6	Bit5	Bit4	Bit3	Bit2	Bit1	Bit0																					

Field	Description								
	1	Parity Error	Overrun error	Framing Error	Checksum error	0(Reserved)	RX buffer overflow	Overflow (Undefined)	
	This byte is used for response code when Bit7 is 0.								
		Bit7	Bit6	Bit5	Bit4	Bit3	Bit2	Bit1	Bit0
		0	Response Code						
		<b>Response Code</b>		<b>Description</b>					
			0	No command-specific error					
			1	Undefined					
			2	Invalid selection					
			3	Passed parameter too large					
			4	Passed parameter too small					
		5	Too few data bytes received						
		6	Device-specific command error (rarely used)						
		7	In write-protect mode						
		8~15	Multiple meanings						
		16	Access restricted						
		28	Multiple meanings						
		32	Device is busy						
		64	Command not implemented						
	Byte 1 indicates field device status								
		Bit 7	Field device malfunction						
		Bit 6	Configuration changed						
		Bit 5	Cold start						
		Bit 4	More status available						
		Bit 3	Analog output current fixed						
		Bit 2	Analog output saturated						
		Bit 1	Non-primary variable out of limits						
		Bit 0	Primary variable out of limits						
Data	The contents of the data are decided by HART command number.								
Check Byte	Every HART frame has a check byte at the last data byte. HART device can detect error frame by this byte.								

## 4. Modbus Communication

### 4.1 Module Execution Process

When the HRT-711 module is started, it will perform the Initial mode first and then the Operation mode.

- (1) When HRT-711 runs under Initial mode, it will execute all initial command and the HART LED will flash.
- (2) When HRT-711 runs under Operation mode, it will execute all polling command automatically and the HART LED will always on.

### 4.2 Modbus / HART Mapping Table

Users can access the HART device by using these Modbus address defined by HRT-711 module. These Modbus address can be divided into two parts as below.

- (1) Input Data Area (FC04)
- (2) Output Data Area (FC06, FC16)

**[ Note ]**

The meaning of every Modbus address in the below table is based on the setting of SWAP Mode to be None. If the setting of SWAP Mode is Byte or WORD or W&B, then the meaning of every Modbus address in the below table will be moved one byte or word address

#### 4.2.1 Input Data Area – User CMD Data

Modbus Addr (Hexadecimal)	Modbus Addr (Decimal)	Description
0x0~1F3	0~499	User CMD Data

#### 4.2.2 Input Data Area – Module State Data

Modbus Addr (Hexadecimal)	Modbus Addr (Decimal)	Description	
0x1F4	500	High Byte	Low Byte
		Module request command count <sup>(2)</sup>	Module state machine <sup>(1)</sup>
0x1F5	501	High Byte	Low Byte
		Module receive error command count <sup>(2)</sup>	Module receive command count <sup>(2)</sup>

Modbus Addr (Hexadecimal)	Modbus Addr (Decimal)	Description	
0x1F6	502	High Byte	Low Byte
		Module error command index <sup>(4)</sup>	Module error status <sup>(3)</sup>
0x1F7~1F9	503~505	Reserved	

NOTE 1 : The module state machine represents current state of command handling. The meanings of the states are shown in the following table.

Value	Status
0	Idle
1	Waiting to send HART command
2	Sending HART command.
3	Waiting to receive HART data
4	Receiving HART data.

NOTE 2 : In HRT-711, the module request and receive command and error count are used 1 byte respectively. Each request, receive or error will increase this byte until 256, then the value will start from 0 again.

NOTE 3 : The module error status records the latest error status. The status is shown as following table.

Value	Error Status
0	No error
1	The command has never be executed
2	Receive timeout, can't receive any HART data
3	Receive HART data is too short
4	The delimiter of HART data has some error
5	The address (the bit of master type) of HART data has some error
6	The address (the bit of burst mode) of HART data has some error
7	The command of HART data has some error
8	The parity of HART data has error
9	The communication with HART slave device has some error and the error messages are recorded in the responses codes

NOTE 4 : The module command index records the latest command index. There is no error occur when this byte is 255.

### 4.2.3 Input Data Area – Default CMD 0 Data

The HRT-711 will automatically add two default commands, CMD 0 and CMD 3, when add a HART device. The following table represents the default CMD 0 data Modbus address mapping.

Modbus Addr (Hexadecimal)	Modbus Addr (Decimal)	Description
0x1FA~200	506~512	Default CMD 0 input data of Module 0
0x201~207	513~519	Default CMD 0 input data of Module 1
0x208~20E	520~526	Default CMD 0 input data of Module 2
0x20F~215	527~533	Default CMD 0 input data of Module 3
0x216~21C	534~540	Default CMD 0 input data of Module 4
0x21D~223	541~547	Default CMD 0 input data of Module 5
0x224~22A	548~554	Default CMD 0 input data of Module 6
0x22B~231	555~561	Default CMD 0 input data of Module 7
0x232~238	562~568	Default CMD 0 input data of Module 8
0x239~23F	569~575	Default CMD 0 input data of Module 9
0x240~246	576~582	Default CMD 0 input data of Module 10
0x247~24D	583~589	Default CMD 0 input data of Module 11
0x24E~254	590~596	Default CMD 0 input data of Module 12
0x255~25B	597~603	Default CMD 0 input data of Module 13
0x25C~262	604~610	Default CMD 0 input data of Module 14
0x263~269	611~617	Default CMD 0 input data of Module 15

### 4.2.4 Input Data Area – Default CMD 3 Normal Format Data

When configure HRT-711 default CMD 3 to normal format, the data of Modbus address for each HART device is shown as following table.

Byte 0	Byte 1	Byte 2	Byte 3	Byte 4
Unit	Primary Variable of HART device (In IEEE 754 format)			
Byte 5	Byte 6	Byte 7	Byte 8	Byte 9
Unit	Secondary Variable of HART device (In IEEE 754 format)			
Byte 10	Byte 11	Byte 12	Byte 13	Byte 14
Unit	Tertiary Variable of HART device (In IEEE 754 format)			
Byte 15	Byte 16	Byte 17	Byte 18	Byte 19
Unit	Quaternary Variable of HART device (In IEEE 754 format)			



Modbus Addr (Hexadecimal)	Modbus Addr (Decimal)	Description
0x26A~276	618~630	Default CMD 3 Normal Format Data of Module 0
0x277~283	631~643	Default CMD 3 Normal Format Data of Module 1
0x284~290	644~656	Default CMD 3 Normal Format Data of Module 2
0x291~29D	657~669	Default CMD 3 Normal Format Data of Module 3
0x29E~2AA	670~682	Default CMD 3 Normal Format Data of Module 4
0x2AB~2B7	683~695	Default CMD 3 Normal Format Data of Module 5
0x2B8~2C4	696~708	Default CMD 3 Normal Format Data of Module 6
0x2C5~2D1	709~721	Default CMD 3 Normal Format Data of Module 7
0x2D2~2DE	722~734	Default CMD 3 Normal Format Data of Module 8
0x2DF~2EB	735~747	Default CMD 3 Normal Format Data of Module 9
0x2EC~2F8	748~760	Default CMD 3 Normal Format Data of Module 10
0x2F9~305	761~773	Default CMD 3 Normal Format Data of Module 11
0x306~312	774~786	Default CMD 3 Normal Format Data of Module 12
0x313~31F	787~799	Default CMD 3 Normal Format Data of Module 13
0x320~32C	800~812	Default CMD 3 Normal Format Data of Module 14
0x32D~339	813~825	Default CMD 3 Normal Format Data of Module 15

#### 4.2.5 Input Data Area – Module Error Record Data

The HRT-711 records the latest 3 error when HART communication has error. These 3 records are put in the module error record. The format of each record is shown as following table.

Byte 0	The length of send data
Byte 1~53	The record of send data
Byte 54	The length of receive data
Byte 55~109	The record of receive data
Byte 110~113	The time stamp record
Byte 114~115	Reserved

Modbus Addr (Hexadecimal)	Modbus Addr (Decimal)	Description
0x33A~373	826~883	Module Error Record 1
0x374~3AD	884~941	Module Error Record 2
0x3AE~3E7	942~999	Module Error Record 3

#### 4.2.6 Input Data Area—Default CMD 0&3 Status Data

It consists of two bytes. The first byte is the state of Default CMD 0 and the second byte is the state of Default CMD 3.

Ex: If the value is 0x0100 for the MB address 1000, then the low byte of the 1000 is 0x00 and the high byte of the 1000 is 0x01. It means the error status of Default CMD 0 is 0x00 and the error status of Default CMD 3 is 0x01 in Module 0.

High Byte	Low Byte
CMD 3 Status	CMD 0 Status

Modbus Addr (Hexadecimal)	Modbus Addr (Decimal)	Description
0x3E8	1000	Default CMD 0&3 status of Module 0
0x3E9	1001	Default CMD 0&3 status of Module 1
0x3EA	1002	Default CMD 0&3 status of Module 2
0x3EB	1003	Default CMD 0&3 status of Module 3
0x3EC	1004	Default CMD 0&3 status of Module 4
0x3ED	1005	Default CMD 0&3 status of Module 5
0x3EE	1006	Default CMD 0&3 status of Module 6
0x3EF	1007	Default CMD 0&3 status of Module 7
0x3F0	1008	Default CMD 0&3 status of Module 8
0x3F1	1009	Default CMD 0&3 status of Module 9
0x3F2	1010	Default CMD 0&3 status of Module 10
0x3F3	1011	Default CMD 0&3 status of Module 11
0x3F4	1012	Default CMD 0&3 status of Module 12
0x3F5	1013	Default CMD 0&3 status of Module 13
0x3F6	1014	Default CMD 0&3 status of Module 14
0x3F7	1015	Default CMD 0&3 status of Module 15
0x3F8~419	1016~1049	Reserved

#### 4.2.7 Input Data Area—User CMD Error Status

The HRT-711 supports maximum 100 User CMDs. The index of the User CMD is from 0 to 99. Each Modbus address represents two User CMD statuses.

Ex: If the value is 0x0200 for the MB address 1050, then the low byte of the 1050 is 0x00

and the high byte of the 1050 is 0x02. It means the error status of User CMD Index 0 is 0x00 and the error status of User CMD Index 1 is 0x02.

Modbus Addr (Hexadecimal)	Modbus Addr (Decimal)	Description
0x41A~44B	1050~1099	User CMD Index 0~99 error status

#### 4.2.8 Input Data Area – Module Hardware Data

Modbus Addr (Hexadecimal)	Modbus Addr (Decimal)	Description
0x44C~44D	1100~1101	Module ID (An ASCII value to represent HART)
0x44E~455	1102~1109	Module Name (An ASCII value to represent the 16-byte module name)
0x456~459	1110~1113	Module Firmware Version (An ASCII value to represent the 8-byte firmware version)
0x45A~47D	1114~1149	Reserved

#### 4.2.9 Input Data Area – Through Mode Data

Modbus Addr (Hexadecimal)	Modbus Addr (Decimal)	Description	
0x47E	1150	High Byte	Low Byte
		Receive count in through mode	Send count in through mode
0x47F	1151	High Byte	Low Byte
		Reserved	Receive error count in through mode
0x480	1152	Receive length in through mode	
0x481~50E	1153~1294	Receive data in through mode	
0x50F~513	1295~1299	Reserved	

#### 4.2.10 Input Data Area – Default CMD 3 Simple Format Data

When configure HRT-711 default CMD 3 to simple format, the data of Modbus address for each HART device is shown as following table.

Byte 0	Byte 1	Byte 2	Byte 3
Primary Variable of HART device (In IEEE 754 format)			
Byte 4	Byte 5	Byte 6	Byte 7
Secondary Variable of HART device (In IEEE 754 format)			

Byte 8	Byte 9	Byte 10	Byte 11
Tertiary Variable of HART device (In IEEE 754 format)			
Byte 12	Byte 13	Byte 14	Byte 15
Quaternary Variable of HART device (In IEEE 754 format)			

Modbus Addr (Hexadecimal)	Modbus Addr (Decimal)	Description
0x514~51D	1300~1309	Default CMD 3 Simple Format data of Module 0
0x51E~527	1310~1319	Default CMD 3 Simple Format data of Module 1
0x528~531	1320~1329	Default CMD 3 Simple Format data of Module 2
0x532~53B	1330~1339	Default CMD 3 Simple Format data of Module 3
0x53C~545	1340~1349	Default CMD 3 Simple Format data of Module 4
0x546~54F	1350~1359	Default CMD 3 Simple Format data of Module 5
0x550~559	1360~1369	Default CMD 3 Simple Format data of Module 6
0x55A~563	1370~1379	Default CMD 3 Simple Format data of Module 7
0x564~56D	1380~1389	Default CMD 3 Simple Format data of Module 8
0x56E~577	1390~1399	Default CMD 3 Simple Format data of Module 9
0x578~581	1400~1409	Default CMD 3 Simple Format data of Module 10
0x582~58B	1410~1419	Default CMD 3 Simple Format data of Module 11
0x58C~595	1420~1429	Default CMD 3 Simple Format data of Module 12
0x596~59F	1430~1439	Default CMD 3 Simple Format data of Module 13
0x5A0~5A9	1440~1449	Default CMD 3 Simple Format data of Module 14
0x5AA~5B3	1450~1459	Default CMD 3 Simple Format data of Module 15

#### 4.2.11 Output Data Area

Modbus Addr (Hexadecimal)	Modbus Addr (Decimal)	Description
0x0~1F3	0~499	User command
0x1F4	500	High Byte
		Low Byte
0x1F5	501	Reserved
		Auto Polling function <sup>(2)</sup>

0x1F6	502	High Byte	Low Byte
		The index of trigger command <sup>(3)</sup>	Output Trigger function <sup>(3)</sup>
0x1F7~1F9	503~505	Reserved	
0x1FA~76B	506~1899	Reserved (For Module Configuration)	
0x76C	1900	High Byte	Low Byte
		Reserved	Channel selection in through mode
0x76D	1901	Send data length in through mode	
0x76E~7FB	1902~2043	Send data in through mode	

NOTE 1 : When write the value greater than zero, the module will clear module request count, module response count, module error count, module error status and set module error command index to 255. To complete reset procedure, user has to write 0 to this field.

NOTE 2 : When set the value to be 1, the module will execute all HART polling commands automatically.

NOTE 3 : If change the value, the module will refer to the index value (0~99, 255 is for through mode) of trigger command to execute the corresponding user command. Ex: If the index of trigger command is 0 and the output trigger function value is 1, when change the value of output trigger function from 1 to 2, the module will execute the user command (index = 0).

## 4.3 Through Mode

In this mode, users can send and receive the HART command directly. Please refer to the below steps.

**Step 1** : Set the Channel to 0. (Through Mode just support channel 0) [Address : 1900, Low Byte]

**Step 2** : Set the Send length [Address : 1901]

**Step 3** : Set the HART command data. [Address : 1902~2043]

Ex: 0xFF 0xFF 0xFF 0xFF 0xFF 0x02 0x80 0x00 0x00 0x82

**Step 4** : Set the Auto Polling to 0. (In this mode, Auto Polling function can not be enabled.) [Address : 501, Low Byte]

**Step 5** : Set the The index of trigger command to 255. [Address : 502, High Byte]

**Step 6** : Get the receive count from Receive count in through mode [Address : 1150, High Byte] and error count from Error count in through mode [Address : 1151, Low Byte].

**Step 7** : Change the Output Trigger function value. [Address : 502, Low Byte]

**Step 8** : Get the value of Receive count in through mode and Error count in through mode until one of them is different than the last value.

**Step 9** : If the Receive count in through mode is different than the last value, the user can get the receive length from Receive length in through mode and the user can get receive data from Receive data in through mode [Address : 1153 ~ ] according to receive data length. [Address : 1152]

(If the Error count in through mode is different than the last value, it means it can not receive any data.)

## 5. Utility

### 5.1 .NET Framework Installation

The Utility for HRT-711 needs .NET Framework to run. The version of .NET Framework to execute Utility has to be greater than 2.0. If users do not have this, please ignore this section and jump to section 5.2.

Microsoft .NET Framework Version 2.0 :

<http://www.microsoft.com/downloads/details.aspx?FamilyID=0856eacb-4362-4b0d-8edd-aa b15c5e04f5&DisplayLang=en>

The .NET Framework install steps are shown in the below :

**Step 1 :** Press the Next button.

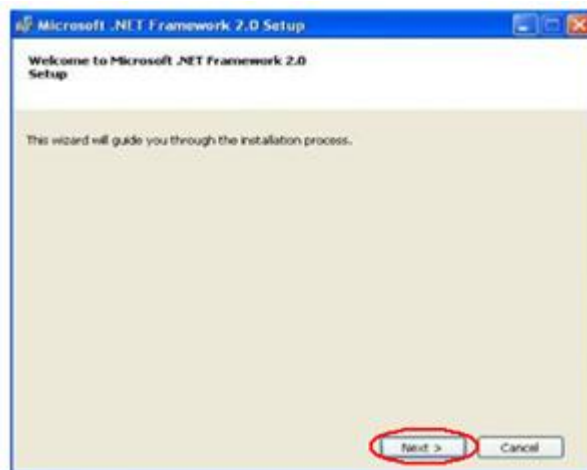

**Step 2 :** Check the “I accept the terms of the License Agreement” and click Install button.



**Step 3** : After finishing the installation, press Finish button to exit.





## 5.2 Install HRT-711 Utility

**Step 1** : Download the installation file of HRT-711 Utility from the CD-ROM disk (CD:\hart\gateway\hrt-711\utilities\) or the web site

([ftp://ftp.icpdas.com.tw/pub/cd/fieldbus\\_cd/hart/gateway/hrt-711/utilities/](ftp://ftp.icpdas.com.tw/pub/cd/fieldbus_cd/hart/gateway/hrt-711/utilities/))

**Step 2** : Execute the HRT-711 Utility x.x.x.x.exe (x.x.x.x is the version of the install package) file to install the Utility, and then click Next button.

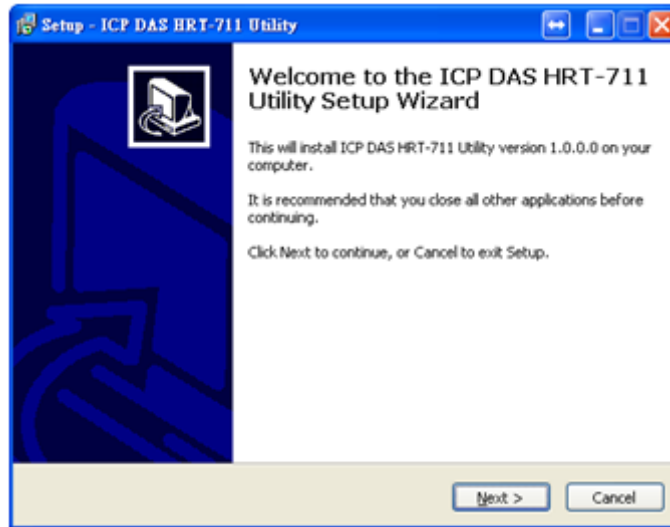

**Step 3** : Click the Next button to continue. If you want to change the installation destination, click Browse button to select the installation path.

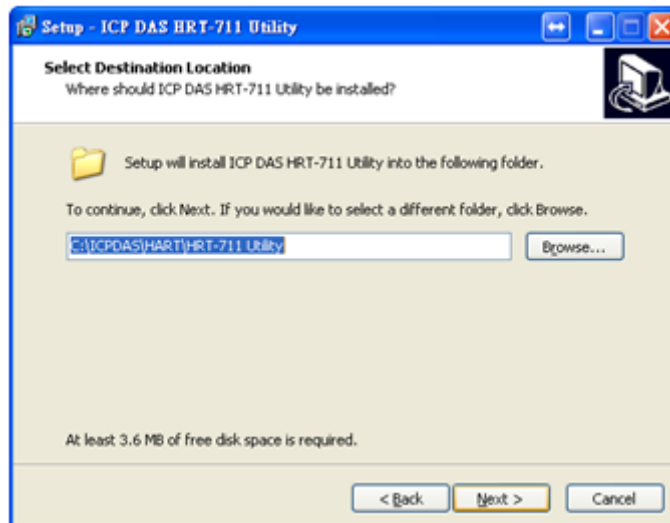

**Step 4 :** Choose the name and the path to install in the Start Menu, and then click Next.

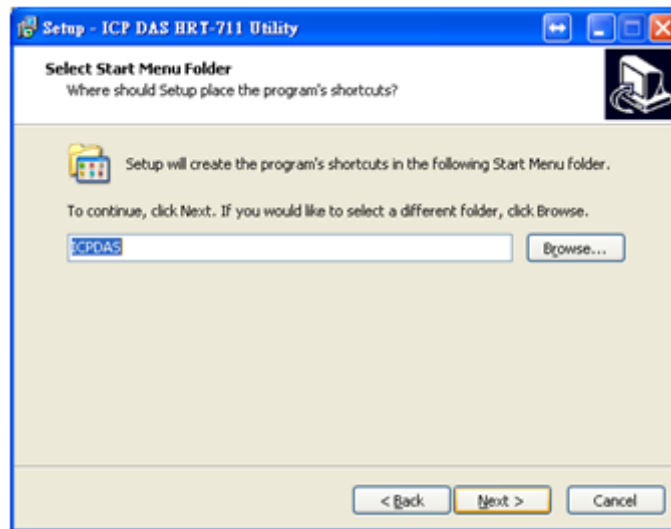

**Step 5 :** Click Install to start installation

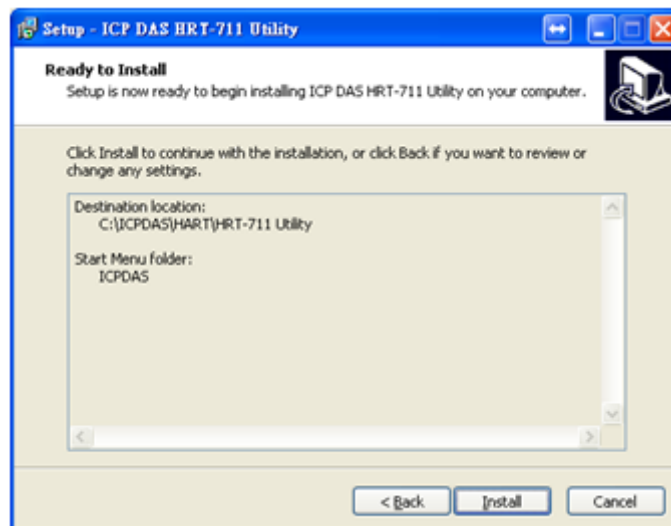

**Step 6 :** Wait the installation finish, then check “View Patch Note.txt” if you want and click Finish to complete the installation.

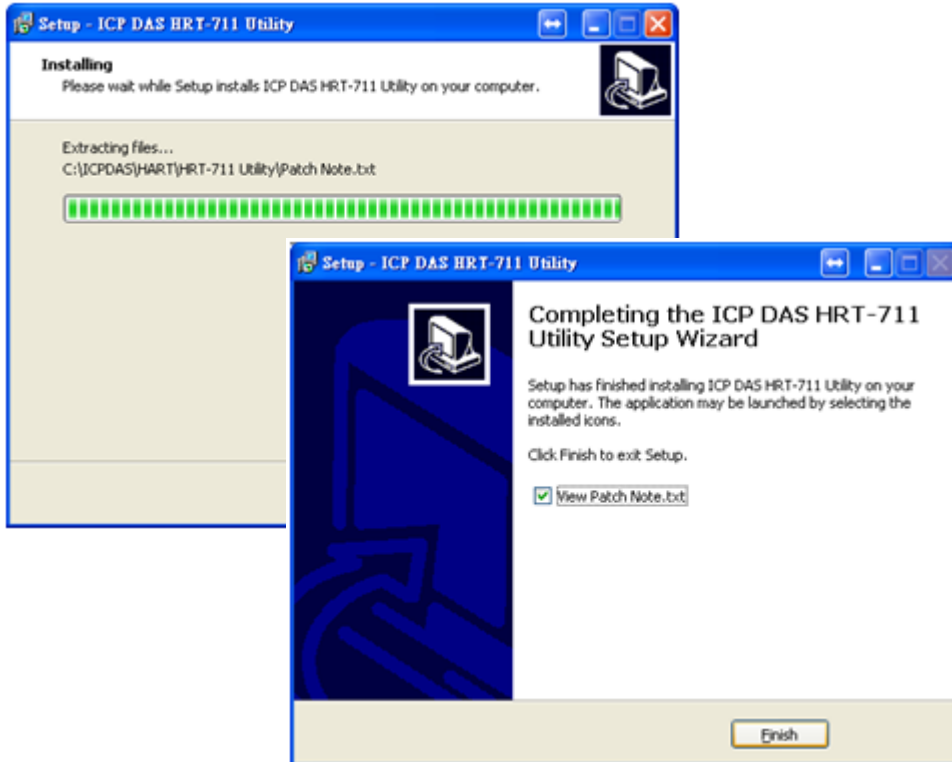

**Step 7 :** Users can execute the Utility in the following path.

**Windows XP**

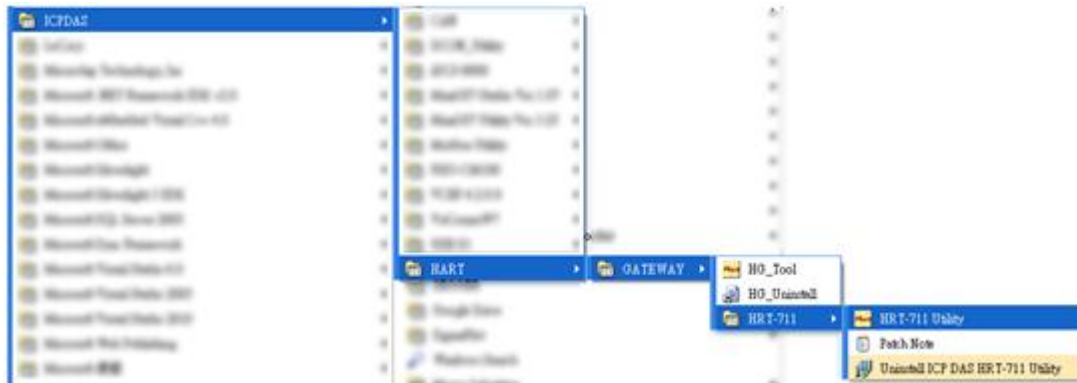

**Windows 7**

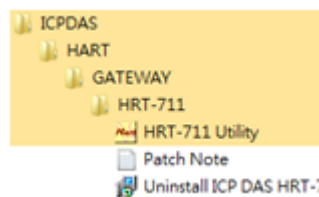

## 5.3 Introduction of Utility

The HRT-711 has, Ethernet and HART, two interfaces. The Utility can configure these two interfaces. Users have to choose which interface to configure in the first form of the Utility. User can click the figure to choose interface. The detail of the configuration of these two interfaces will be discuss in the following section.

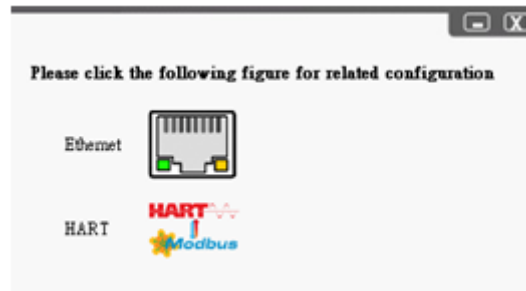

## 5.4 Configuration of Ethernet

The Ethernet interface of HRT-711 handles the Modbus/TCP and Modbus/UDP protocol. Users have to configure the interface for appropriate configuration (IP, Sub-net mask...etc) for using. Click Search Servers in this form to search all ICPDAS devices.

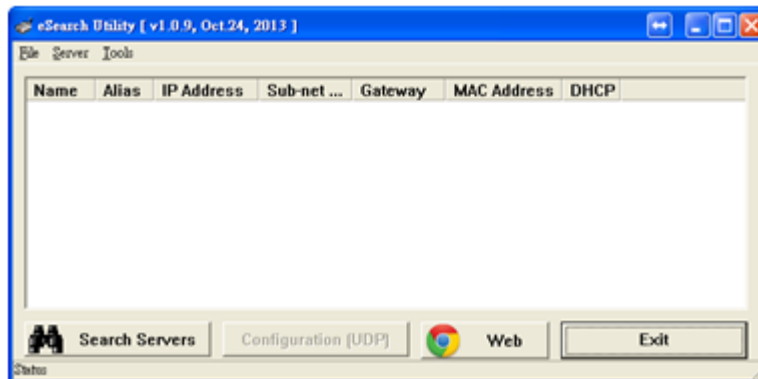

The HRT-711 will list in this form after searching. If the HRT-711 does not list in this form, please check the network connection or the power of the HRT-711.

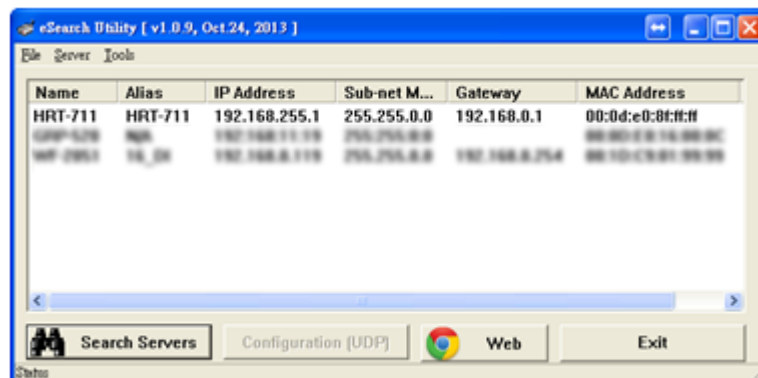

Users can configure the network parameters by double clicking HRT-711 in the list. Users can modify the parameters to appropriate setting for users' application, then click OK button to apply the new setting.



After assigning parameter, user can click Exit to exit the Network Configuration form.

## 5.5 Configuration of Modbus to HART

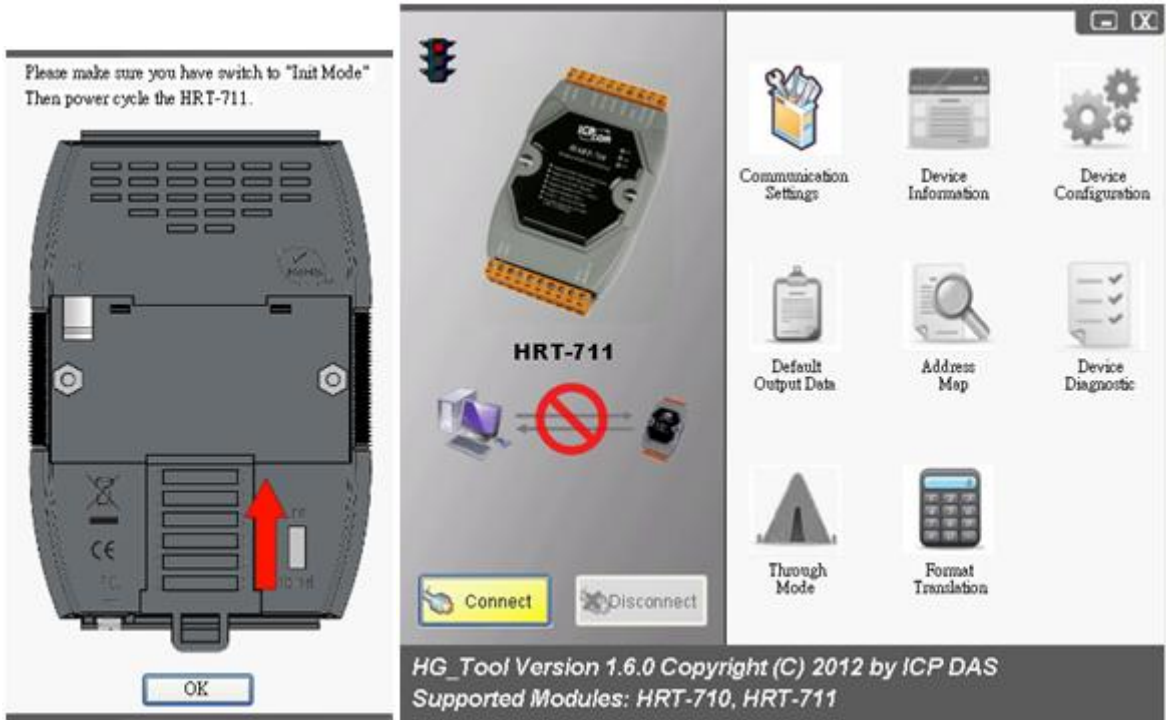

The HRT-711 is the Modbus/TCP and Modbus/UDP to HART gateway. It not only has to configure the Ethernet but also the HART interface.

NOTE : Before configuring HART interface, users have to switch the Init Mode switch to Init then power cycle the HRT-711.



The HART configuration form can divide into 5 parts. These 5 parts are Traffic Light, Current Config Module Name, Connection Status, Connection Control and Tools. The following section will describe each part and functionalities.



### 5.5.1 Traffic Light

Sign	Status
	The Com port of PC has not opened yet
	The Com port of PC has opened and tried to connect to the module
	The PC connects to module successfully



### 5.5.2 Current Config Module Name

The Current Config Module Name displays the current module name to configure. This Utility also supports HRT-711. So, the Current Config Module Name helps users to know what module is under configuring.

### 5.5.3 Connection Status

Figure	Status
	The Com port of PC has not opened
	The Com port of PC has opened and tried to connect to the module
	The PC connects to the module successfully







### 5.5.4 Connection Control

Button	Function
	When clicks this button, the PC will open the Com port and try to connect to the module.
	When clicks this button, the PC will break the connection of the module and close the Com port.

### 5.5.5 Tools

The Utility contains many tools for configuration and debug. The following table lists all tools and its functionalities.

Tool	Functionality
	Communication Setting The Com Port setting for the PC

Tool	Functionality
 <p>Device Information</p>	<p>Device Information Display the configuration of the device</p>
 <p>Device Configuration</p>	<p>Device Configuration Change the configuration</p>
 <p>Default Output Data</p>	<p>Default Output Data The configuration for boot-up default output of User CMD</p>
 <p>Address Map</p>	<p>Address Map Display the Modbus Address mapping of User CMD</p>
 <p>Device Diagnostic</p>	<p>Device Diagnostic Display current status of HART command of the module</p>
 <p>Through Mode</p>	<p>Through Mode Send/Receive the HART command</p>
 <p>Format Translation</p>	<p>Format Translation Translate Packed ASCII and IEEE 754 format</p>

### 5.5.5.1 Communication Settings

User can choose what device to configure. In this manual, please select HRT-711 in the dropdown list, and then select the Com Port number connected to HRT-711.

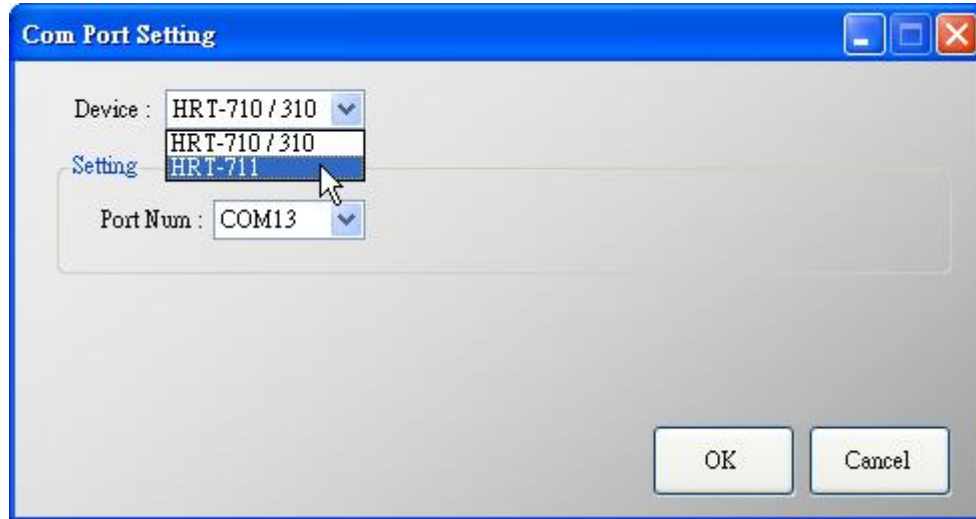

### 5.5.5.2 Device Information

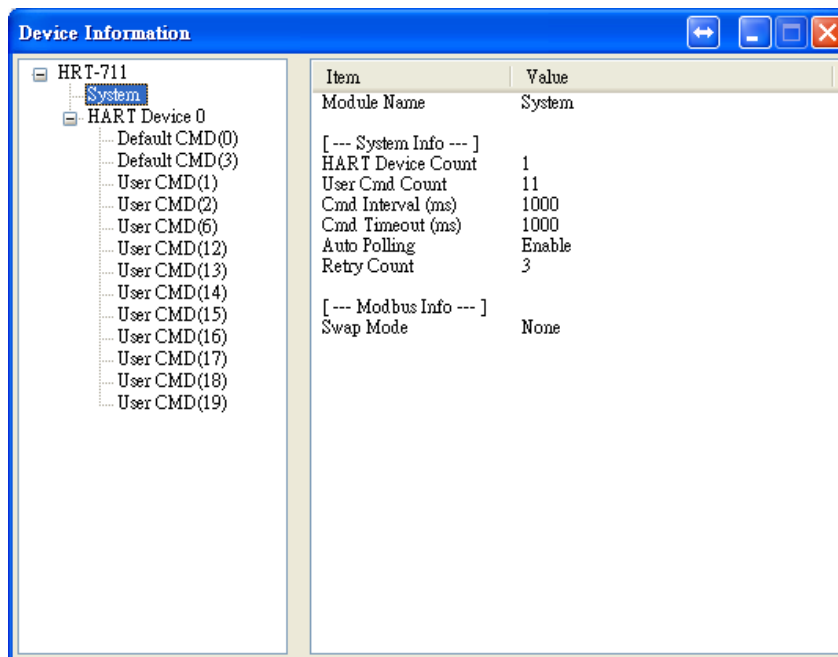

It shows the configuration of the module. When clicking the left item, it will show the item data in the right side. About the data of these items is shown as following table.

Node	Mouse	Behavior
HRT-711	Left Click	Display configuration
System	Left Click	Display configuration
	Right Click <sup>(1)</sup>	Generate Pop-up menu Basic Operation and Advanced



Node	Mouse	Behavior
		Operation
HART Device N	Left Click	Display configuration
Default CMD (N)	Left Click	Display configuration
	Right Click <sup>(2)</sup>	Generate Pop-up menu Basic Operation and Advanced Operation
User CMD (N)	Left Click	Display configuration
	Right Click <sup>(2)</sup>	Generate Pop-up menu Basic Operation and Advanced Operation

(1) When right clicking the item of System, it will generate a pop-up menu. The functionalities of the menu will describe below :

■ Basic Operation

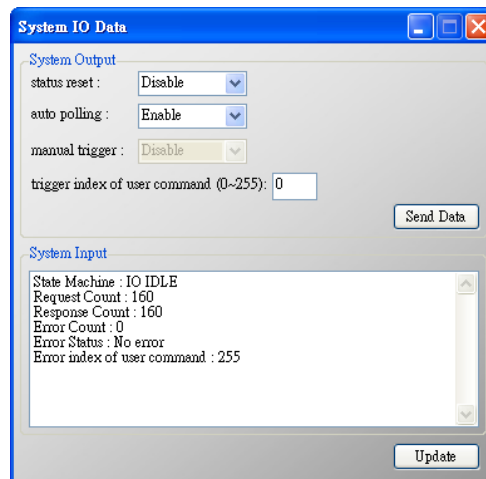

System Output	
status reset	When set the item to Enable, the module will clear module request count, module response count, module error count, module error status and set module error command index to 255
auto polling	When set the item to Enable, the module will execute all HART polling commands automatically
manual trigger	When set the item to Enable, the module will execute the user command once according to the value of trigger index of user command field
trigger index of user command	If users want to execute user command by manual mode, users must set the index value first
Send Data button	When click the button, it will update data in the System Output area to module
System Input	

System Output	
State Machine	It will show the state machine of module
Request Count	It will show the request count of HART UserCmd
Response Count	It will show the response count of HART UserCmd
Error Count	It will show the response error count of HART UserCmd
Error Status	It will show the error status of HART UserCmd
Error index of user command	It will show the latest HART UserCmd that has error happened. If the index value is 255, it means no error happened
Update button	When click the button, it will update System Input data from the module

### ■ Advanced Operation



Output Data
It has 6 bytes data. When click the Send Data button, it will send the output data to module. (Modbus Address: 500~502 in Output Data Area)
Input Data
It has 6 bytes data. When click the Update button, it will update the data from module. (Modbus Address: 500~502 in Input Data Area)

(2) When right clicking the item of Default or User CMD, it will generate a pop-up menu. The functionalities of the menu will describe below :

### ■ Basic Operation

In this function, only supports HART command 0, 1, 2, 3, 6, 11, 12, 13, 14, 15, 16, 17, 18, 19 and the different HART command will show the different user command

window (EX: The window of HART command 0 and 6 is shown as below).

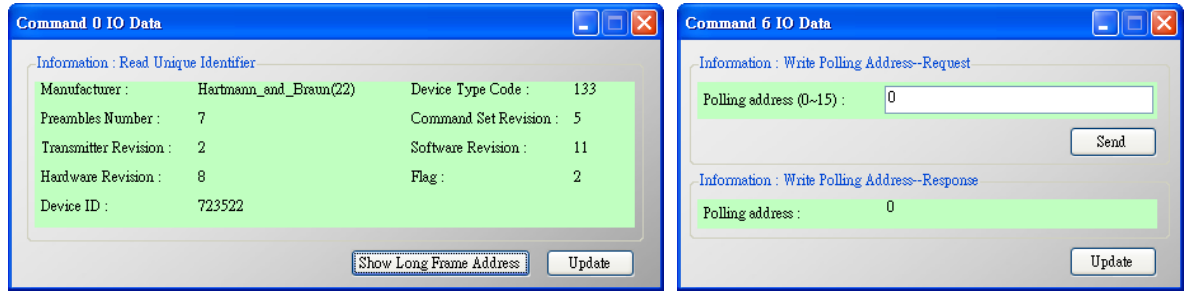

■ Advanced Operation

Users can write/read HART command/response via this form. In this form, there are two buttons Send Data and Update. When click the Send Data button, it will send the output data to the module. And when click this button, it will update the input and output data from the module.

NOTE : About the Input data area of user command, the first 2 bytes are response code1 and code2 of HART command and the left bytes are the HART command data.

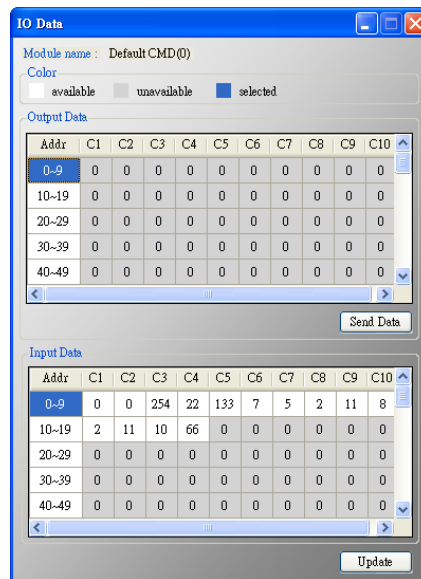

### 5.5.5.3 Device Configuration

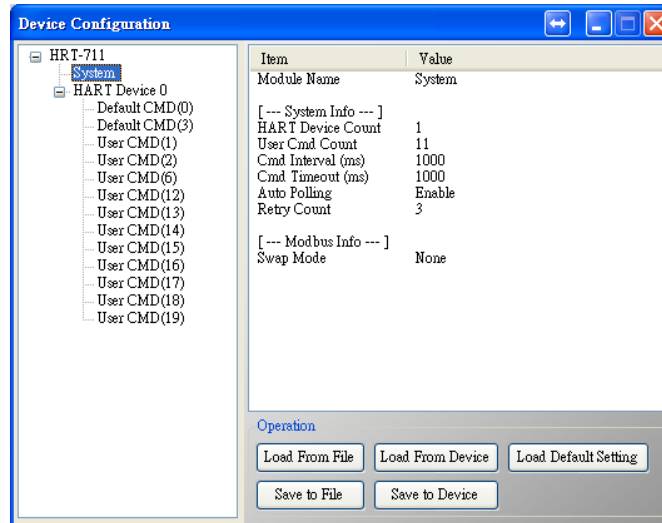

It will show the system configuration of HRT-711 and users can also configure HRT-711 here. When clicking the left items, it will show the corresponding item information in the right side of window. The following is detailed description.

Node	Mouse	Behavior
HRT-711	Left Click	Display configuration
System	Left Click	Display configuration
	Right Click <sup>(1)</sup>	Generate Pop-up menu Edit and Add Module
HART Device N	Left Click	Display configuration
Default CMD (N)	Left Click	Display configuration
	Right Click <sup>(2)</sup>	Generate Pop-up menu Edit Delete and Add Command
User CMD (N)	Left Click	Display configuration
	Right Click <sup>(3)</sup>	Generate Pop-up menu Edit and Delete

(1) When right clicking the item of System, it will generate a pop-up menu. The functionalities of the menu will describe below :

■ Edit

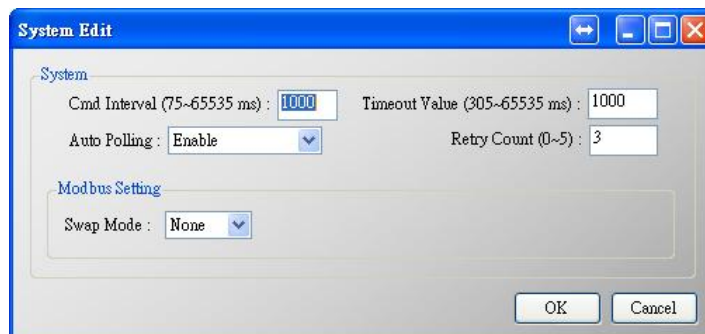

It is used to set the communicating parameters of HART and Modbus and described as below.

System											
Cmd Interval	The polling interval of HART Cmd										
Timeout Value	The timeout value of HART Cmd.										
Auto Polling	If the function is enabled, the HRT-711 will execute all HART polling Cmd automatically.										
Retry Count	When HART comm. error happened, the HRT-711 will re-send the HART Cmd for Retry count times.										
Modbus Setting											
Swap Mode	<p>It is used for the format of the word data in Modbus. The option are None / Byte / Word / W&amp;B.</p> <p>Ex : 2 words data (0x1234, 0x5678) from HRT-711. Users can set the swap mode for different data format.</p> <table border="1" style="margin-left: auto; margin-right: auto;"> <thead> <tr> <th>Swap Mode</th> <th>Data</th> </tr> </thead> <tbody> <tr> <td>None</td> <td>0x1234 0x5678</td> </tr> <tr> <td>Byte</td> <td>0x3412 0x7856</td> </tr> <tr> <td>Word</td> <td>0x5678 0x1234</td> </tr> <tr> <td>W&amp;B</td> <td>0x7856 0x3412</td> </tr> </tbody> </table>	Swap Mode	Data	None	0x1234 0x5678	Byte	0x3412 0x7856	Word	0x5678 0x1234	W&B	0x7856 0x3412
Swap Mode	Data										
None	0x1234 0x5678										
Byte	0x3412 0x7856										
Word	0x5678 0x1234										
W&B	0x7856 0x3412										

■ Add Module

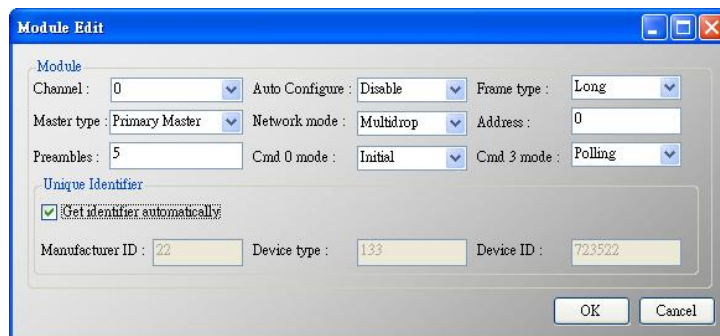

It is used to set the communicating mode for HART devices and described as below.

Module	
Channel	0~7. (Only channel 0 supports now)
Auto Configure	If enables this function, the HRT-711 will detect the frame type, address, preambles, manufacturer ID, device type and device ID of

	HART device automatically Warning : If enables this function, just supports HART Point to Point mode
Frame type	Short or Long frame
Master type	Primary or Secondary Master Warning : In general, the HRT-711 should set to the Primary Master
Network mode	Point to Point or Multi-drop mode. Point to Point : Only one HART slave device in HART bus Multi-drop : More than one HART devices can be in HART bus
Address	0~15 ° Warning : If the address of HART device is 0, it means in Point to Point mode
Preambles	5~20
Cmd 0 Mdoe	Disable(1) / Initial(2) / Polling(3)
Cmd 3 Mdoe	Disable(1) / Initial(2) / Polling(3)
<b>Unique Identifier</b>	
Auto Get Unique ID	If the frame type of HART slave device is long frame, users can enable this function to get unique ID automatically by short frame address
Manufacturer ID	Users can set the manufacturer ID for HART device. If the frame type is short, users can omit this setting
Device Type	Users can set the device type for HART device. If the frame type is short, users can omit this setting
Device ID	Users can set the device ID for HART device. If the fram type is short,users can omit this setting

1. Disable : The HRT-711 will not execute the default HART Cmd
  2. Initial : The HRT-711 will execute the default HART Cmd automatically when in Initial mode.
  3. Polling: The HRT-711 will execute the default HART Cmd automatically when in Operation mode.
- (2) When right clicking the item of HART Device N, it will generate a pop-up menu. The functionalities of the menu will describe below :

■ Edit

Same as the selection Add Command in the pop-up menu when right click System, please refer to that section.

■ Delete

Delete current selected module

■ Add Command

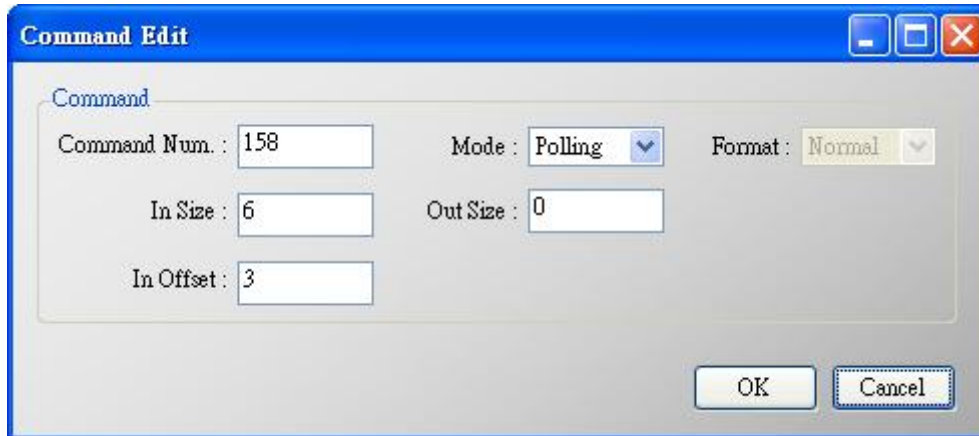

It is used to set the communicating parameter for HART User CMD. The details are described as below :

Command	
Command Num	Set the HART command number
Mode	Initial <sup>(1)</sup> / Polling <sup>(2)</sup> / Manual <sup>(3)</sup>
Format	Normal <sup>(4)</sup> / Simple <sup>(5)</sup> (Data exchange format between HART and Modbus)
In Size	Set the input data length of HART command. Note: The size includes 2 bytes response code and data size of HART command. (Ex: HART Cmd 0 = 2(response code) +12 =14)
Out Size	Set the output data length of HART command.
In Offset	Set the input offset of HART returned command data. <a href="#">(HG_Tool v1.5.0 or newer supported, refer to example FAQ26)</a>

1. Initial : The module will run this command in initial mode
2. Polling : The module will run this command in operation mode
3. Manual : The module will run this command by manual
4. Normal : When read / write HART data by Modbus, the data format is HART standard command format

5. Simple : When read / write HART data by Modbus, the data format is simple format defined by HRT-711. The detailed description, please refer to the Appendix B. (In this mode, the HMI or SCADA software can read or write HART data and don't need to process any data. Now, it is only supported HART command number: 1, 2 and 3.)

(3) When right clicking the item of User CMD (N), it will generate a pop-up menu. The functionalities of the menu will describe below :

■ Edit

Same as the selection Add Command in the pop-up menu when right click HART Device N, please refer to that section.

■ Delete

Delete current selected User CMD (N)

### 5.5.5.4 Default Output Data

It is used to set the default value for all UserCMD output data.

(1) Click the left User CMD item and if the output length of the User CMD is not zero, then the occupied address will be blue in the right window.

(2) Double click the address field and it will show the Data Edit window to set the default value.

When finished all configuration, click Save to Device button to apply all settings. (The module will reboot when click Save to Device button)

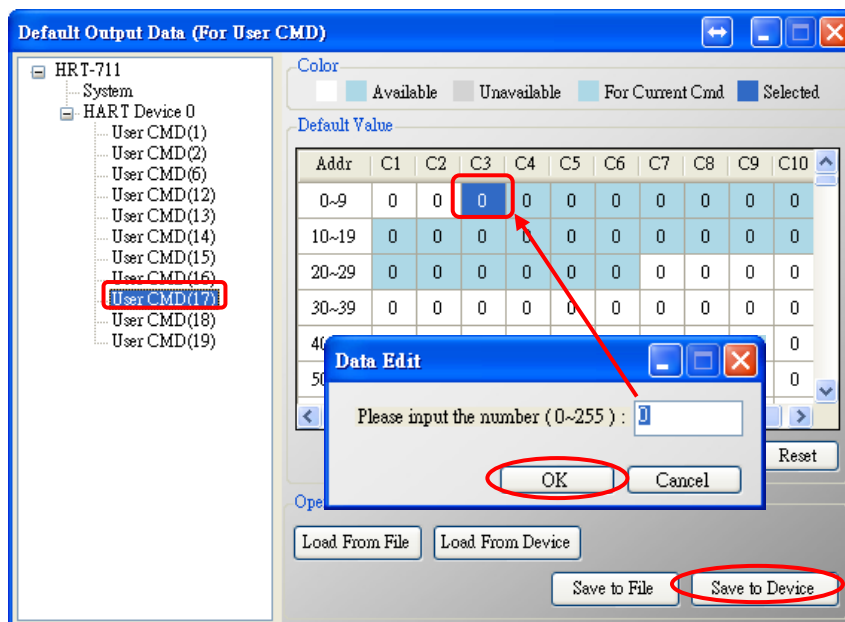



### 5.5.5.5 Address Map

It is used to show the MB address for all User CMD.

- (1) Click the left User CMD item and the occupied address of the User CMD will be blue in the right Modbus AO or Modbus AI table.
- (2) The data of Modbus AI table can be read by Modbus Function Code 4.
- (3) The data of Modbus AO table can be read by Modbus Function Code 3 and written by Modbus Function Code 6 or 16.



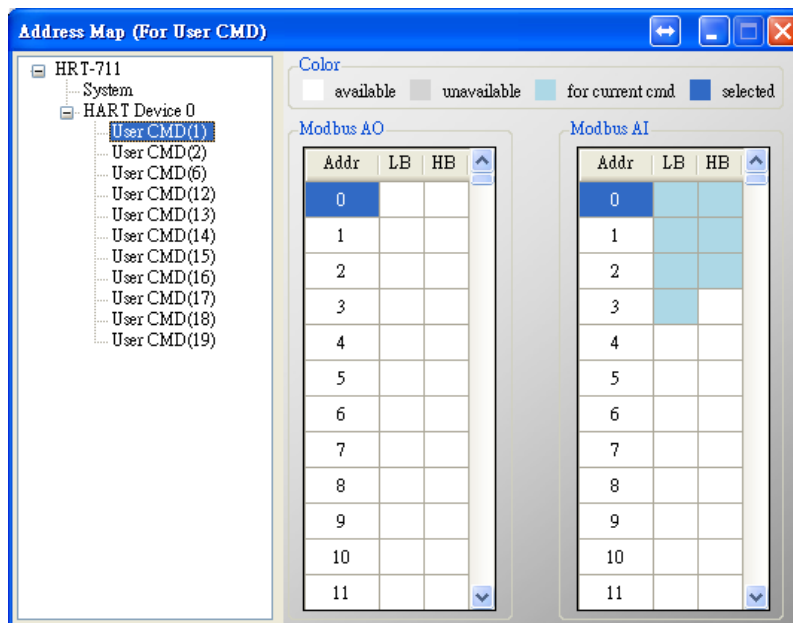

NOTE : The Modbus address of the default command is fixed, so users can refer to section 4.2 to get the address.



### 5.5.5.6 Device Diagnostic

It is used to show the status of HART command in the HRT-711.

- (1) Click the left User CMD item and the icon of the item will show the status described as below :

Figure	Status
	It means no error
	It means the command has never been executed
	It means the command has error and the error status shows at the right side of the window
	It means the item is selected

- (2) Status Update button : Refresh the status of HART Cmd
- (3) Record button : The HRT-711 records the latest error command and saves to Record 1~3. Users can get these records by click Record 1, Record 2 and Record 3 button.

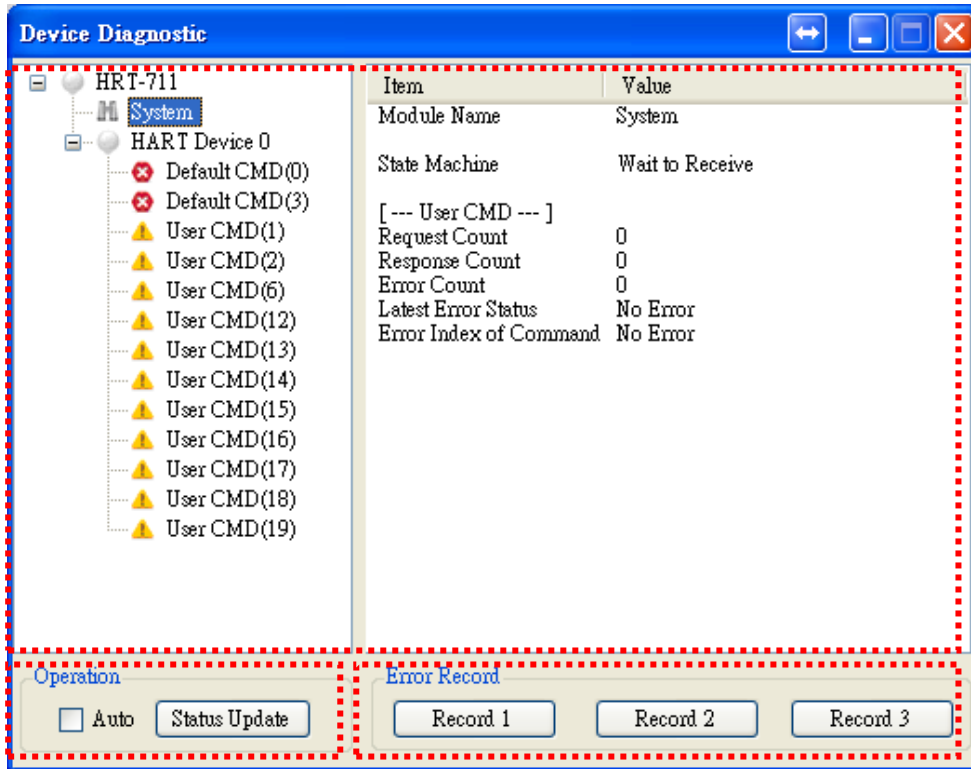

### 5.5.5.7 Through Mode

It is used to send / receive HART command directly. Users have to check the items below before using through mode function.

- (1) The RUN LED is always on.
- (2) The auto polling function is disabled.

Here is an example to send / receive HART command 0 :

**Step 1** In Send field, fill in the data“0xFF 0xFF 0xFF 0xFF 0xFF 0x02 0x80 0x00 0x00” and then click Send button to send HART Cmd.

**Step 2** Click Update button to show the response of HART device.

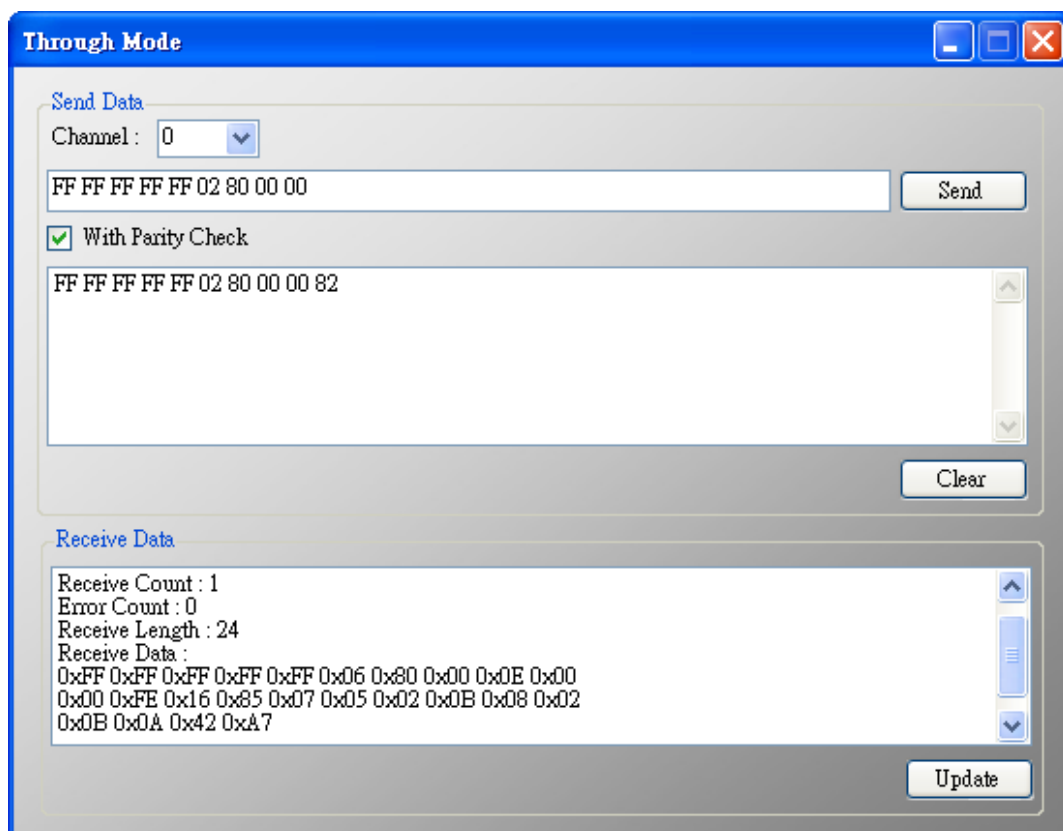

### 5.5.5.8 Format Translation

Here we provide some tools for HART communication. Packed ASCII Translate tool can convert Packed ASCII into ASCII format. IEEE754 Translate tool can convert IEEE754 into byte format.

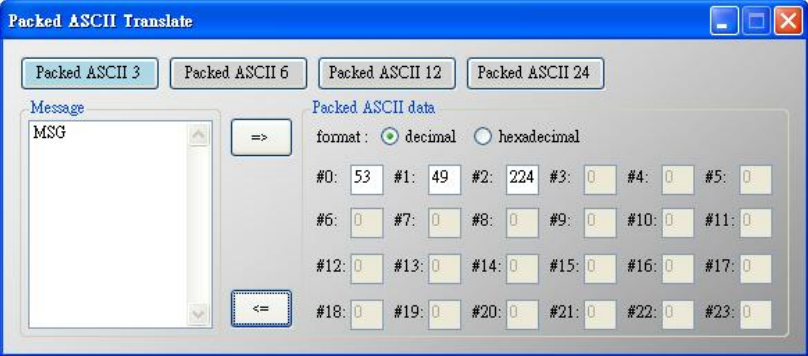
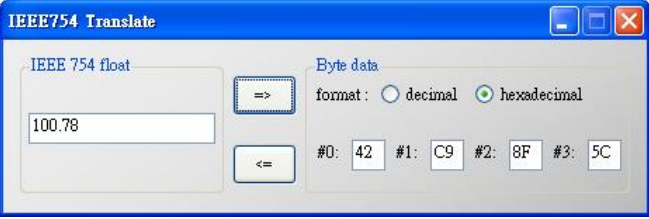
Features	Description
<p>Packed ASCII Translate</p>	<p>It can be used to convert between Packed ASCII and ASCII format</p> 
<p>IEEE 754 Translate</p>	<p>It can be used to convert between IEEE754 and DWORD format</p> 

## 6. FAQ

### Q01 : How to add HART devices to HRT-711 ?

1. Add first HART device: (Ex: Add ABB AS800 HART device)

[ Step 1 ] Connect to HRT-711 and use “HRT-711 Utility” to start configuration

(1) Select HART in the first page of the Utility and switch operation mode to Init.

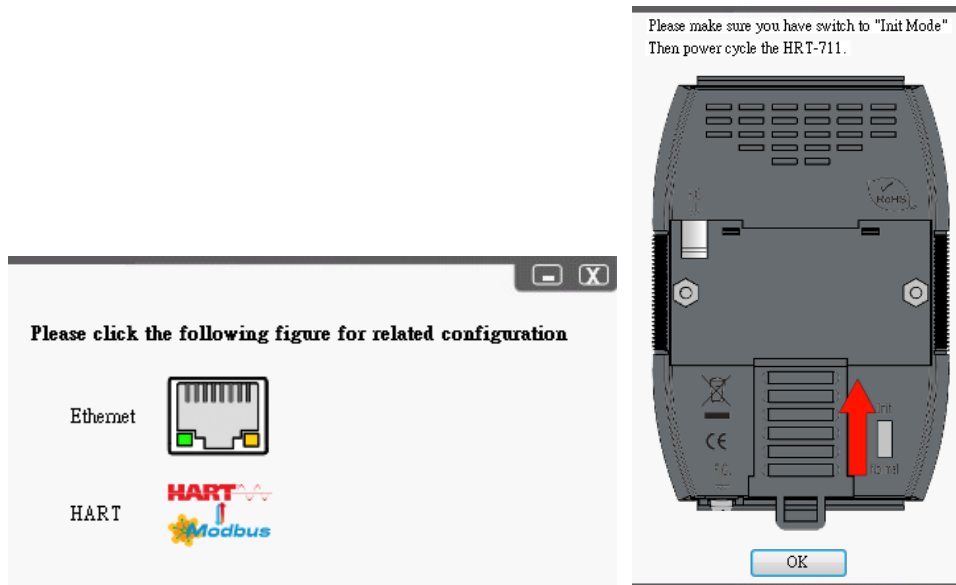

(2) Selecting device to HRT-711 and switching to appropriate com port in the Communication Setting, and then click OK

(3) Click the “Connect” button to connect HRT-711 module

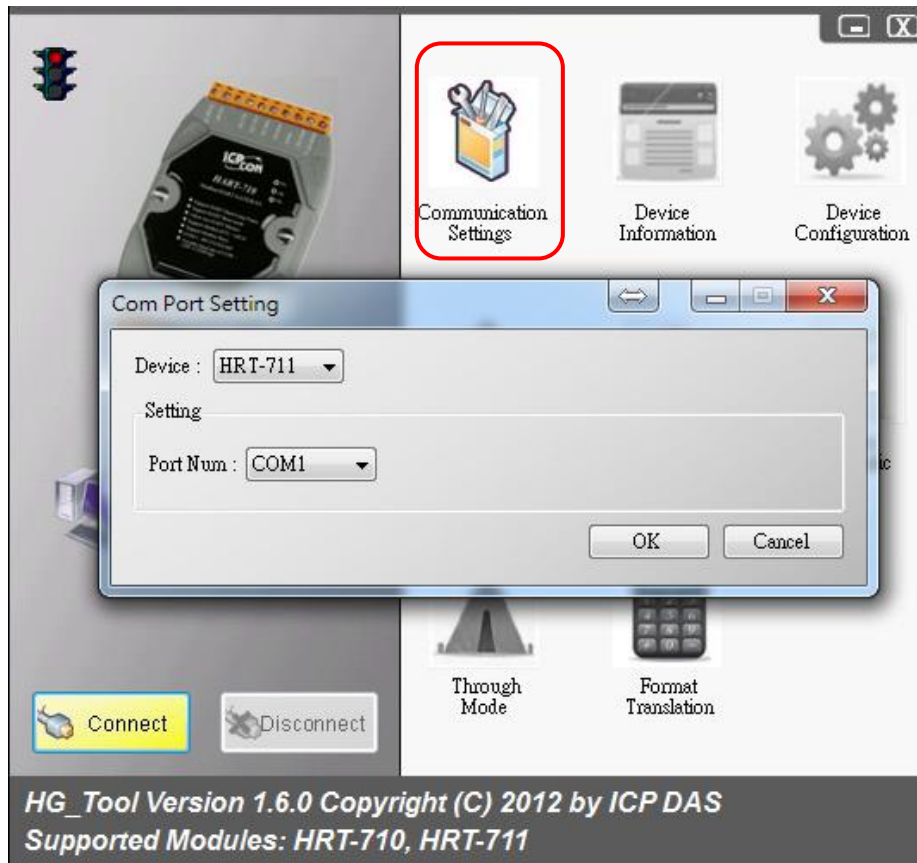

**[ Step 2 ]** Deleting the default HART device setting in HRT-711

Once successfully connected to HRT-711, the traffic light indicator will change to green (🚦) to indicate that the Utility can start configuring HRT-711. Now, users will need to delete the default configuration by clicking Device Configuration option on the right side of the Utility. Follow the figure below to delete the default configuration for preparing add a new HART device.

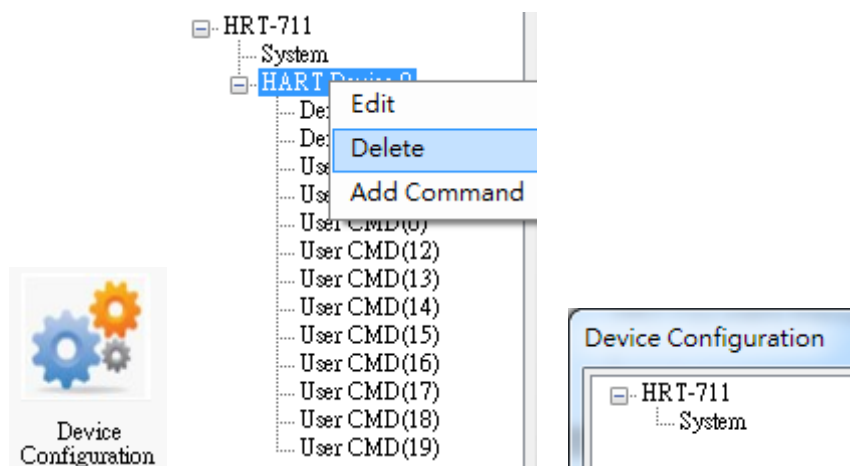

**[ Step 3 ]** Add the new HART device setting

Users can now adding new HART device by right clicking System item.

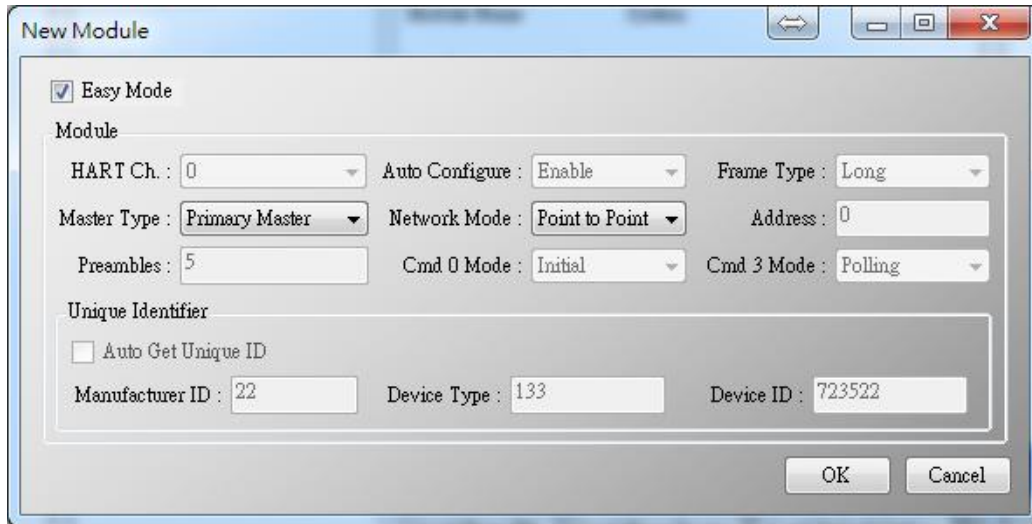
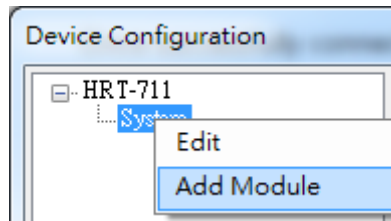

**[ Step 4 ]** Save the HART device setting to HRT-711

(1) Click the “Save to Device” button to save the new HART device setting to HRT-711

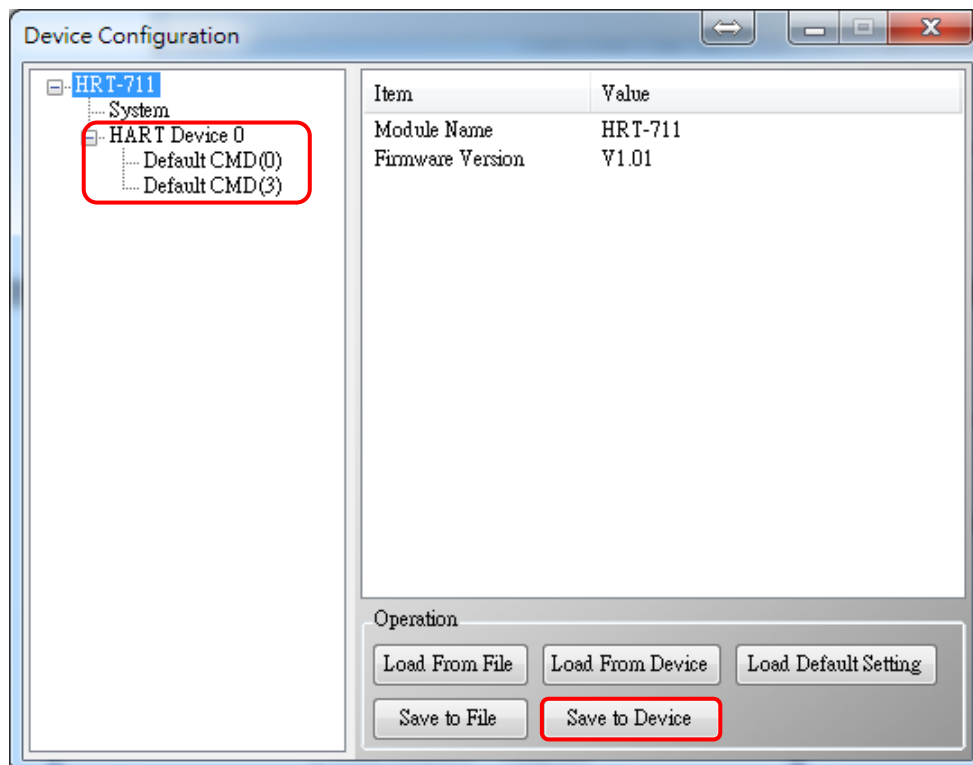

2. Add more than one HART devices : (Ex : Add ABB AS800 (Addr=2) and Foxboro I/A Pressure (Addr=1) HART devices)

[ Step 1 ] Follow the previous step to delete default configuration

[ Step 2 ] Add two new HART device setting

The following figures are the settings for these two HART devices.

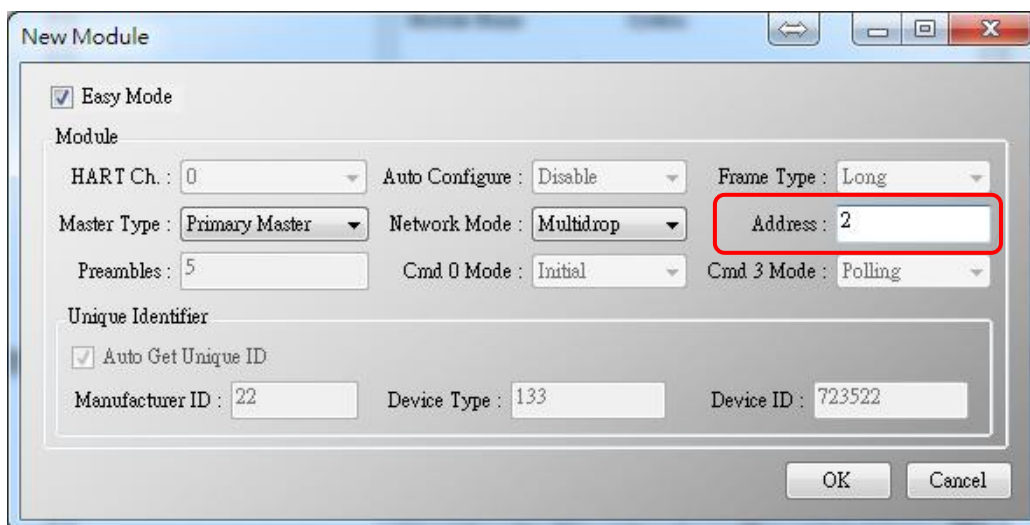
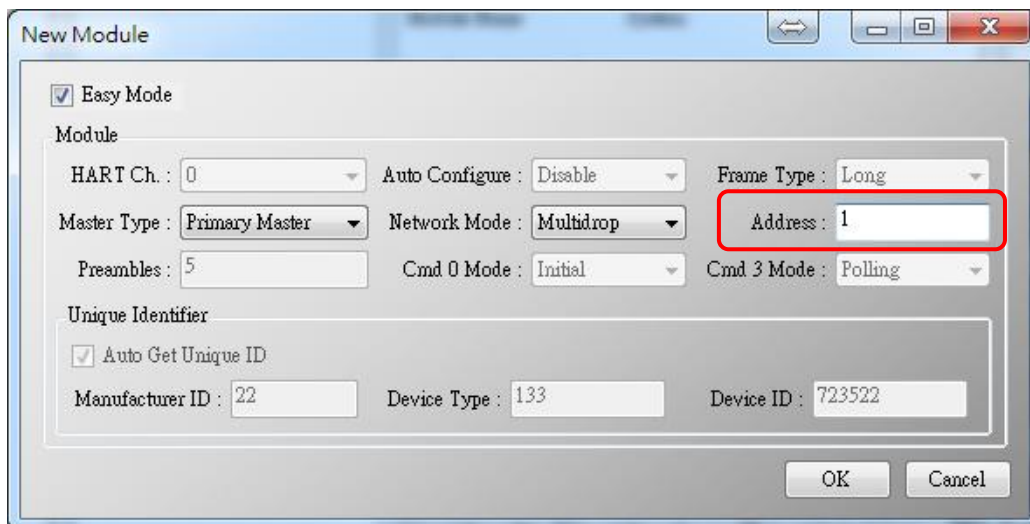

[ Step 3 ] Save the HART device setting to HRT-711

(1) Click the “Save to Device” button to save the new HART device setting to HRT-711



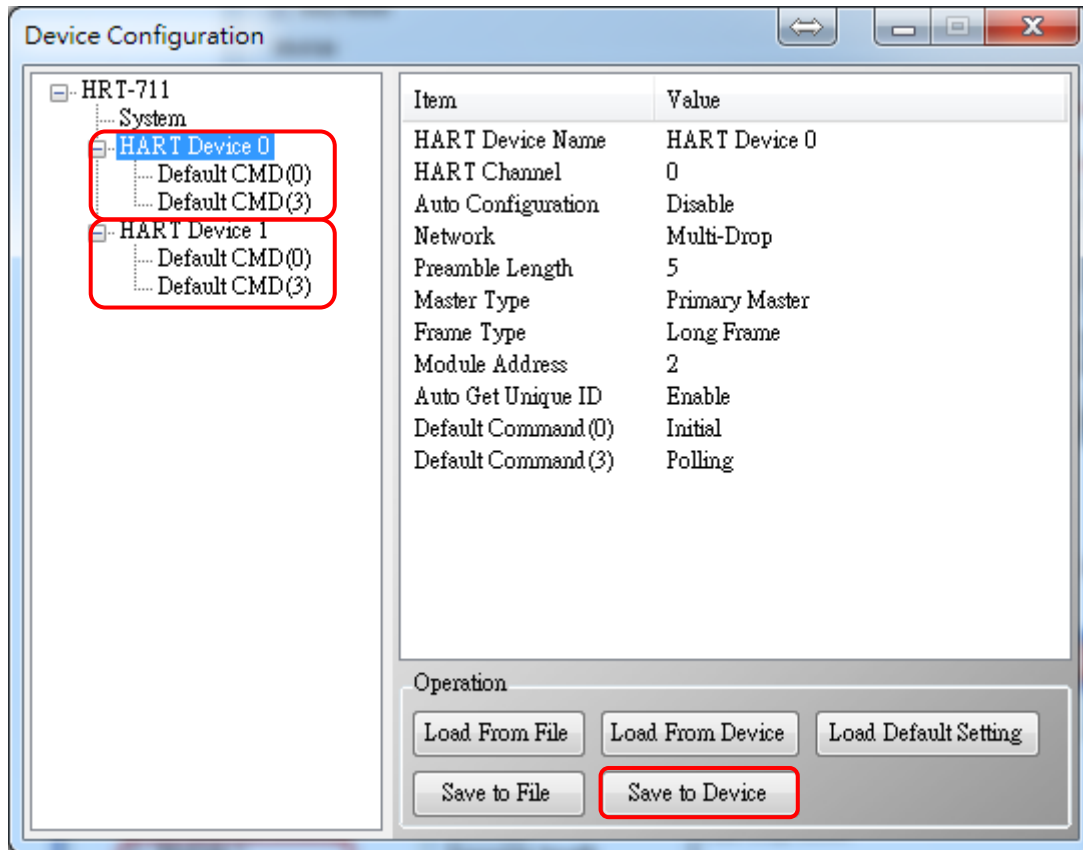

**Q02 : How to make sure that HRT-711 gets the HART device data correctly ?**

After adding HART device setting to HRT-711 module (refer to Q01), then users can follow the following steps.

(1) Make sure HRT-711 and Utility are well connected and then click “Device Information” button

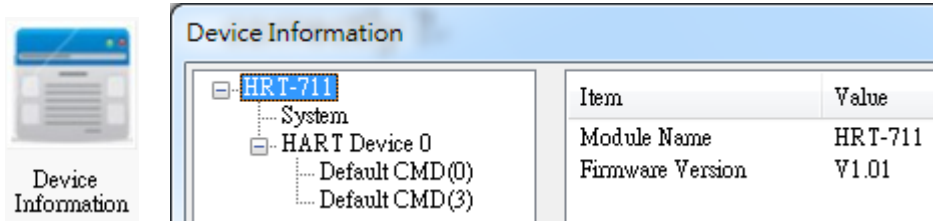

**[ Check I/O Data of the Default CMD(0) ]**

(2) Right click the button on the “Default CMD(0)” item and choose the “Basic operation” option to open the “I/O Data” screen of the “Default CMD(0)”

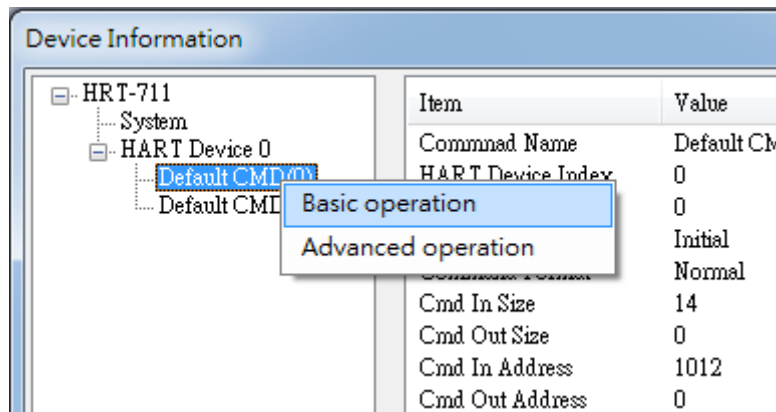

(3) The following figure shows I/O Data of the “Default CMD(0)” is OK and NG

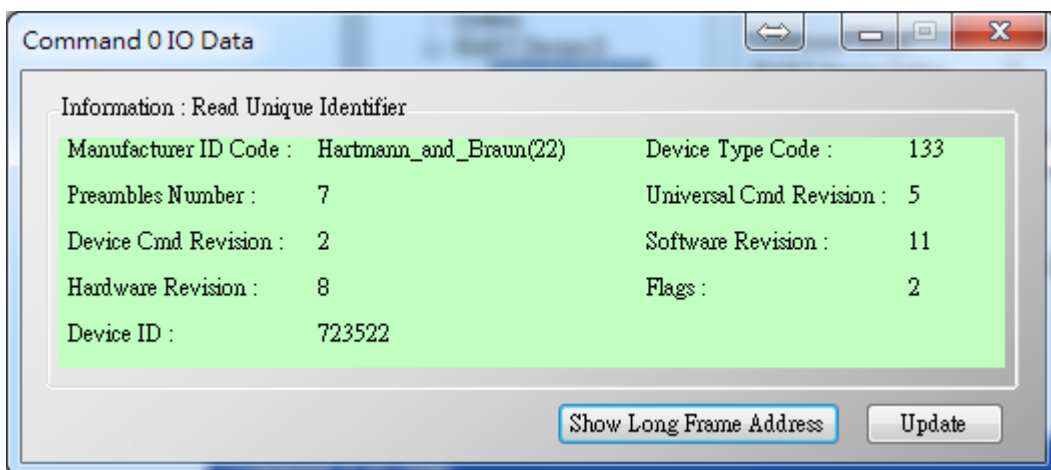

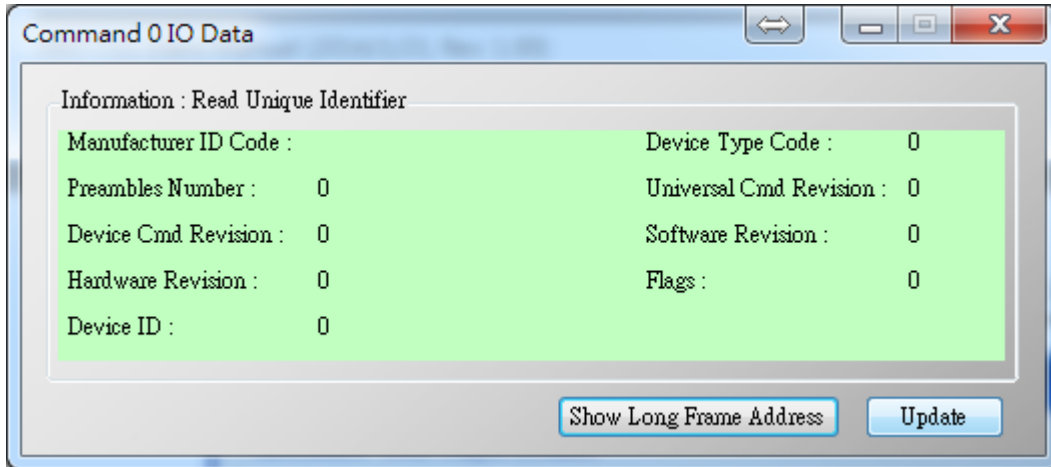

**[ Check I/O Data of the Default CMD(3) ]**

(4) Right click the button on the “Default CMD(3)” item and choose the “Basic operation” option to open the “I/O Data” screen of the “Default CMD(3)”

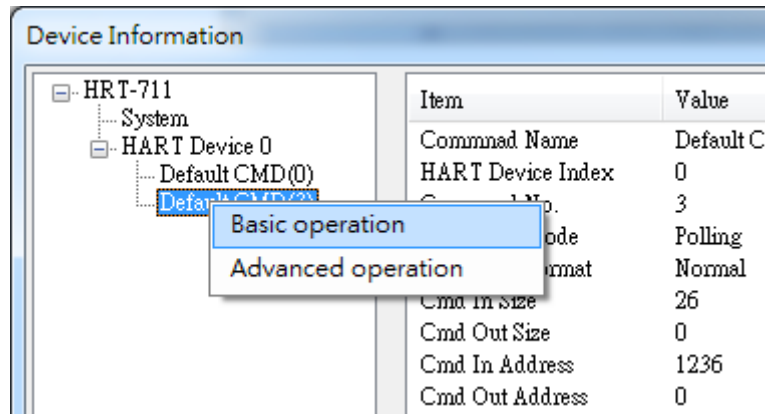

(5) The following figure shows I/O Data of the “Default CMD(3)” is OK and NG

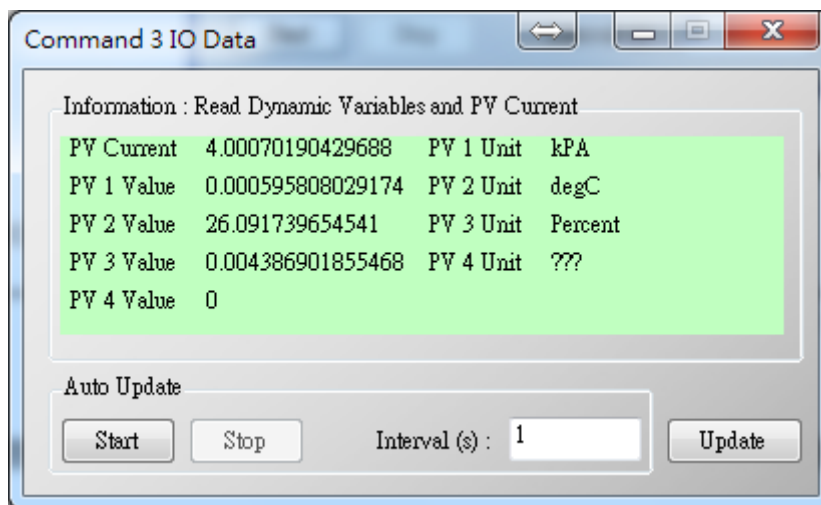

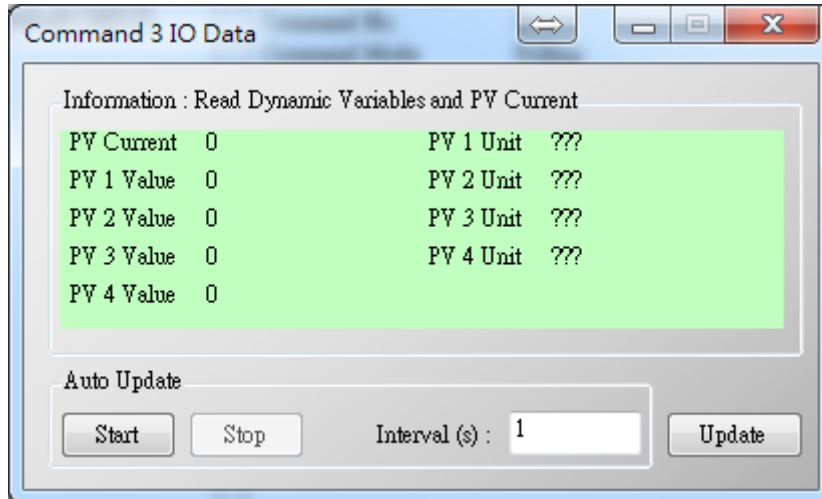

(6) After testing the I/O data of the “Default CMD(0)” and “Default CMD(3)” , when the result is ok, it means that the communication between HRT-711 and HART devices is ok.

### Q03 : How to map HART device CMD(3) data directly to SCADA or HMI ?

- (1) Make sure that the connection between HRT-711 and HART device is good. (Refer to Q02)
- (2) Set “Swap Mode” of system setting in HRT-711 to be “W&B”.

[1] In “Device Configuration” screen, right click the button of mouse on “System” item and click the “Edit” option to open “System Edit” screen like Figure 3-1

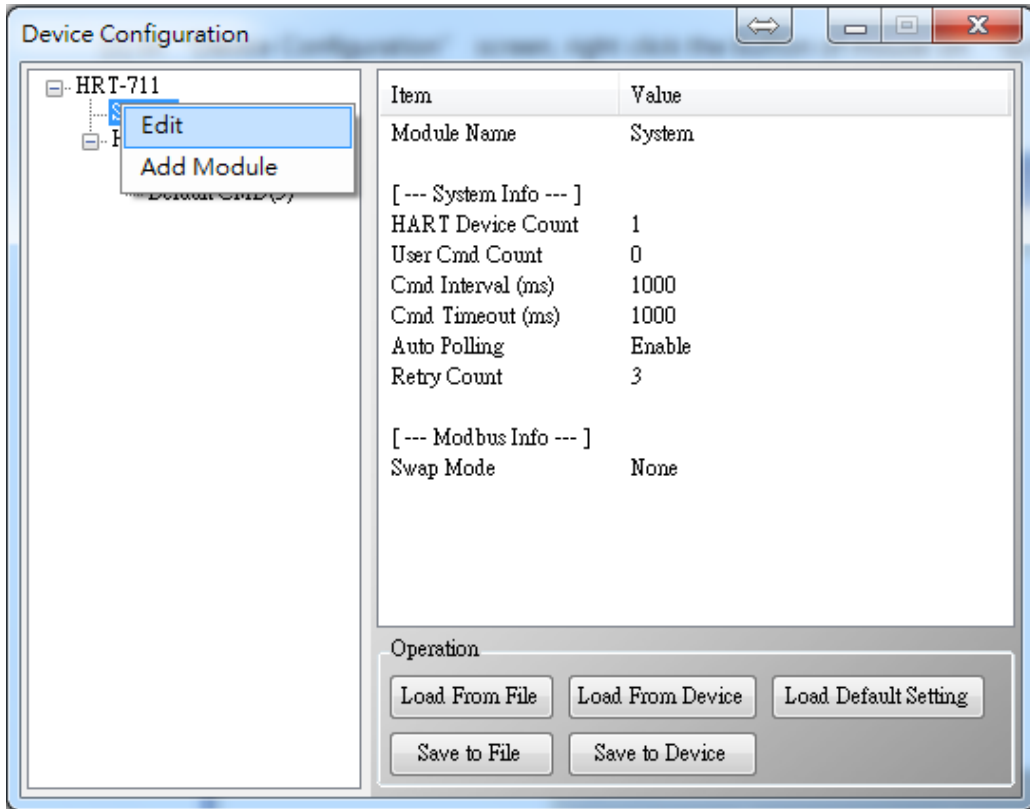

Figure 3-1 Open “System Edit” screen

[2] Set the “Swap mode” item to be “W&B” and click “OK” button like Figure 3-2

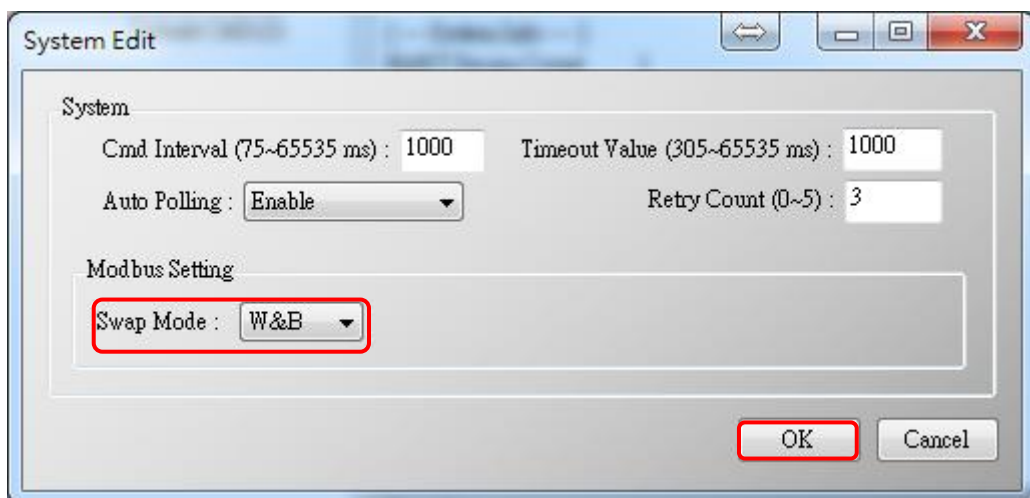
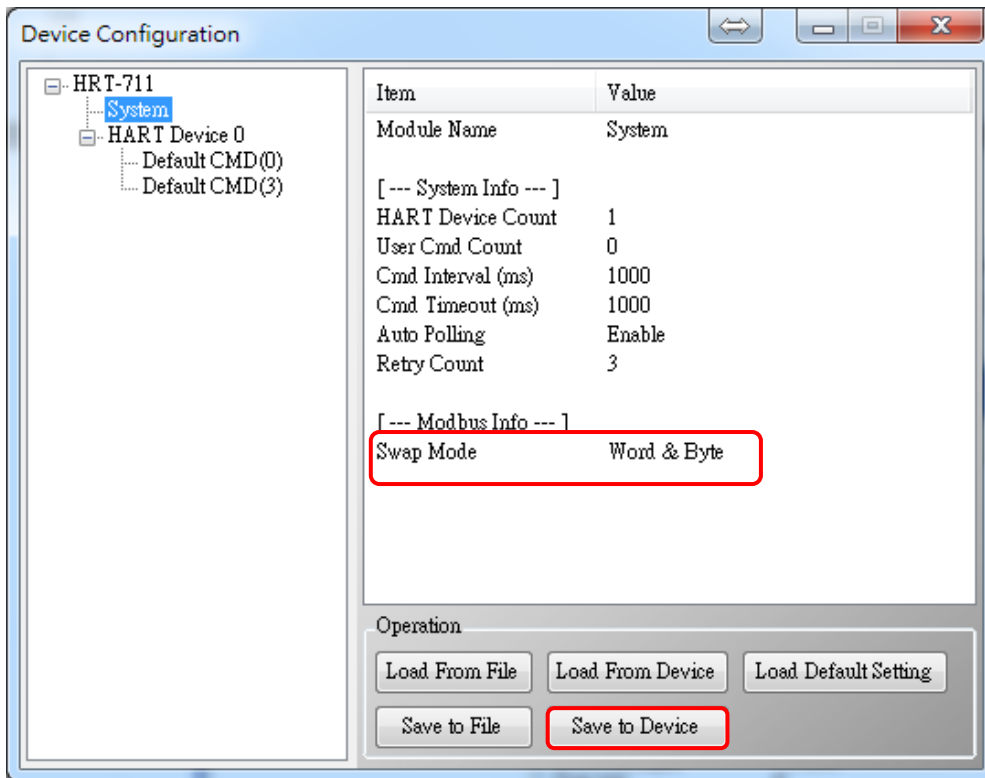

Figure 3-2 Set “Swap mode” to be “W&B”

[3] Click the “Save to Device” button to save the new system setting to HRT-711 like Figure 3-3



**Figure 3-3 “Save to Device” function**

(3) Read HART data by Modbus TCP from HRT-711.

[1] The HRT-711 provides the MB Address 1300 ~ 1459 (Default CMD(3)(S) Data for Module 0 ~ 15 in HRT-711 => The detailed information refers to the sector 4.3 of users’ manual) and users can map the CMD(3) data of HART device to SCADA directly with these Modbus address 1300 ~ 1459.

[2] For the “Default CMD(3)(S) data of Module 0” in HRT-711, the mapped MB address is 1300 ~ 1309. The below MB/RTU client will use the “Modscan” and “Modbus Poll” tool to show the CMD(3) data of HART device by polling Modbus address 1300 ~ 1309.

<1> Confirm the connection between Utility and HRT-711 is disconnected.

<2> Make sure the HRT-711 is in the Normal operation. ( Set the “Dip Switch” on the back of HRT-711 to be “Normal” and reboot HRT-711. )

<3> Set the “Display” mode to be “Float” format as Figure 3-4

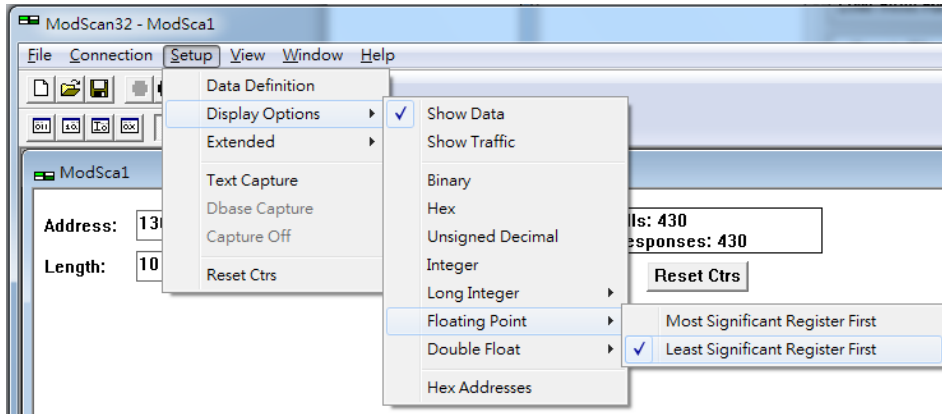

**Figure 3-4 Modbus display format**

<4> Fill the “IP Address” & “Port Number” and click “OK” button to connect to HRT-711, e.g. Figure 3-5

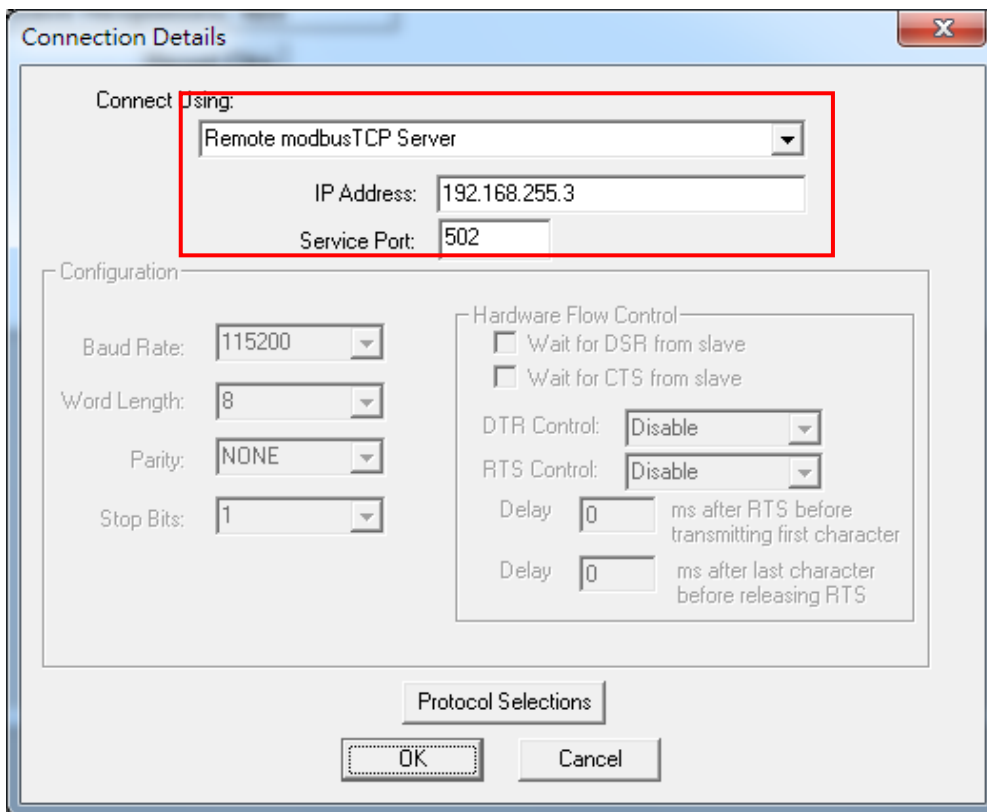

**Figure 3-5 Connection parameters**

<5> The CMD(3) data of HART device is successfully read, e.g. Figure 3-6

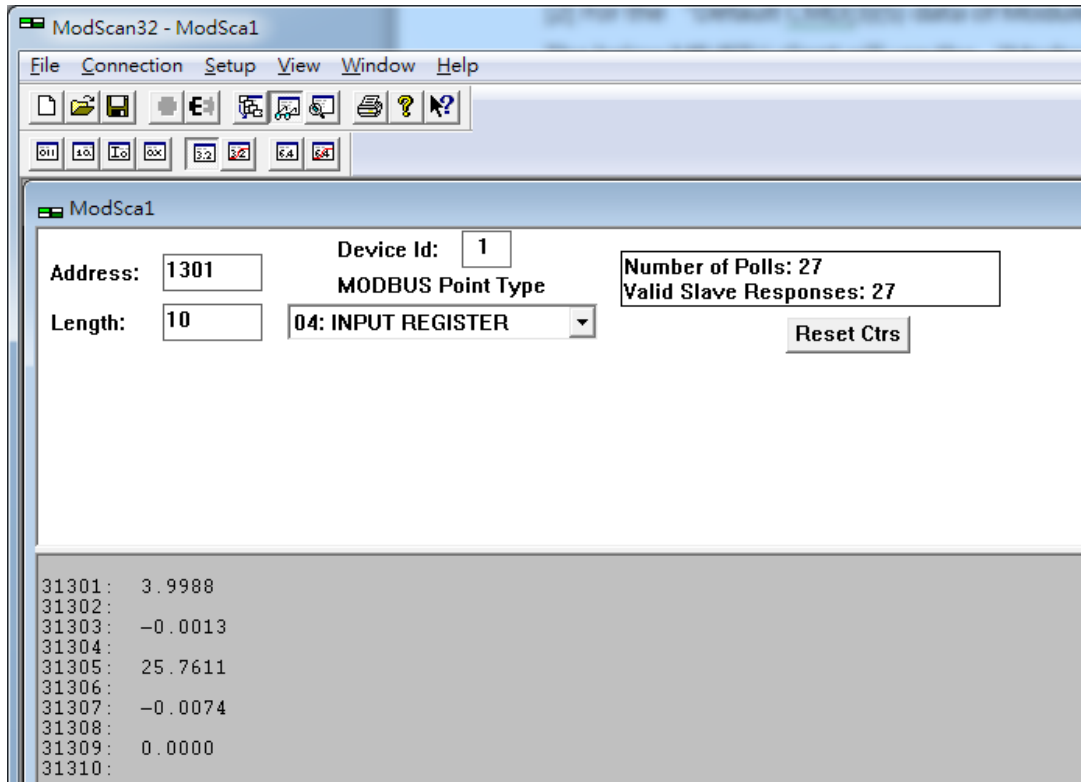

**Figure 3-6 The CMD(3) data of HART device**

[ Note ] ModScan designed to use PLC address (Base 1), so the polling address entered needs to be 1301. Users can make sure the actual polling address is [05][14] (1300) by selecting “Show Traffic” of the “Display Option” within “Setup” menu after successful connected, shown as Figure 3-7

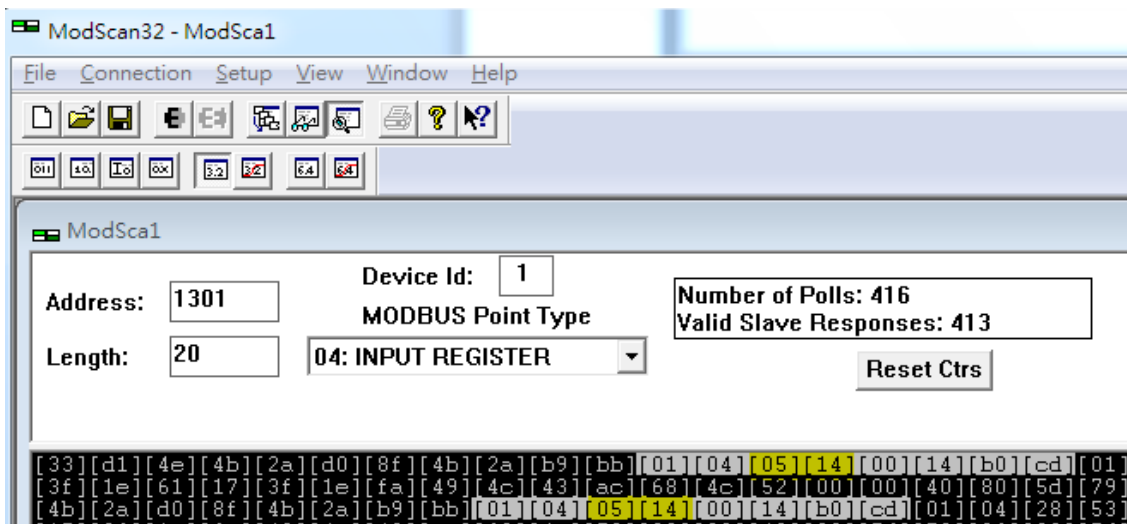

**Figure 3-7 The actual polling Modbus address**

<6> Check and modify Modbus Poll Address Base types and display formats like Figure 3-8.



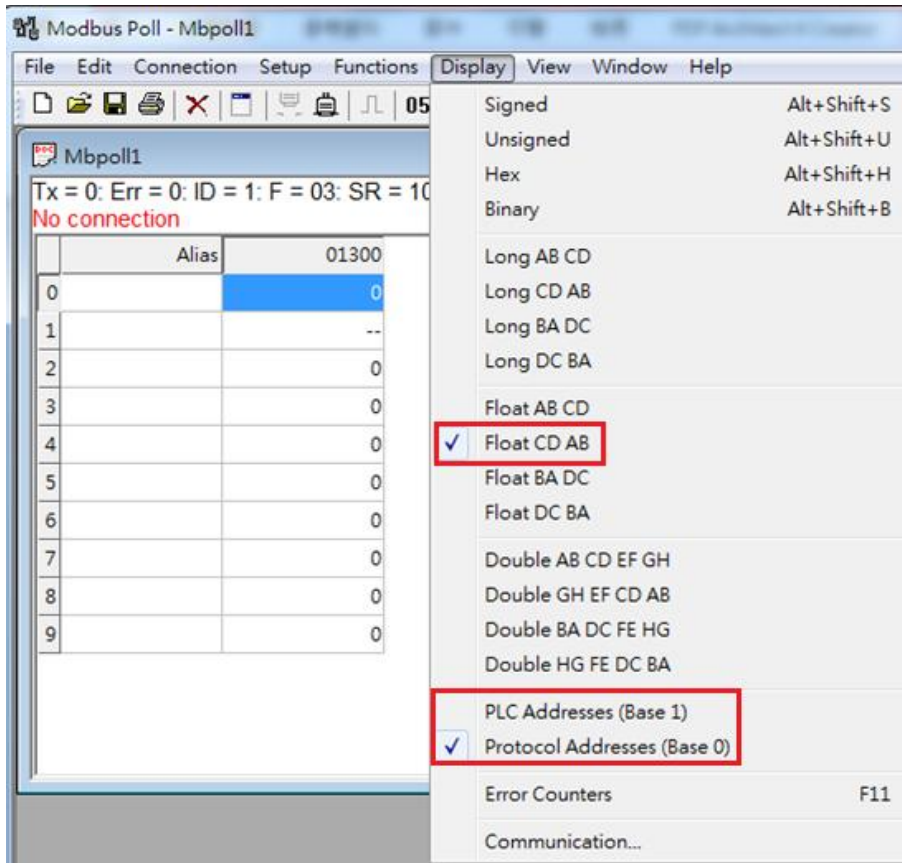

**Figure 3-8 Address Base types and display formats**

<7> Set the “Read/Write Definition” of Modbus Poll like Figure 3-9.

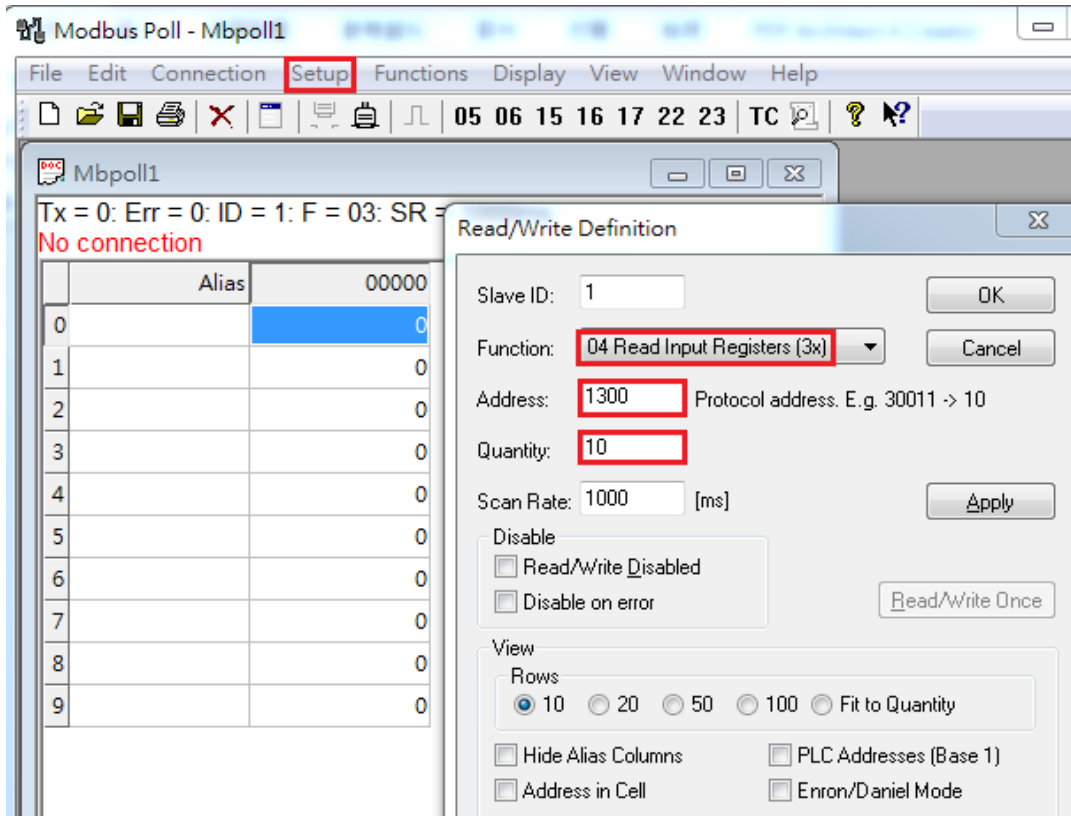

**Figure 3-9 “Read/Write Definition” of Modbus Poll tool**

[ Note ] The polling address is 1300 in this case because “Protocol Address (Base 0)” has been selected for Modbus Poll. If “PLC Address Poll (Base 1)” has been selected instead, then the address needs to be set as 1301. Users can make sure the actual polling address is [05][14] (1300) by checking the “Communication” dialog from “Display” menu after successful connected, shown as Figure 3-10

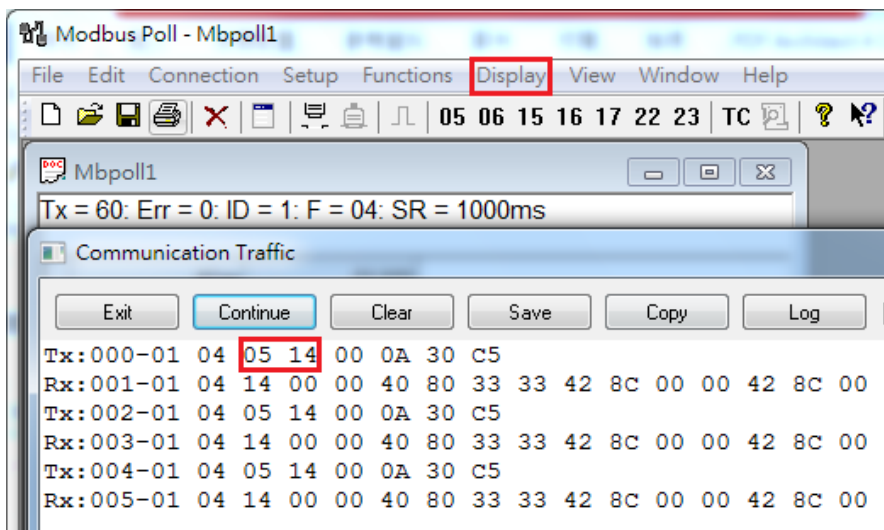

**Figure 3-10 Polling address from “Communication Traffic”**

<8> Set the “Com Port” parameters and click “OK” button to connect to HRT-711 like Figure 3-11.

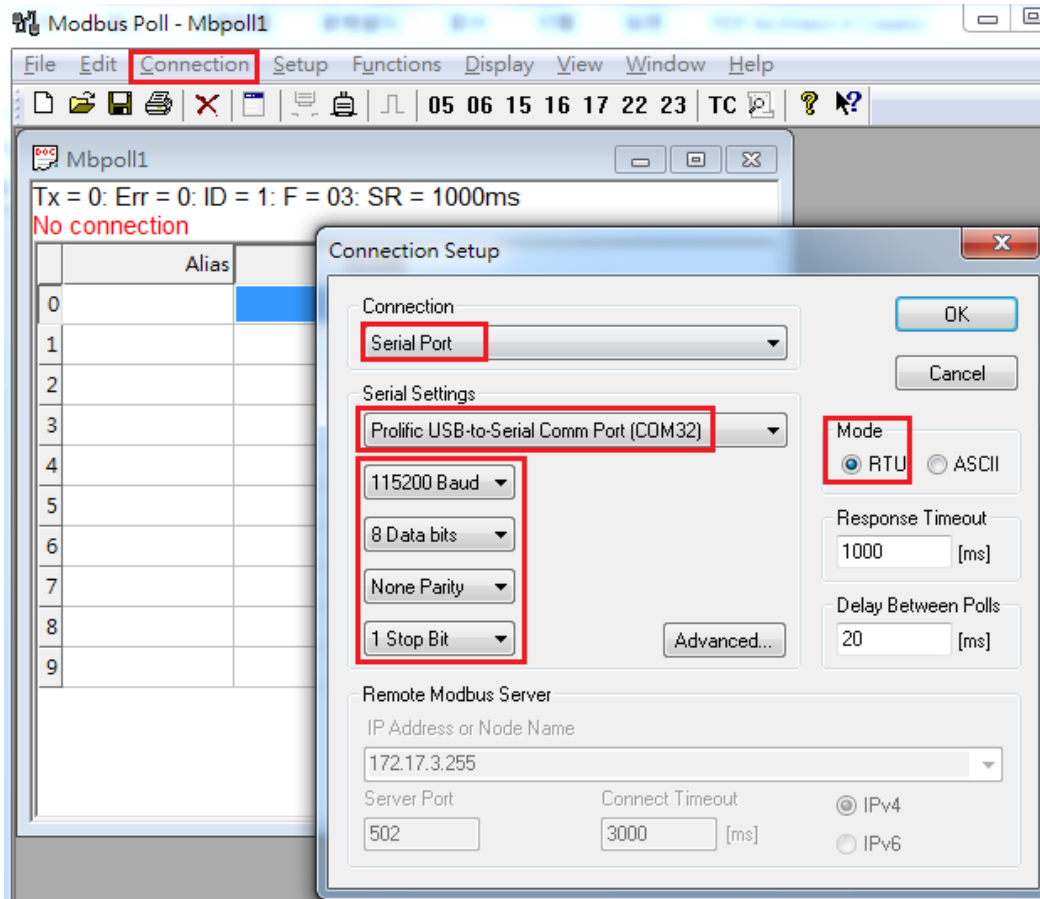

**Figure 3-11 Com Port Parameters of “Modbus Poll” tool**

<9> The CMD(3) data of HART device is shown like Figure 3-12.

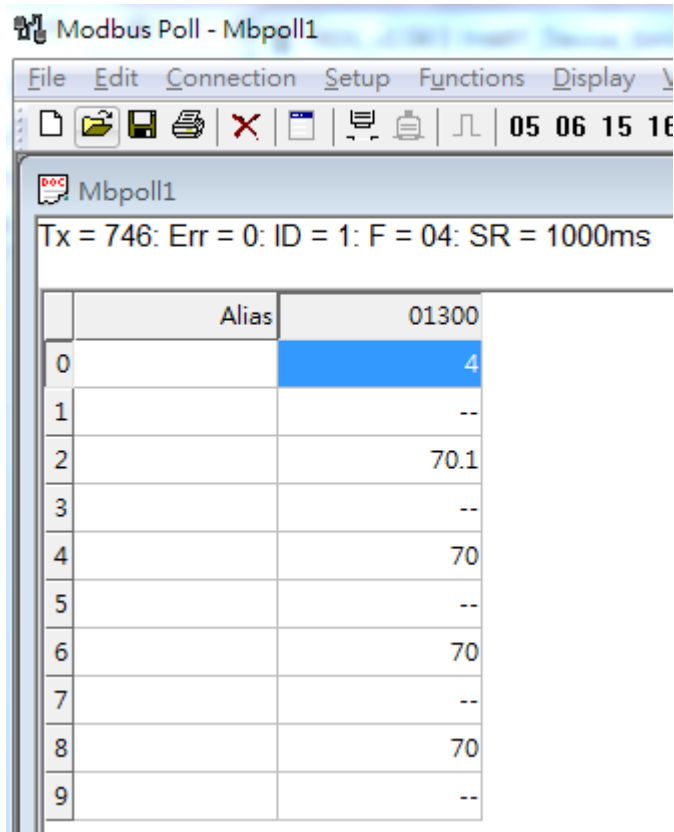

**Figure 3-12 The CMD(3) data of HART device**

[ Note ] The simple CMD(3) data format and value are shown as below.

Byte Index	Format	Description
00~03	Float	Primary Variable Current
04~07	Float	Primary Variable
08~11	Float	Secondary Variable
12~15	Float	Tertiary Variable
16~19	Float	Quaternary Variable

## Q04 : How to update the firmware of HRT-711 ?

A04: (2018/05/22)

HRT-711 allows user to update firmware of TCP and HART separately. To update firmware please follow the below steps:

### [ HART Firmware Update ]

(1) Download the newest firmware of HRT-711.

(Download from: [ftp://ftp.icpdas.com/pub/cd/fieldbus\\_cd/hart/gateway/hrt-711/firmware/](ftp://ftp.icpdas.com/pub/cd/fieldbus_cd/hart/gateway/hrt-711/firmware/) )

(2) Turn off the power. Set HRT-711 to be “Init” mode and open the upper chassis of HRT-711.

Then switch jumper to pin 2 & 3 for JP2 and JP3.

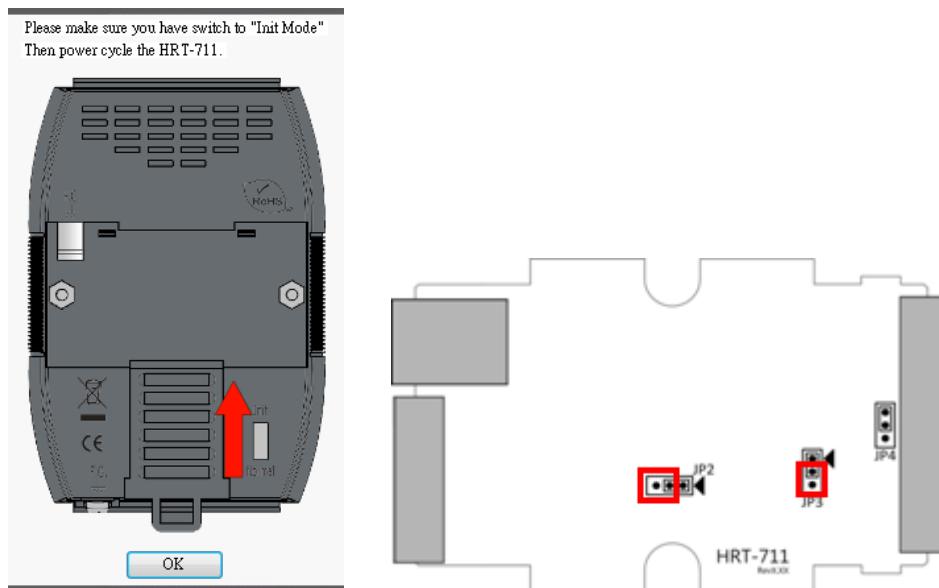

(3) Using RS-232 cable to connect PC and HRT-711, and then turn on the power. (All LEDs will be off)

(4) Run “FW\_Update\_Tool”

(Download from: [ftp://ftp.icpdas.com/pub/cd/fieldbus\\_cd/hart/gateway/hrt-711/utilities](ftp://ftp.icpdas.com/pub/cd/fieldbus_cd/hart/gateway/hrt-711/utilities) )

[1] Choose “COM” option and select “Com Port number”.

[2] Click “Browser” button to choose the firmware of HRT-711.

[3] Click “Firmware Update” button to start firmware update process.

[4] Wait for “Firmware Update Success” message.

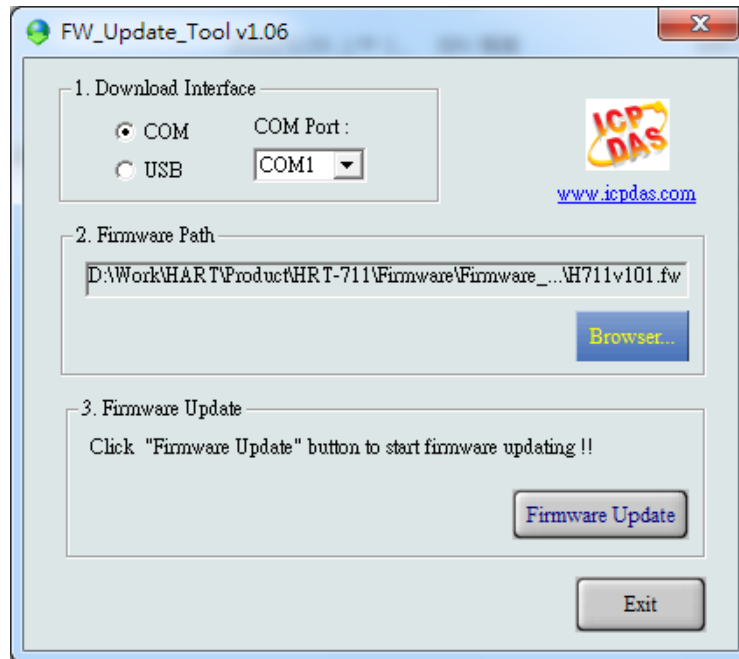

(5) Turn off the power and switch JP2 and JP3 back to pin 1 & 2.



(6) Close the shell and turn on the power of HRT-711. Then users can check the firmware version of HRT-711 by using “HRT-711 Utility”.

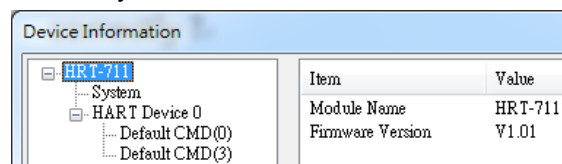

### [ TCP Firmware Update ]

(1) Download the latest version of eSearch Utility:

<http://ftp.icpdas.com/pub/cd/tinymodules/napdos/software/esearch/>

(2) Download the latest version of HRT-711 TCP firmware

[ftp://ftp.icpdas.com/pub/cd/fieldbus\\_cd/hart/gateway/hrt-711/firmware/TCP/](ftp://ftp.icpdas.com/pub/cd/fieldbus_cd/hart/gateway/hrt-711/firmware/TCP/)

(3) Switch the dip-switch of HRT-711 to “Init” Mode

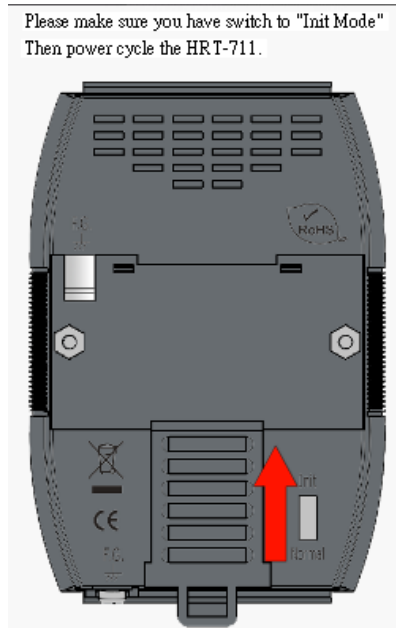

(4)Run eSearch Utility:

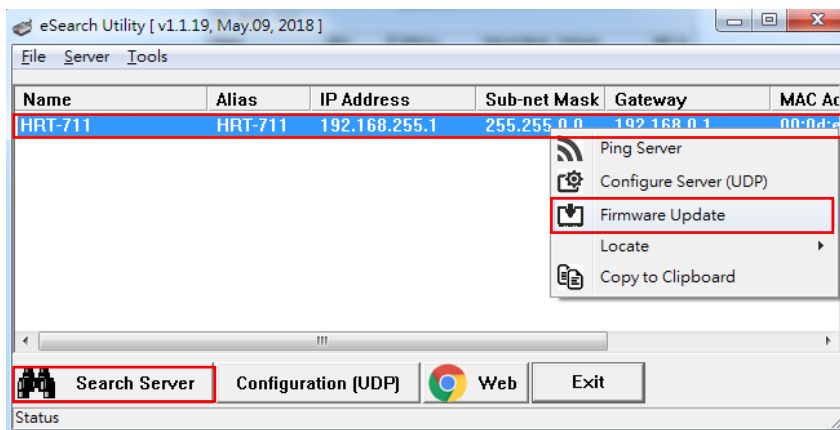

- [1] Select "Search Server"
- [2] Right click "HRT-711"
- [3] Select "Firmware Update"

(5)Choose TCP firmware file (.dat)

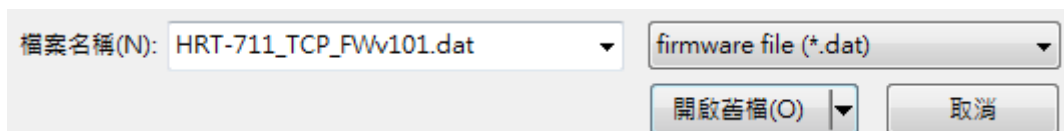

(6)Reboot HRT-711 when the following dialog shows



(7)Firmware update failure

```
C:\Windows\system32\cmd.exe
Waiting request from MAC 00-0d-e0-80-55-71 <IP:192.168.255.1>
Starting BOOTP/TFTP Server ...
BOOTPREQ from MAC: 00-0D-E0-80-55-71
```

(8)Firmware update success

```
C:\Windows\system32\cmd.exe
ARP 項目刪除失敗: 要求的作業需要提升的權限。
Waiting request from MAC 00-0d-e0-8f-ff-ff <IP:192.168.255.1>
Starting BOOTP/TFTP Server ...
BOOTPREQ from MAC: 00-0D-E0-8F-FF-FF
% Complete: 100%
請按任意鍵繼續 . . .
```

(9)“Search Server” again and check HRT-711 firmware version

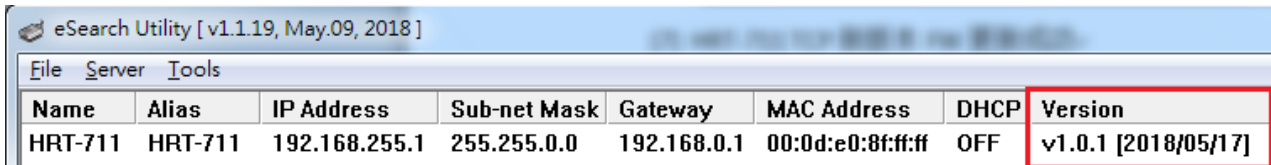

Name	Alias	IP Address	Sub-net Mask	Gateway	MAC Address	DHCP	Version
HRT-711	HRT-711	192.168.255.1	255.255.0.0	192.168.0.1	00:0d:e0:8f:ff:ff	OFF	v1.0.1 [2018/05/17]



**Q05 : How to read HART device command 1 data with standard format by Modbus ?**

(1) By using “HRT-711 Utility” to add “User CMD(1)” of HART device and save settings to HRT-711. The Modbus start address and length of the “User CMD(1)” will show in the “Cmd In address” and “Cmd In size” field. In the example they are 0 and 7 (byte count=7 => word count=4).

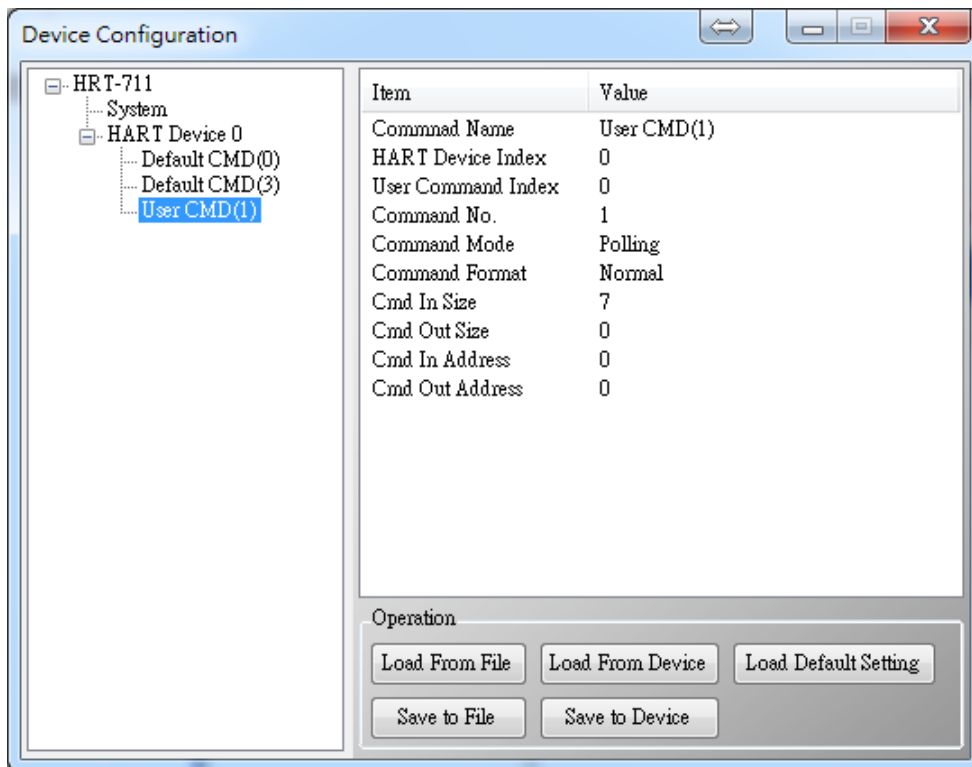
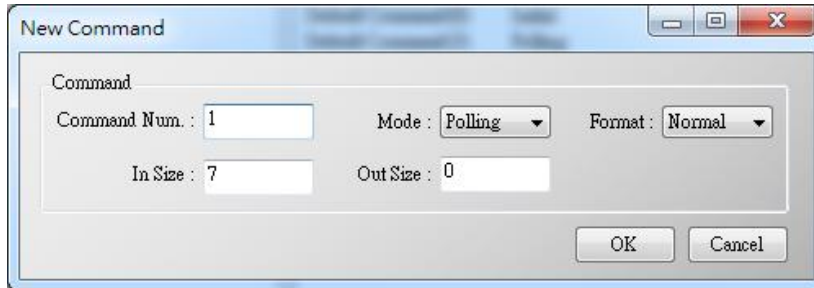
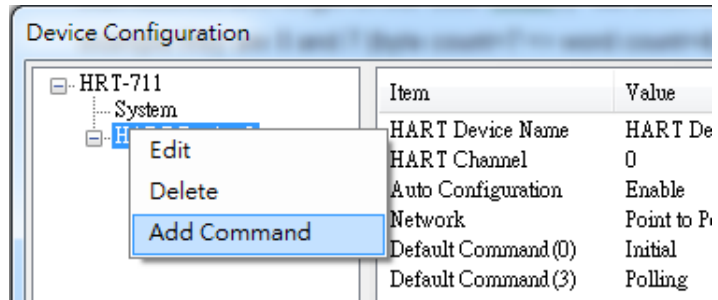

- (2) The below demo will use the free MBTCP tool provided by ICP DAS to show HART command 1 data. (Download from [http://ftp.icpdas.com.tw/pub/cd/8000cd/napdos/modbus/modbus\\_utility/](http://ftp.icpdas.com.tw/pub/cd/8000cd/napdos/modbus/modbus_utility/))
- (3) Run “MBTCP” tool. Fill the settings (IP and Port) and then click “Open” button to connect to HRT-711.
- (4) Input “1 4 0 0 4” in “Command” field and click “Send Command” button to send the modbus command. The HART command 1 data will be received in “Responses” field => “01 04 08 0C BA 00 10 00 00 D5 F0”.

Send Modbus Command : 01 04 00 00 00 04

Get Response : 01 04 08 0C BA 00 10 00 00 D5 F0

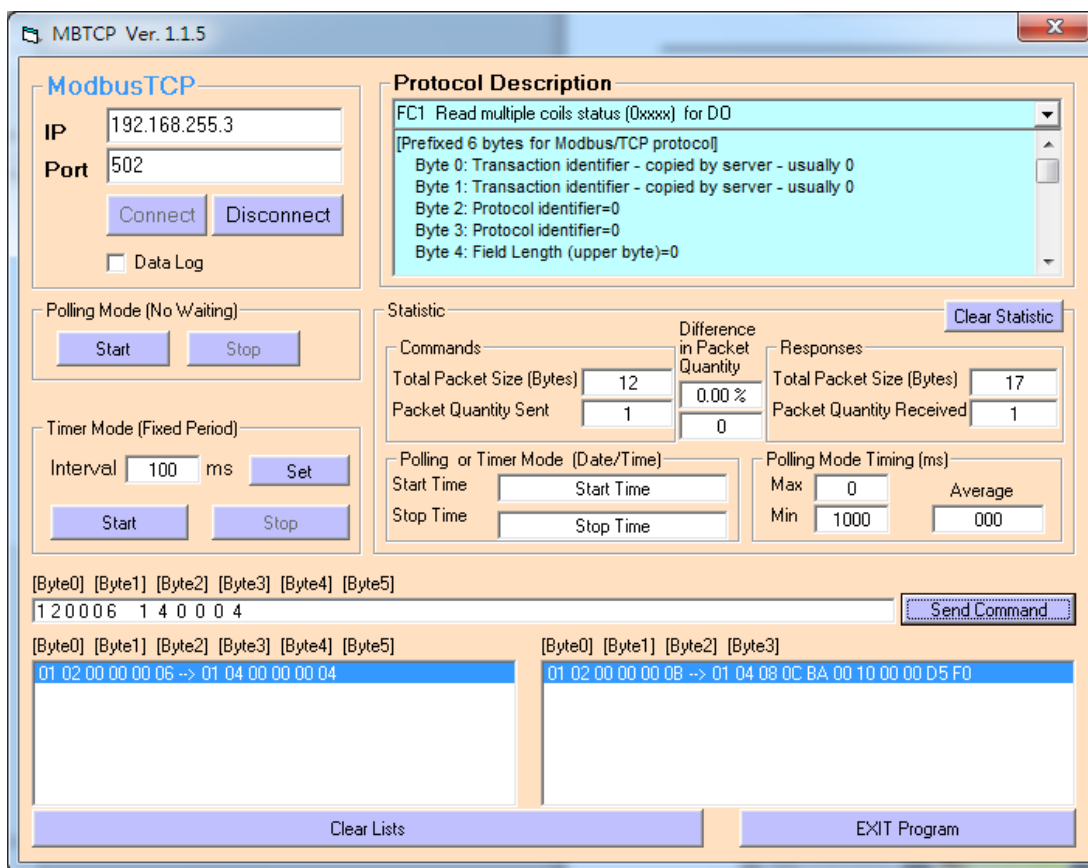

- (5) Parse the Modbus response data.

Response Data => 01 04 08 0C BA 00 10 00 00 D5 F0

Register data => 0C BA 00 10 00 00 D5 F0

Because the unit of HART-711’s database is byte and the unit of Modbus register is word and the Modbus register is composed of database’s byte and the order is low byte first.

(For example: Modbus register0 = 0x3412, database byte0 = 0x12, byte1 = 0x34).

So we need to change the byte order.

So the data will be BA 0C 10 00 00 00 F0 D5.

And we have set the swap mode to Word & Byte, so the data transform into 00 10 0C BA D5 F0 00 00.

According to the data count is 7, so the actual data will be 00 10 0C BA D5 F0 00

About the format of HART Command 1, it is shown as the table below.

Request Data Bytes	0	
Response Data Bytes	2 + 5 = 7	
Byte Index	Format	Description
0	Uint8	Response Code 1
1	Uint8	Response Code 2
2	Uint8	Unit code
3~6	Float	Primary Variable

So the data of HART command 1 is parsed as below.

Response code1 = 0x00

Response code2 = 0x10

Primary Variable Unit code = 0x0C (kPA)

Primary Variable = 0xB5 0xD5 0xF0 0x00 (-0.001632 => IEEE754)

## Q06 : How to read HART device command 3 data with standard format by Modbus ?

- (1) When adding a new HART device to HRT-711, the “Default CMD(3)” will be added automatically. The Modbus start address and length of the “Default CMD(3)” will show in the “Cmd In address” and “Cmd In size” field. In the example they are 1236 (For MB Addr = 618 = 0x026A) and 26 (byte count=26 => word count=13).

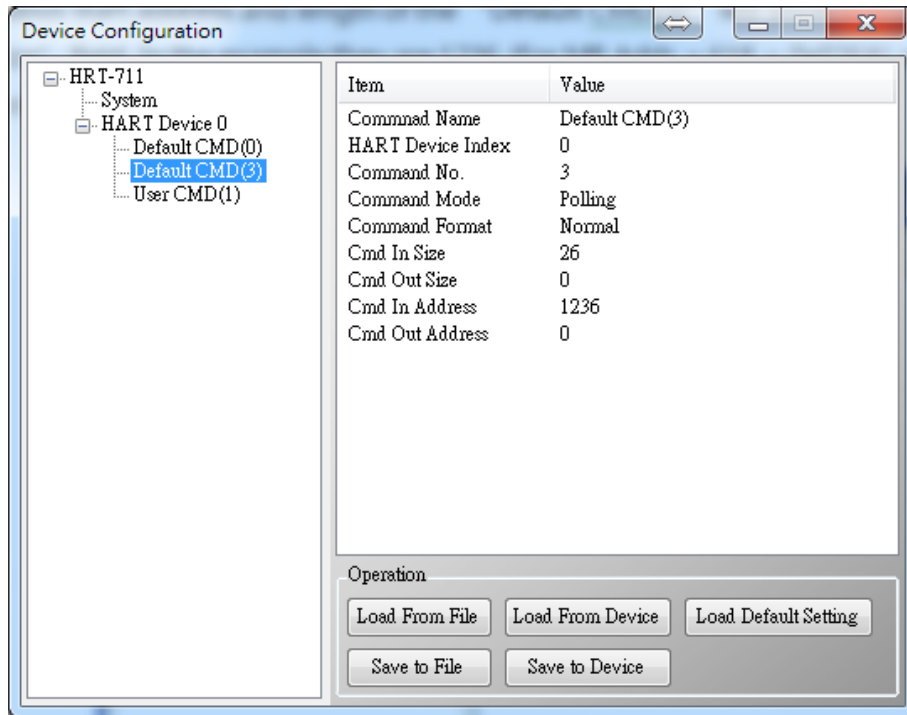

- (2) The below demo will use the free MBTCP tool provided by ICP DAS to show HART command 1 data. (Download from [http://ftp.icpdas.com.tw/pub/cd/8000cd/napdos/modbus/modbus\\_utility/](http://ftp.icpdas.com.tw/pub/cd/8000cd/napdos/modbus/modbus_utility/))

- (3) Run “MBTCP” tool. Fill the settings (IP and Port) and then click “Open” button to connect to HRT-711

- (4) Input “01 04 02 6A 00 0D” in “Command” field and click “Send Command” button to send the modbus command. The HART command 3 data will be received in “Responses” field => “01 04 1A 10 00 7F 40 A0 E7 BB 0C F4 00 20 00 CE 41 E8 2D BC 39 58 18 00 00 00 00 00 00”

Send Modbus Command : 01 04 02 6A 00 0D 10 6B

Get Response : 01 04 1A 40 7F 00 10 0C BB E6 64 00 20 03 94 FA 51 41 CD 20 0F 39 BC 00 00 00 00 00

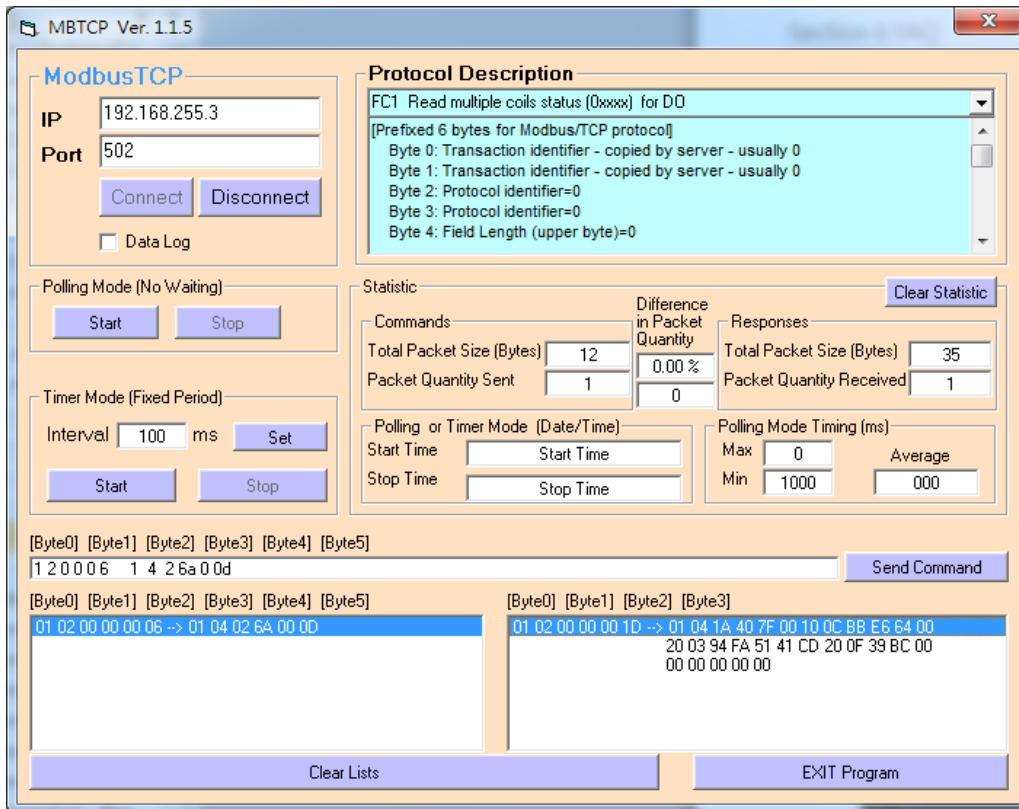

(5) Parse the Modbus response data.

Response Data => 01 04 1A 40 7F 00 10 0C BB E6 64 00 20 03 94 FA 51 41 CD 20 0F 39 BC 00 00 00 00 00 00

Register data => 40 7F 00 10 0C BB E6 64 00 20 03 94 FA 51 41 CD 20 0F 39 BC 00 00 00 00 00

Because the unit of HART-711's database is byte and the unit of Modbus register is word and the Modbus register is composed of database's byte and the order is low byte first.

(For example: Modbus register0 = 0x3412, database byte0 = 0x12, byte1 = 0x34).

So we need to change the byte order. So the data will be as below.

7F 40 10 00 BB 0C 64 E6 20 00 94 03 51 FA CD 41 0F 20 BC 39 00 00 00 00 00 00

According to the swap setting, we set the Word and Byte swap in this example, so the data will be transformed into.

00 10 40 7F E6 64 0C BB 03 94 00 20 41 CD FA 51 39 BC 20 0F 00 00 00 00 00 00

About the format of HART Command 3, it is shown as the table below.

Request Data Bytes	0	
Response Data Bytes	2 + 24 = 26	
Byte Index	Format	Description
0	UInt8	Response Code 1
1	UInt8	Response Code 2
2~5	Float	Primary Variable Current
6	UInt8	Primary Variable Unit code
7~10	Float	Primary Variable
11	UInt8	Secondary Variable Unit code
12~15	Float	Secondary Variable
16	UInt8	Tertiary Variable Unit code
17~20	Float	Tertiary Variable
21	UInt8	Quaternary Variable Unit code
22~25	Float	Quaternary Variable

So the data of HART command 3 is parsed as below.

Response code1 = 0x00

Response code2 = 0x10

Primary Variable Current = 0x40 0x7F 0xE6 0x64 (3.998437)

Primary Variable Unit code = 0x0C (kPA)

Primary Variable = 0xBB 0x03 0x94 0x00 (-0.0020077229)

Secondary Variable Unit code = 0x20 (degC)

Secondary Variable = 0x41 0xCD 0xFA 0x51 (25.747225)

Tertiary Variable Unit code = 0x39 (Percent)

Tertiary Variable = 0xBC 0x20 0x0F 0x00 (-0.009769201)

Quaternary Variable Unit code = 0x00 ( ???)

Quaternary Variable = 0x00 0x00 0x00 0x00 (0)

## Q07 : How to know the connection status between HRT-711 and HART devices ?

The communication status description of HART command in HRT-711 is as below.

Value	Error Status
0	No error
1	The command has never be executed
2	Receive timeout, can't receive any HART data
3	Receive HART data is too short
4	The delimiter of HART data has some error
5	The address (the bit of master type) of HART data has some error
6	The address (the bit of burst mode) of HART data has some error
7	The command of HART data has some error
8	The parity of HART data has error
9	The communication with HART slave device has some error and the error messages are recorded in the responses codes

### [ Ex1 => The Default CMD(3) of “HART Device 0 & 1” in HRT-711 is Polling Mode ]

< 1. The setting of SWAP Mode is “None” (without Byte and WORD swap) >

(1) Address 1000 (Unit: WORD) : Show the comm. status of “Device 0”.

[1] High Byte : “The comm. status of Default CMD(3) in device 0.

[2] Low Byte : “The comm. status of Default CMD(0) in device 0.

(2) Address 1001 (Unit: WORD) : Show the comm. status of “Device 1”.

[1] High Byte : “The comm. status of Default CMD(3) in device 1.

[2] Low Byte : “The comm. status of Default CMD(0) in device 1.

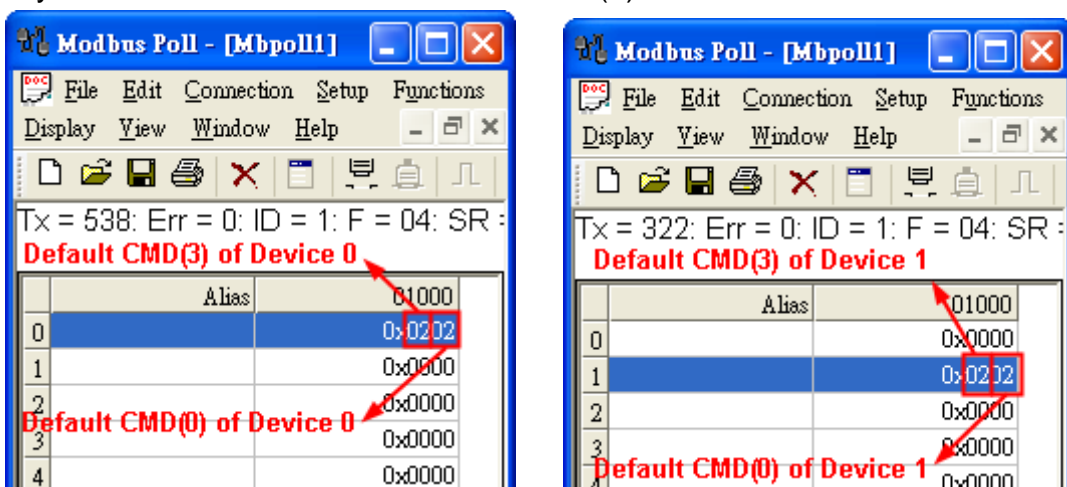

Figure 7-1.1 The status of Default CMD(0&3) in Device 0 and Device 1

< 2. The setting of SWAP Mode is “W&B” (with Byte and WORD swap) >

(1) Address 1001 (Unit: WORD) : Show the comm. status of “Device 0”.

[1] High Byte : “The comm. status of Default CMD(0) in device 0.

[2] Low Byte : “The comm. status of Default CMD(3) in device 0.

(2) Address 1000 (Unit: WORD) : Show the comm. status of “Device 1”.

[1] High Byte : “The comm. status of Default CMD(0) in device 1.

[2] Low Byte : “The comm. status of Default CMD(3) in device 1.

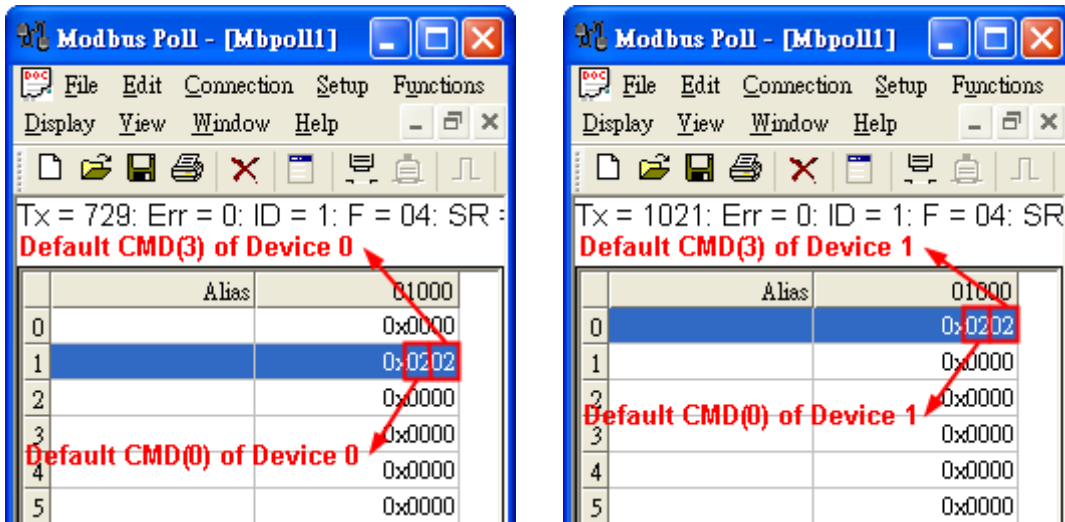

Figure 7-1.2 The status of Default CMD(0&3) in Device 0 and Device 1

In the Figure 7-1, the status of the Default CMD(3) in device 0 is 0x02 and it means that the HART device for the Default CMD(3) is disconnected from HRT-711. (In the Figure 7-1, the status of the Default CMD(0) is 0x02, too.)

**[ Ex2 => The User CMD Index = 0 is Polling Mode ]**

By using the low and high byte value of MB address 1050 (unit: WORD) (refer to sector 4.2 – Modbus / HART Mapping Table), users can get the communication status of the User CMD Index = 0 and 1.



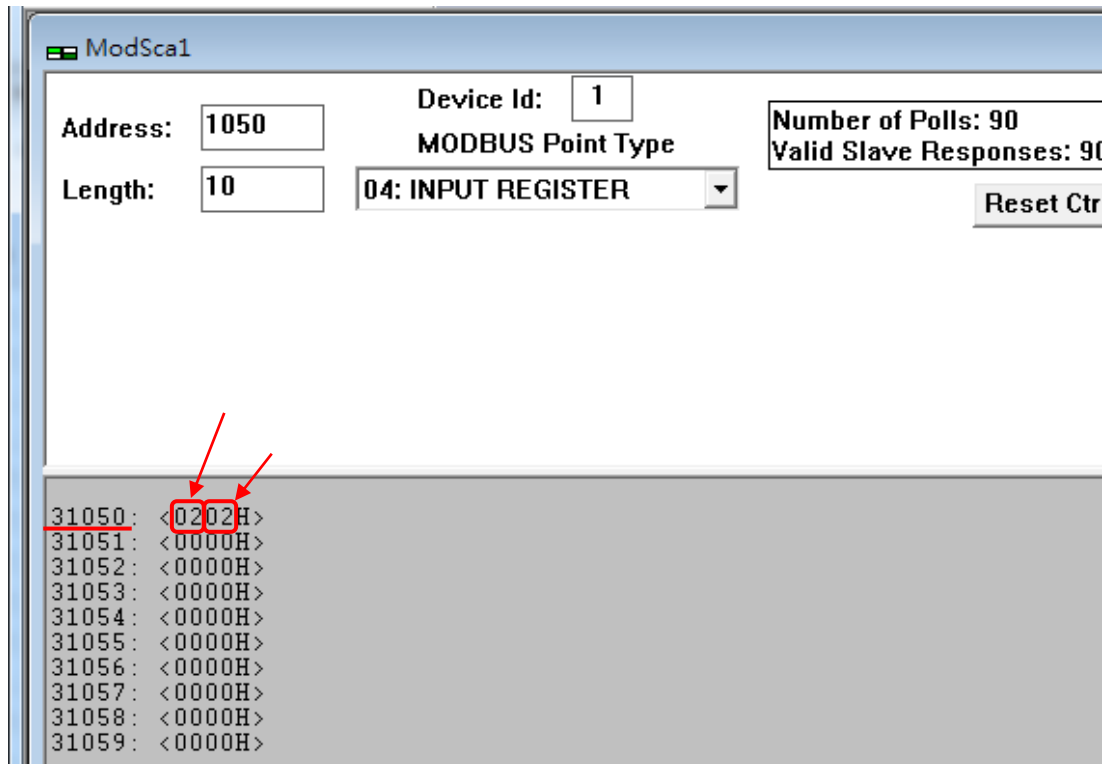

The status of the User CMD Index = 0 and 1 are 0x02. It means that the HART device for the User CMD Index = 0 and 1 is disconnected from HRT-711.

**Q08 : How to integrate Active and Passive HART devices in multi-drop network ?**

- 1. If there are more than 7 HART devices in the HART network, users need to disable the internal resistor (250 Ohm, 1/4W) of HRT-711 (adjust JP4 to be pin2 and pin3, refer to the section 2.6 for detailed). Then add the external resistor (250 Ohm, 1W) in HART network.
- 2. The HART wiring of the Active and Passive HART devices, please refer the following figure.

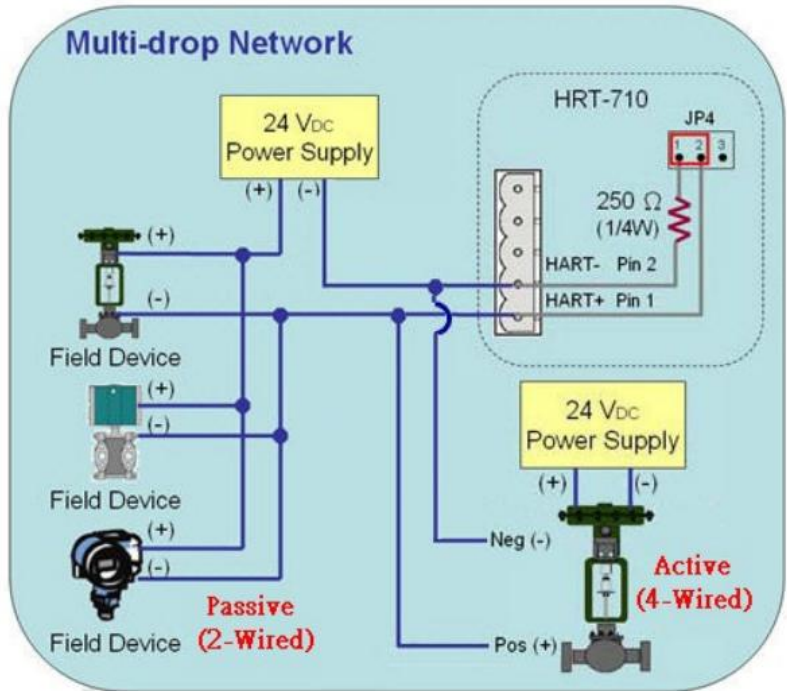

## **Q09 : How to integrate multiple HRT-711 modules in the same project ?**

### **[ Case Example ]**

1. A user wants to integrate 20 HART devices (Ultrasonic Water Level) in the same project via Modbus/TCP or Modbus/UDP communication and HART wiring will be point to point.

### **[ Solution ]**

#### **< Hardware >**

1. We suggest the user to use 20 HRT-711 modules to connect to 20 HART devices with point to point wiring.

#### **< Software >**

1. The HRT-711 is a Modbus/TCP and Modbus/UDP server, if users need to multiple HRT-711, users follow section 5.4 to configure the Ethernet. After configuring HRT-711's Ethernet and connecting to Ethernet switch, all HRT-711 can be identified by the IP address.

## Q10 : How to integrate HART communication device with RS-232 hardware interface ?

### [ Case Example ]

1. A user wants to integrate HART communication device (Flowmeter, Mobrey MCU900) with RS-232 hardware interface.

### [ Solution ]

#### < Hardware >

1. We suggest the user to use HRT-711 and I-7570 to do that and the wiring for this case.

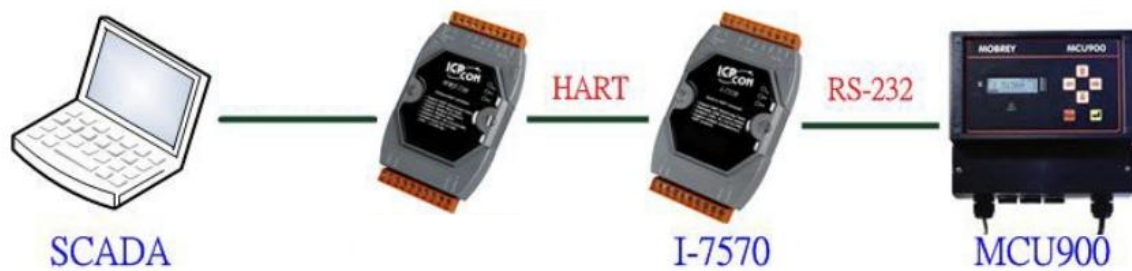

#### < Software >

1. Please refer to the steps in the Q01, Q02 and Q03 of HRT-711 FAQ to integrate HART device information to SCADA.

# Q11 : How to add the HART Device-Specific command to HRT-711 ?

## [ Case Example ]

1. An user wants to get the HART command No.149 data from Emerson 8800D HART device.

## [ Solution ]

### < Software >

1. Users must get the HART Device-Specific command first. The HART command No.149 format of Emerson 8800D.

**Command 149 - Read Fixed Process Density**

REQUEST DATA BYTES  
NONE

RESPONSE DATA BYTES  
BYTE 0  
1-4

8-bit unsigned integer.  
IEEE 754 floating point format.

2. Add the HART command No.149 to HRT-711.

**Device Configuration**

Item	Value
HART Device Name	HART Device 0
Channel	0
Configuration	Enable
Command(0)	Point to Point
Default Command(3)	Initial
Default Command(3)	Polling

**New Command**

Command  
Command Num. : 149      Mode : Polling      Format : Normal

In Size : 5      Out Size : 0

OK      Cancel

3. After the setting is finished, in the Device Configuration screen, please click the Save to Device button to save the parameters to HRT-711.

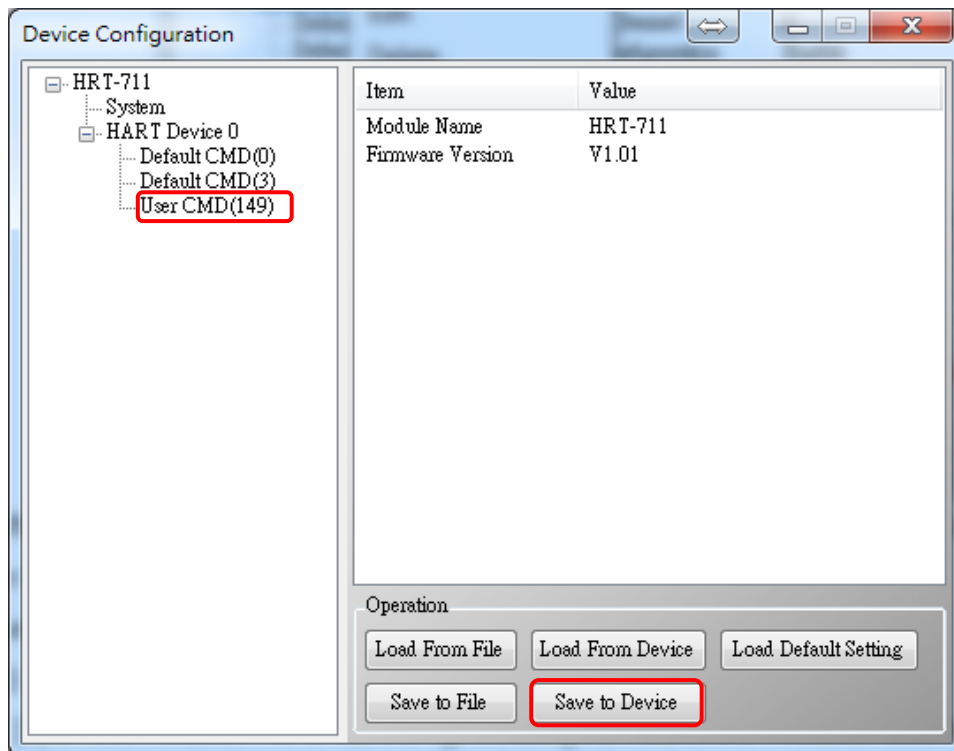

4. Get the Modbus address for the HART command No.149 data.

(1) Open the “Address Map” screen and click the “UserCMD(149)” item.

[1] In the Modbus AO area, the light blue grid means the Modbus address for data sending.

[2] In the “Modbus AI” area, the light blue grid means the Modbus address for data receiving.

=> In the case, the HART command No.149 is used for reading data. Therefore, the light blue grid just show in “Modbus AI” area and the Modbus address for receiving data is from 0 to 2.

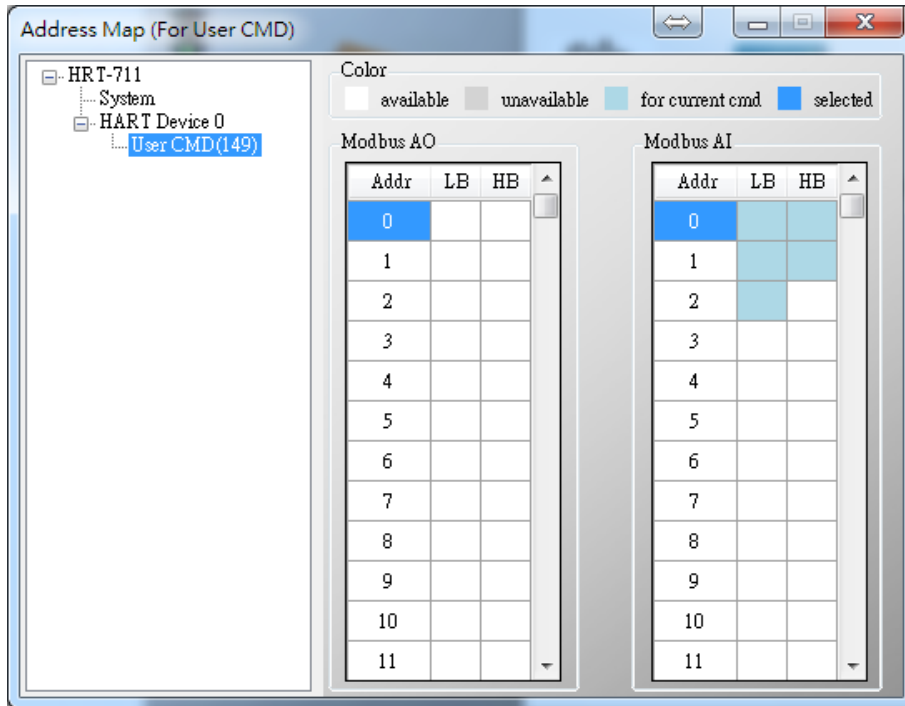

(2) Users can use the Modbus Function Code 4 and address from 0 to 2 to get the HART command No.149 data. (Ex: Request Cmd => 0x01 0x04 0x00 0x00 0x00 0x03)

## Q12 : How to set HART device address by HRT-711 utility ?

1. Add the UserCMD(6) to HRT-711 :

- (1) Run HRT-711 Utility and connect to HRT-711.
- (2) Open the Device Configuration page.
- (3) Add UserCMD(6) and choose Manual option in Mode field.
- (4) Click Save to Device button.

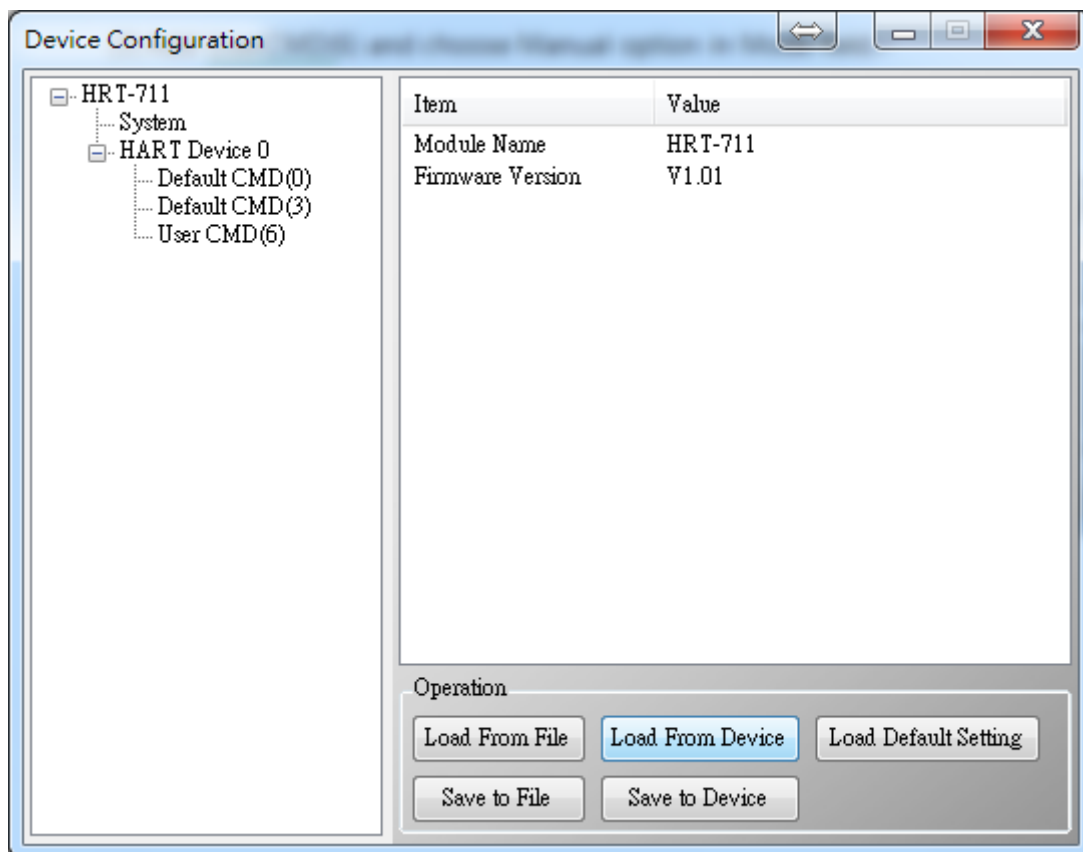
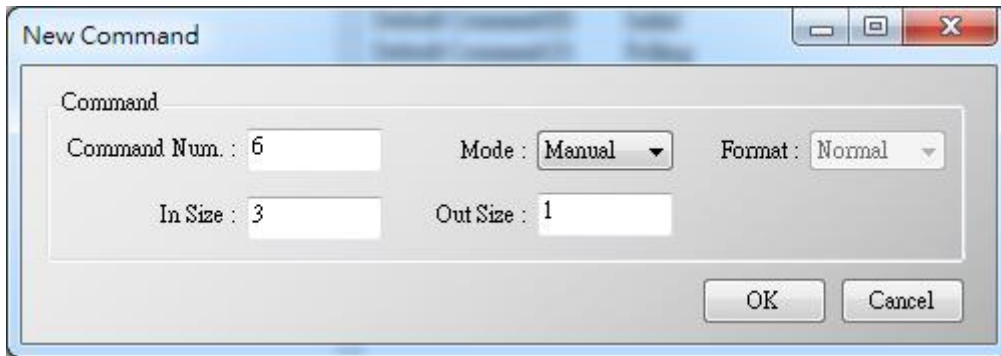

2. Set HART device address and send the UserCMD(6) :

- (1) Open Device Information page.
- (2) Right click on the UserCMD(6) item and choose the Basic Operation.  
(In the demo, the command index is 0 for the UserCMD(6).)



- (3) Input the HART device address value and click the Send button.  
 (In the demo, HART device address will be set to be 2. Now the setting value is just saved in HRT-711 not sent out yet.)

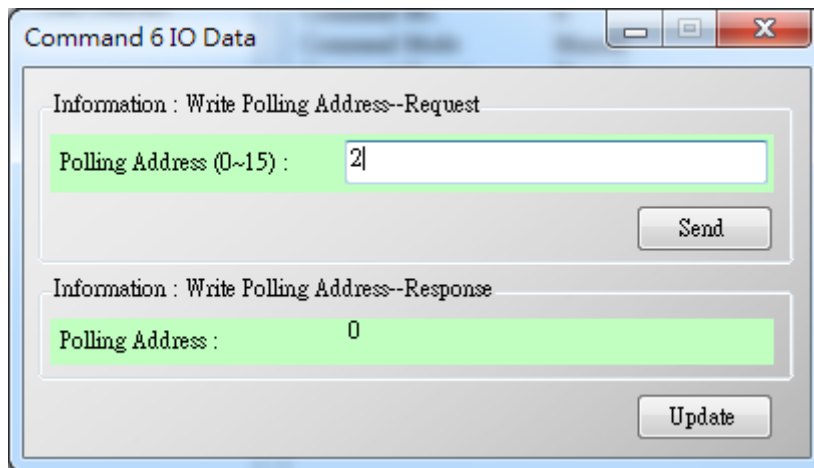
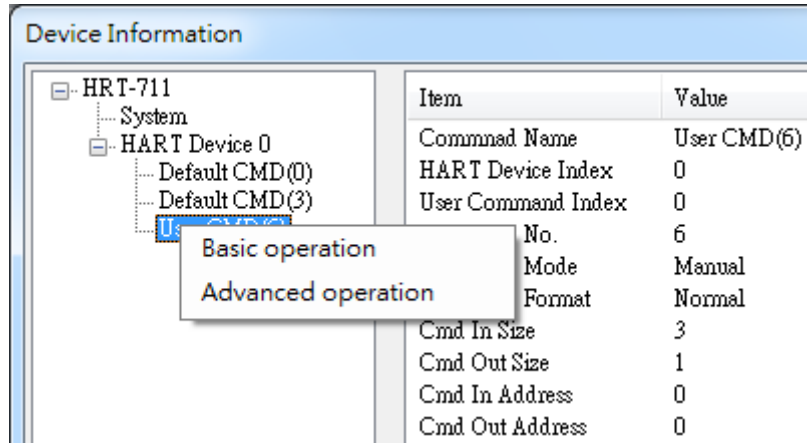

- (4) Right click on the System item and choose the Basic Operation.  
 (5) After finishing the below settings, click Send Data button to send the UserCMD(6) to HART device.
- [1] Auto Polling field => Disable
  - [2] Manual Trigger field => Enable
  - [3] Trigger Index of User Command field => Input 0 (UserCMD(6) Index)

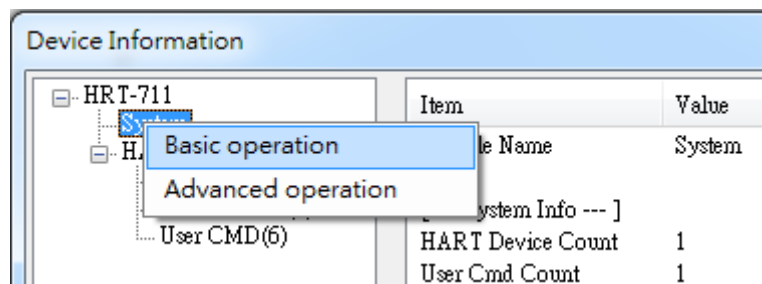

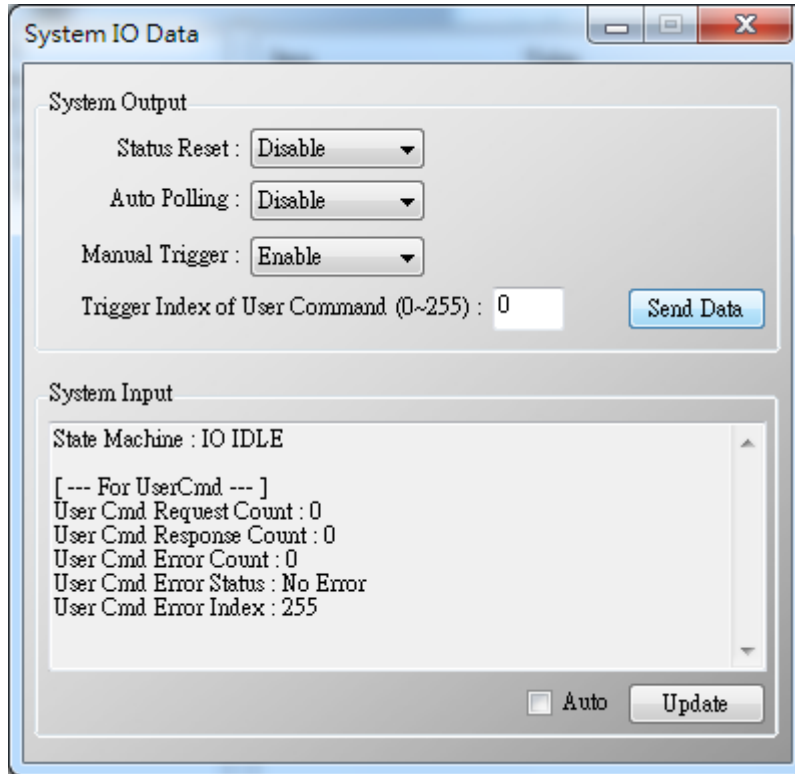

3. Now the HART device address should be set to be 2. Then please reboot HRT-711.  
(After changing device address, please also remember to modify the device address in the Device Configuration)

### Q13 : All kinds of HART network wiring ?

A13: (2015/10/26)

1. The wiring of "Point to Point" :

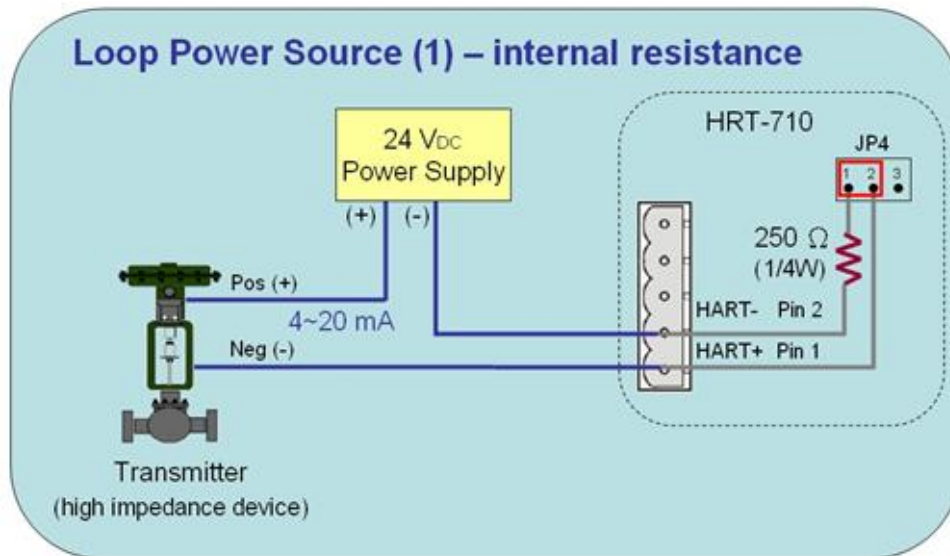

Figure 13-1 HART\_P2P\_Network\_Passive (In-Resistor)

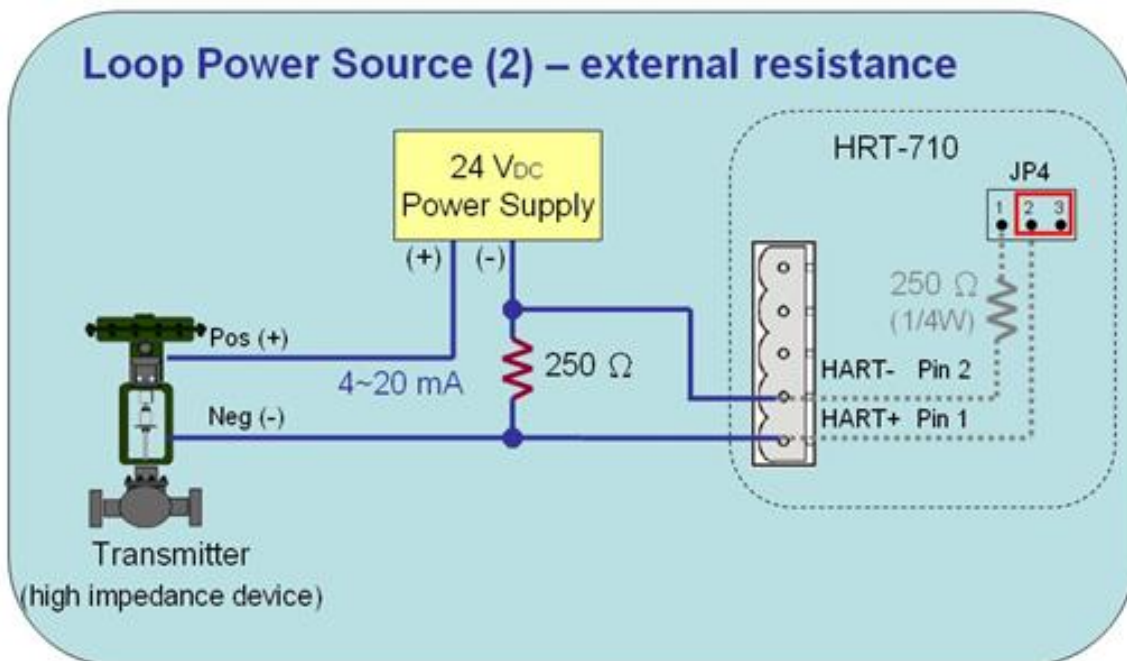

Figure 13-2 HART\_P2P\_Network\_Passive (Ext-Resistor)

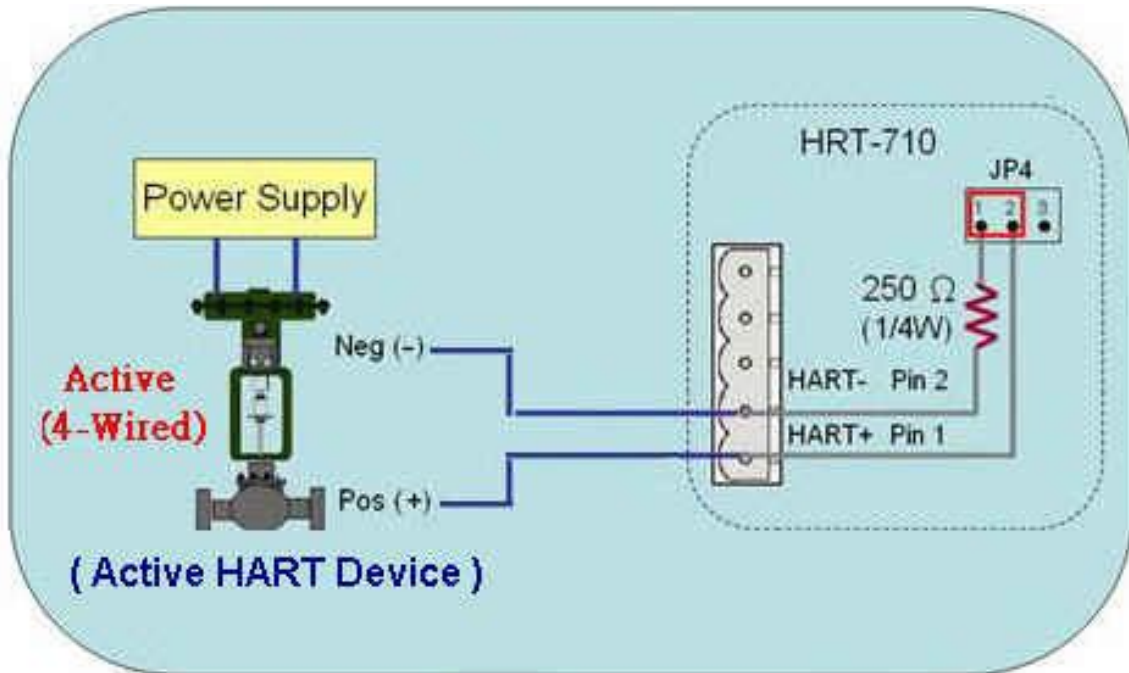

Figure 13-3 HART\_P2P\_Network\_Active (In-Resistor)

2. The wiring of "Multi-Drop":

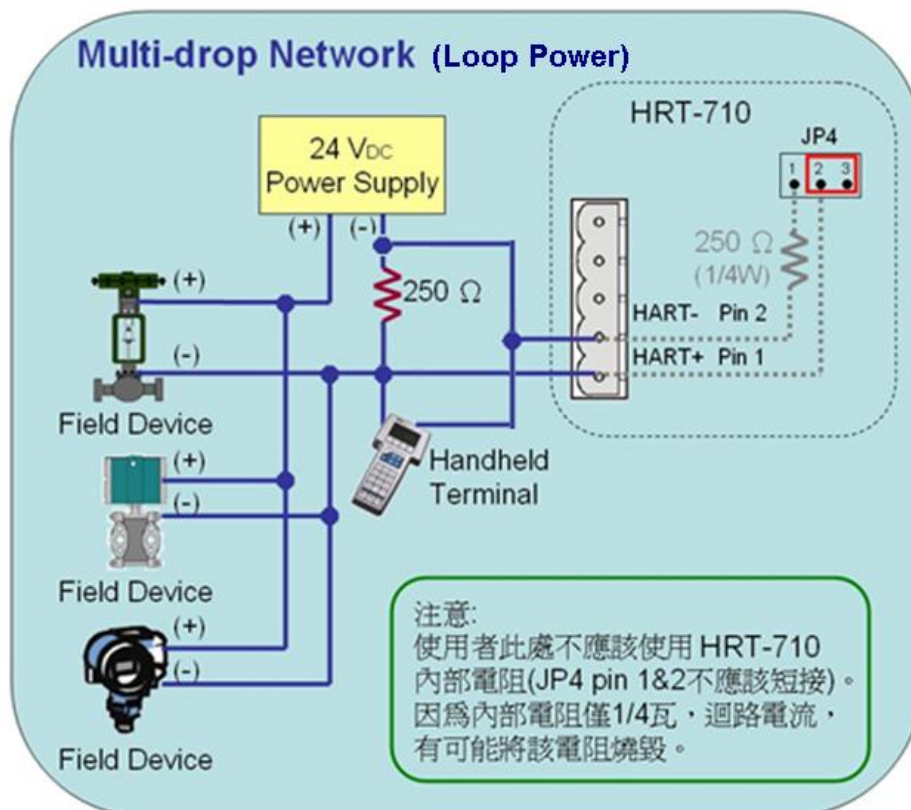

Figure 13-4 HART\_Multi-Drop\_Network\_Passive.jpg

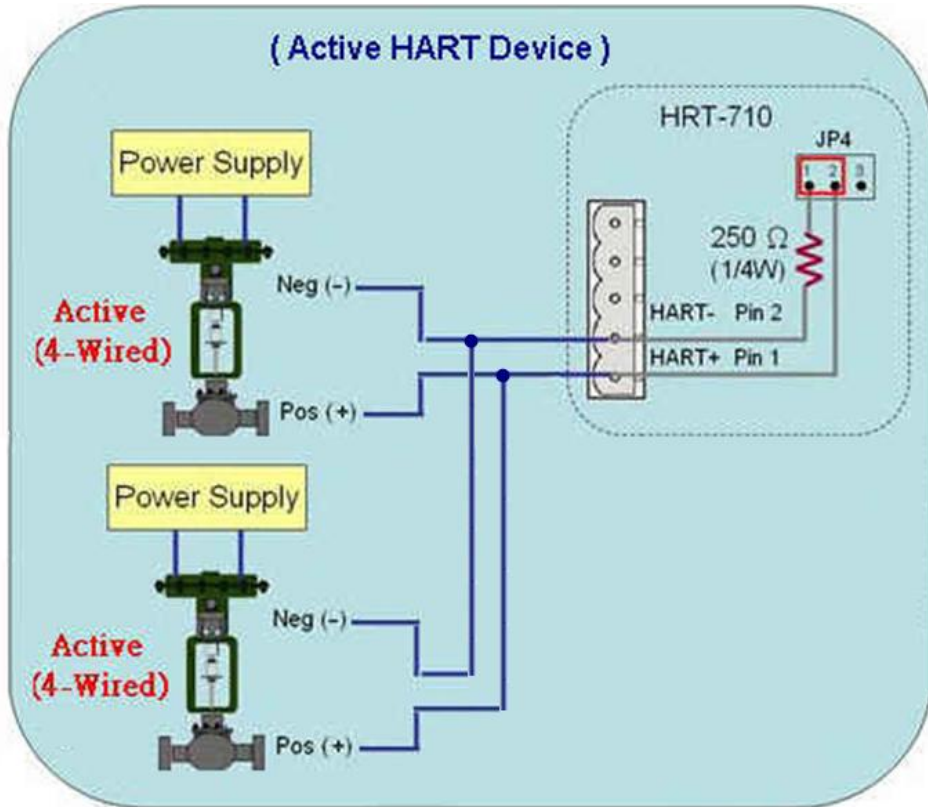

Figure 13-5 HART\_Multi-Drop\_Network\_Active

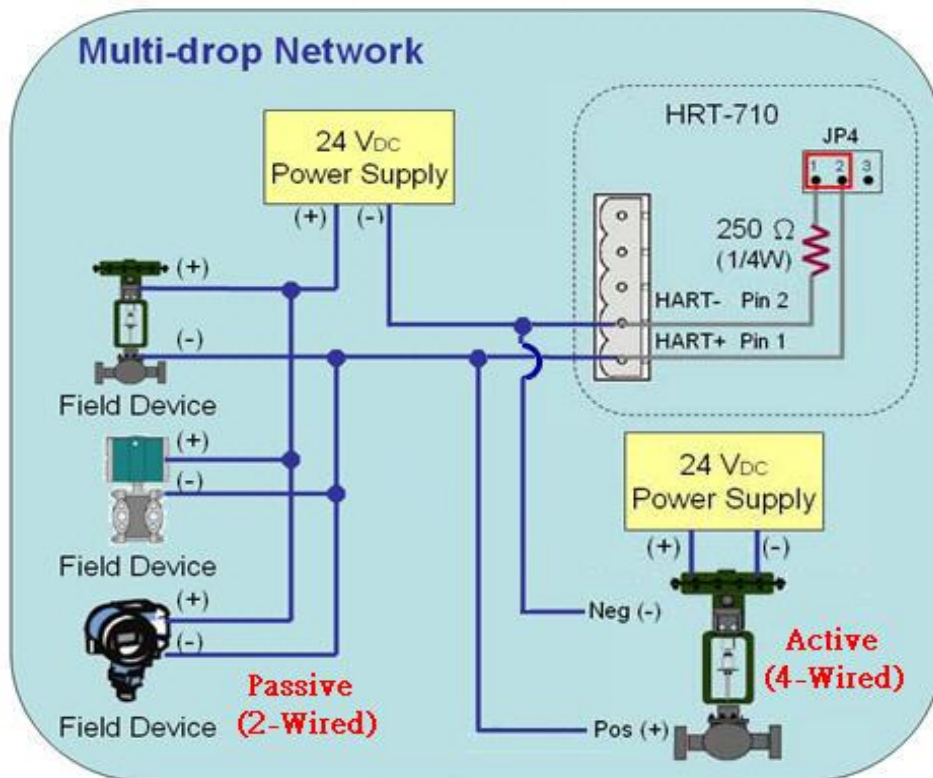

Figure 13-6 HART\_Multi-Drop\_Network\_Active & Passive

## Q14 : Apply the same settings to the other HRT-711 rapidly ?

A14: (2015/12/21)

1. Save HRT-711 settings to file.

(1) Run the HRT-711 utility, HG\_Tool.

(2) In the “Device Configuration” page, click the “Save to File” button to save the current settings of HRT-711 to file.

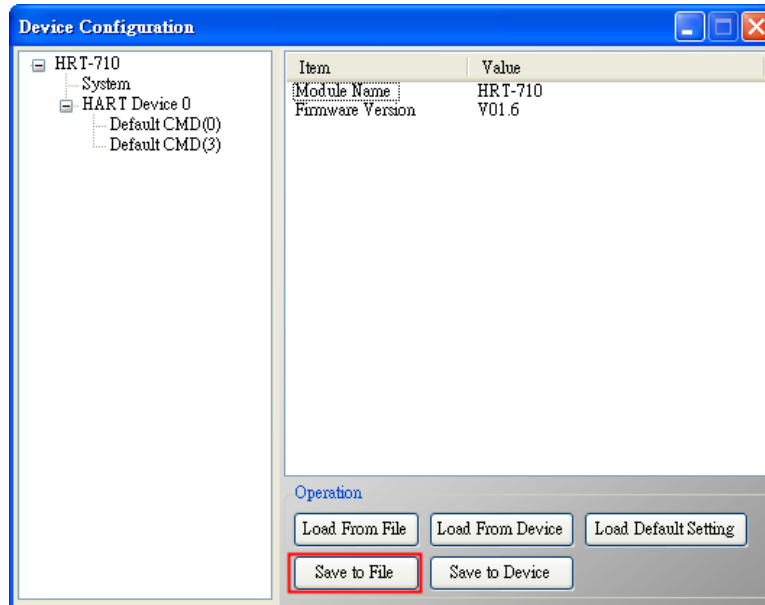

2. Load the settings from HRT-711 file to the other HRT-711 module.

(1) In the “Device Configuration”, click the “Load From File” button and choose the setting file of HRT-711. Then it will show all the settings in the HG\_Tool.

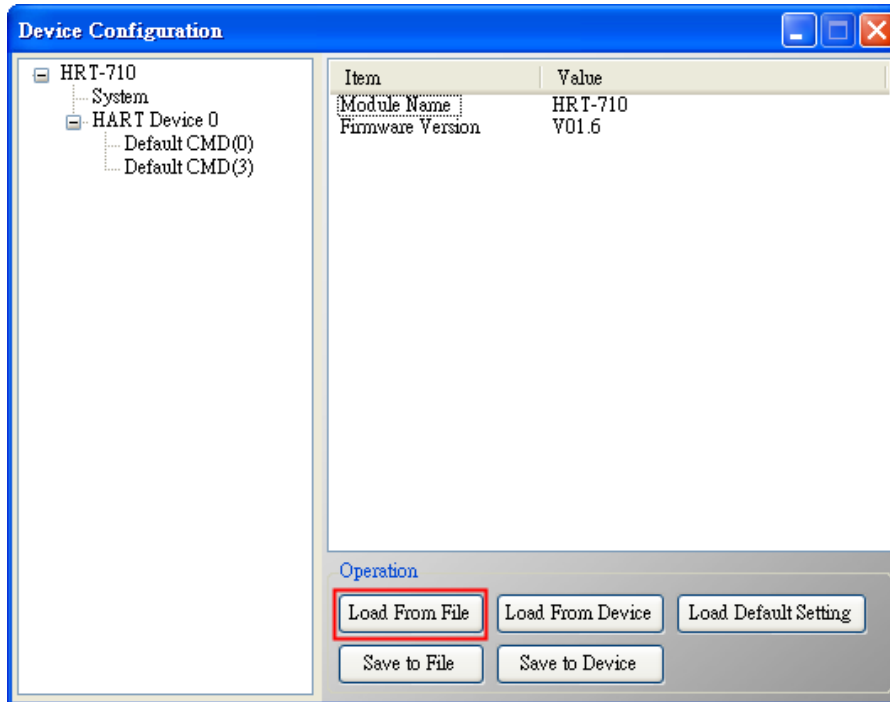

(2) Click the “Save to Device” button to set the settings to HRT-711 module.

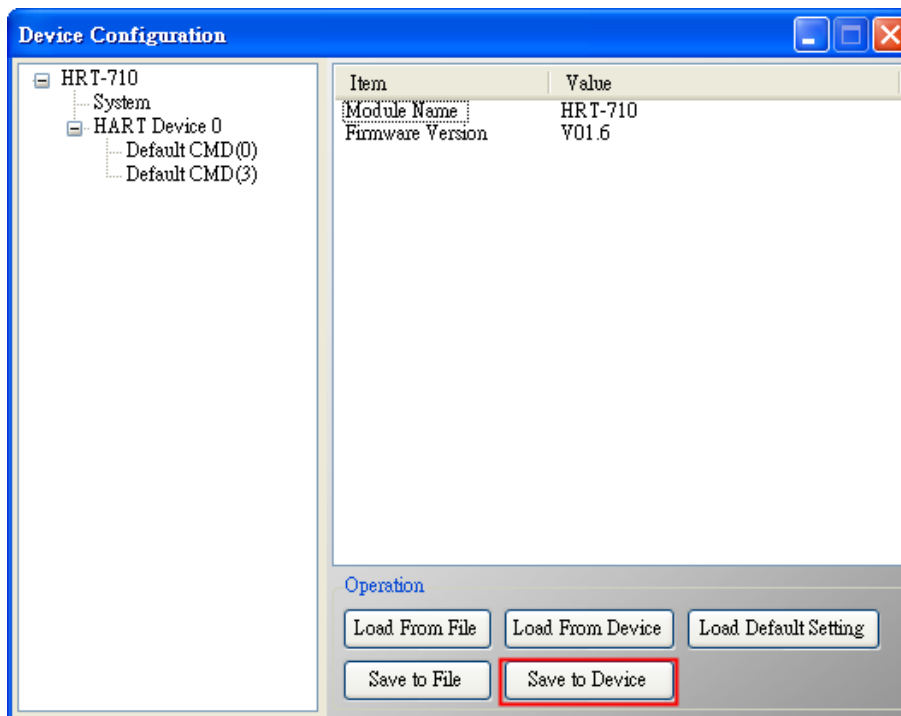



### Q15 : How to send HART command for writing ? (Ex: CMD19)

A15: (2015/12/23)

1. Add the HART command for writing in HRT-711.

(The HART cmd 19 is used in the below example => Final Assembly Number)

(1) In the “Device Configuration” page, click the right button of mouse on the “HART Device 0” item and choose the “Add Command” option.

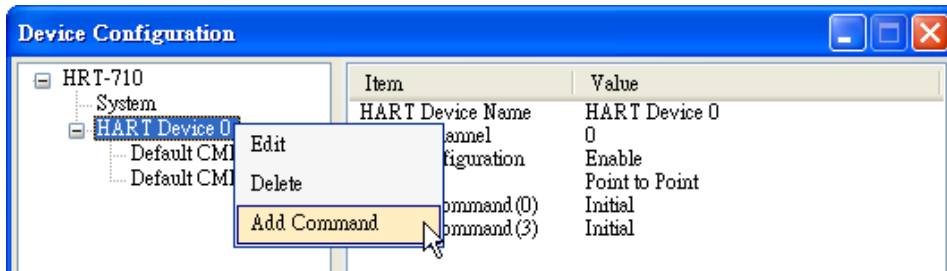

(2) Input the value “19” in the “Command Num” field and choose the “Manual” option in the “Mode” field. Click the “OK” button to add the HART command 19 (Now the User Command Index is 0) and click the “Save to Device” button to save the current settings to HRT-711.

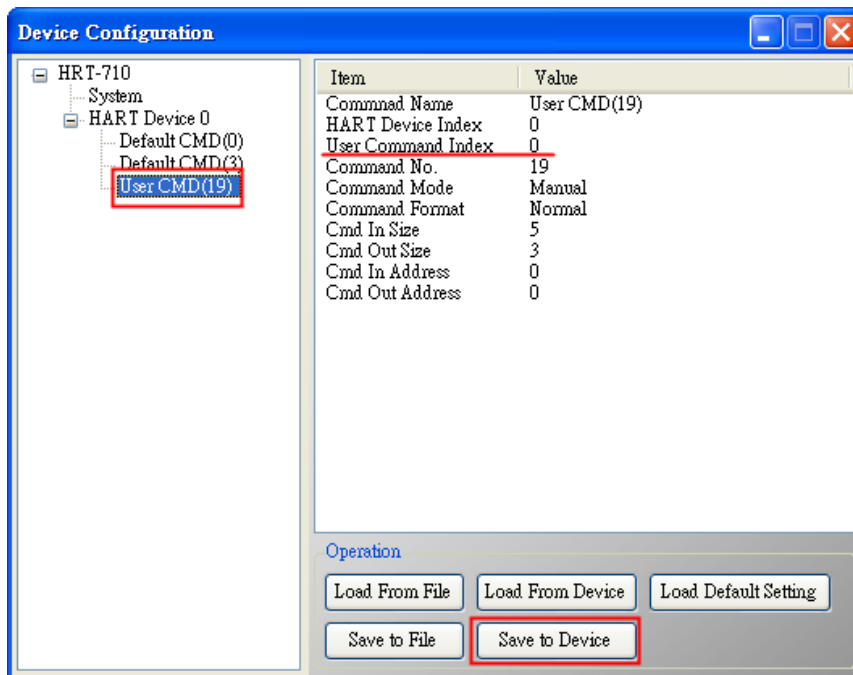
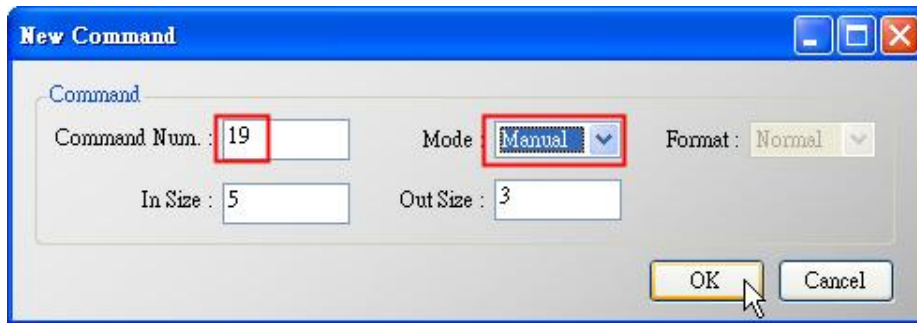



2. Set the value for the HART writing command. (HART command not yet sent)
  - (1) There are three bytes parameters for HART command 19.
  - (2) For example, the value for these three bytes parameters is 11(0x0B), 22(0x16), 33(0x21) for writing, and the Modbus command will be as below.  
 => 01 **06** 00 00 **0B 16** 0F 34  
 => 01 **06** 00 01 **21 00** C0 5A
  - (3) The below figure is the assigned value for writing in HART command 19 by using ModScan software for testing.

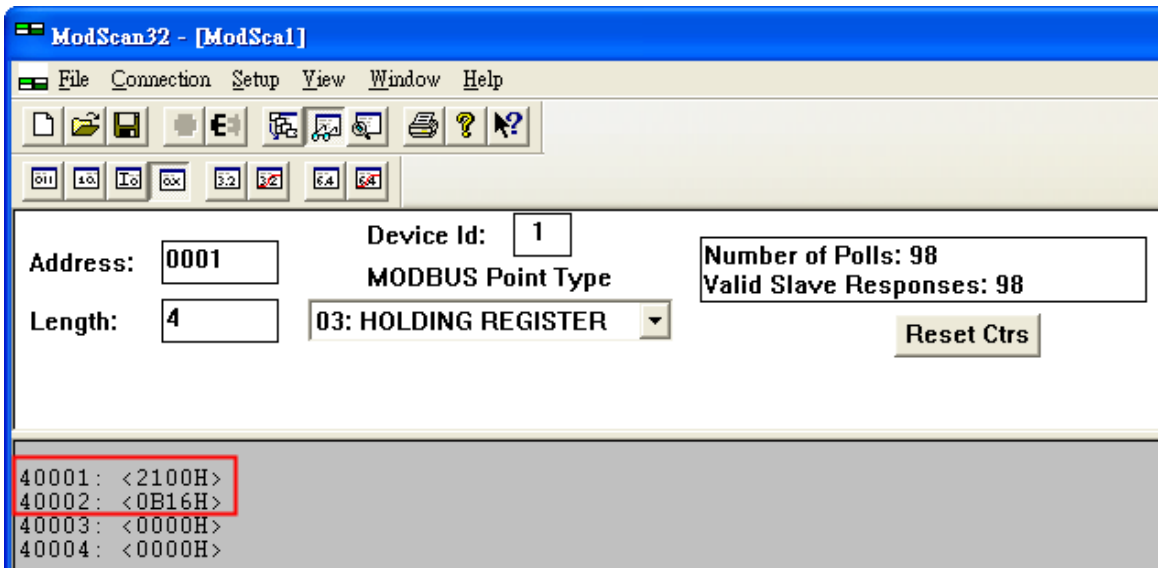

(4) After sending the above Modbus command, users can check if these values have been set successfully via HG\_Tool.

- [1] In the “Device Information” page, click the right button of mouse on the “User CMD(19)” item and choose the “Advanced operation” option.

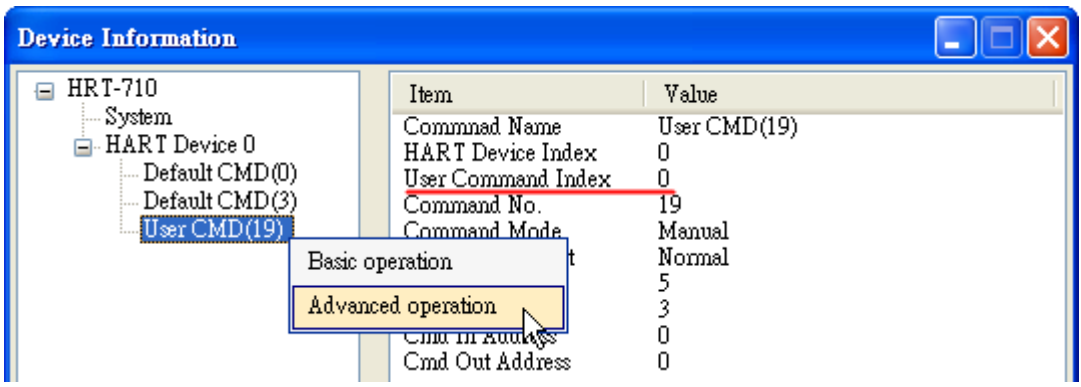

[2] In the “I/O Data” page, click the “Update” button and it will show the value for sending of UserCMD in the corresponding byte address in the “Output Data” area. Users can see these values of “11”, “22” and “33” been set successfully.

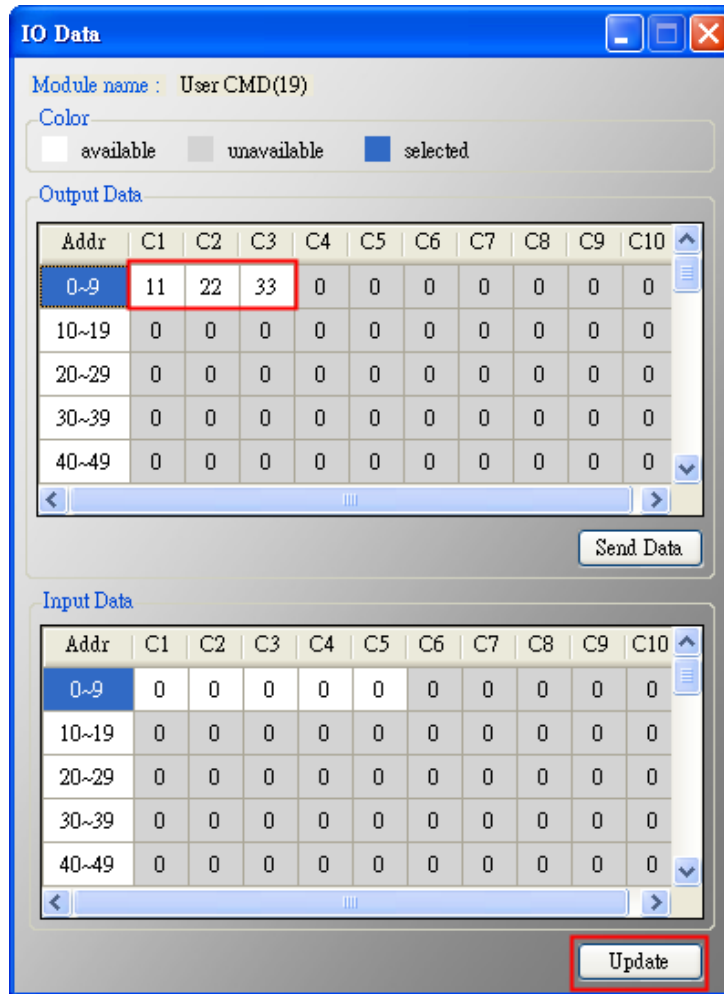

3. Trig the HRT-711 to send the UserCMD0 (HART command 19).

(1) Stop the original HART polling command and send the UserCMD0.

The Modbus command will be as below.

=> 01 06 **01 F5 00 00 98 04**

=> 01 06 **01 F6 01 00 69 94**

[1] **00** : Stop all the original HART polling command.

[2] **00** : Set the no. of UserCMD for sending.

[3] **01** : Trig to send the UserCMD and it needs the different value every time.

(Ex: the next value will be 2, 3, 4 ...)

=> Now the UserCMD0 (HART command 19) has been sent.

(2) Recover the original HART polling command.

The Modbus command will be as below.

=> 01 06 **01 F5 01 00 99 94**

[1] **01** : recover all the original HART polling command.

### Q17 : How to get HART command 48 information ?

A17: (2016/10/07)

1. Add HART CMD 48 to HRT-711.

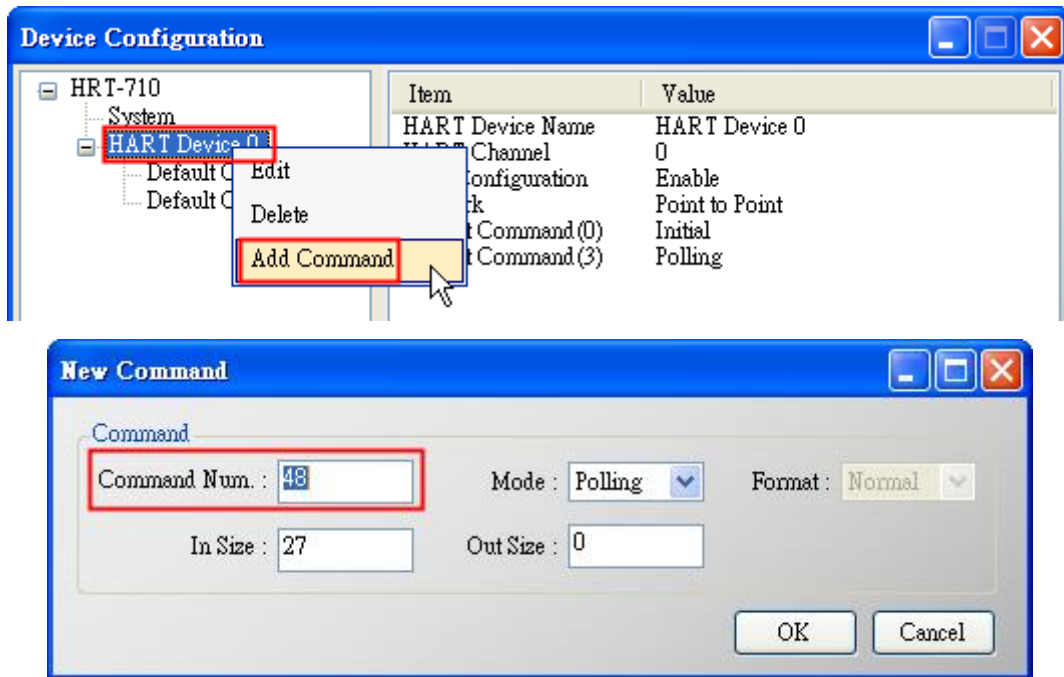

Figure 17-1 Add HART CMD 48 to HRT-711

2. In the “Device Configuration” screen, click the “Save to Device” button to save the settings to HRT-711.

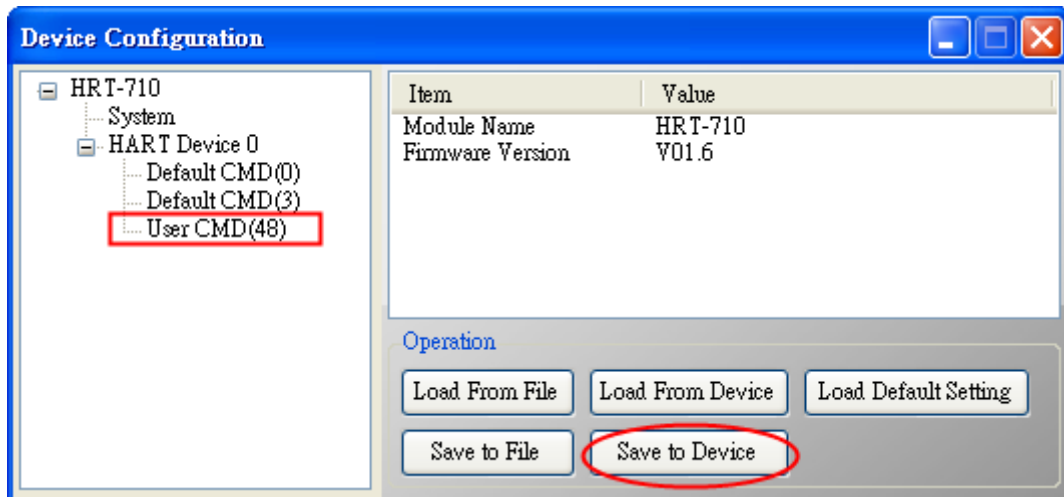

Figure 17-2 Save the settings to HRT-711

3. Get HART CMD48 data via Modbus.

(1) Open the “Address Map” screen and click the “UserCMD(48)” item. In the “Modbus AI” area, it will show the Modbus data address of UserCMD(48) with blue grid.

=> The response data length of HART CMD 48 will be 27Bytes (ResCode(2) and

ResData(25)). Therefore, it will occupy 14 WORD Modbus address as below address 0~13.

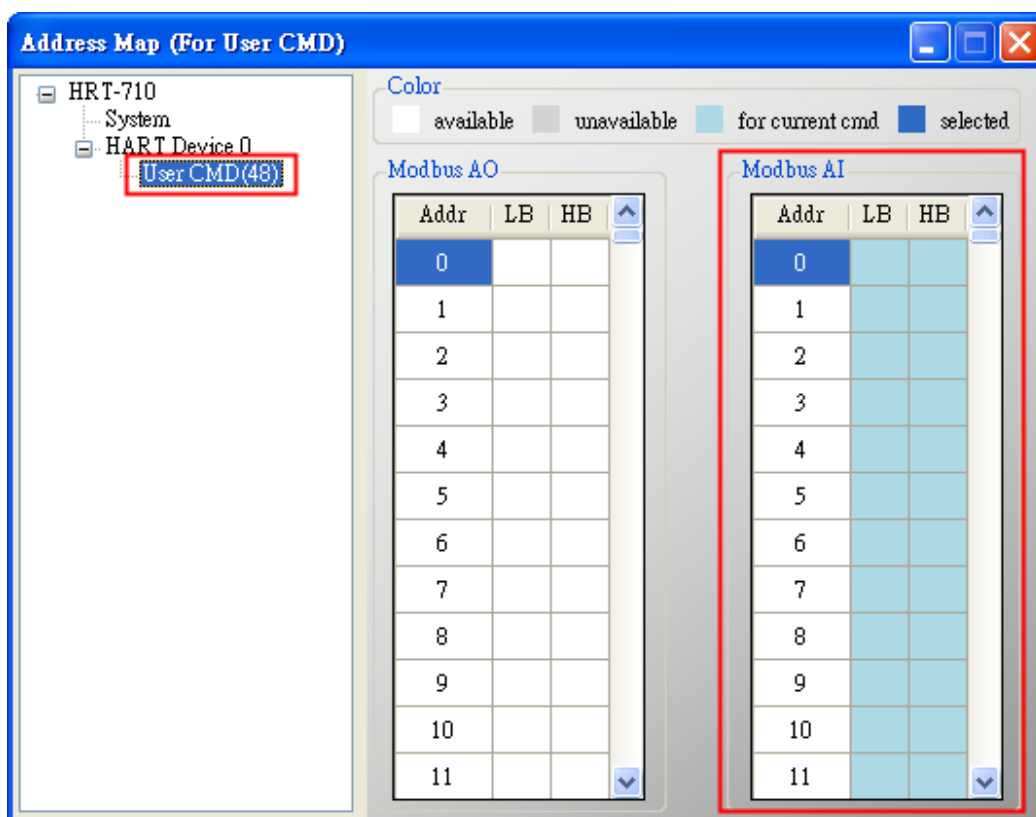

Figure 17-3 The modbus address occupied by UserCMD(48)

(2) Using Modbus Function Code 4 and address 0~13 to get the data of HART CMD 48.

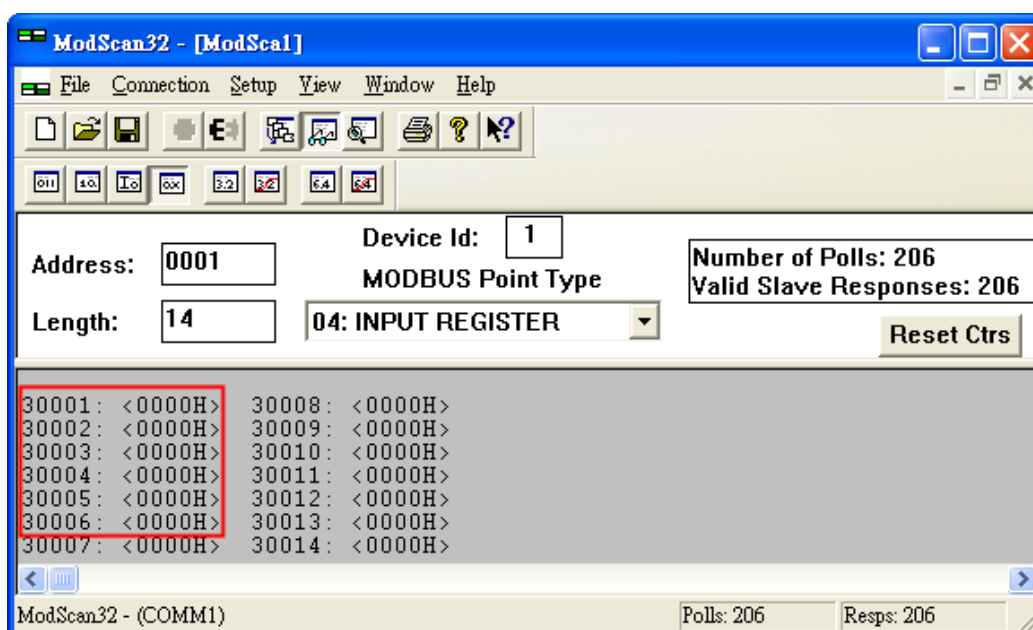

Figure 17-4 Get the HART CMD 48 data by using “ModScan”

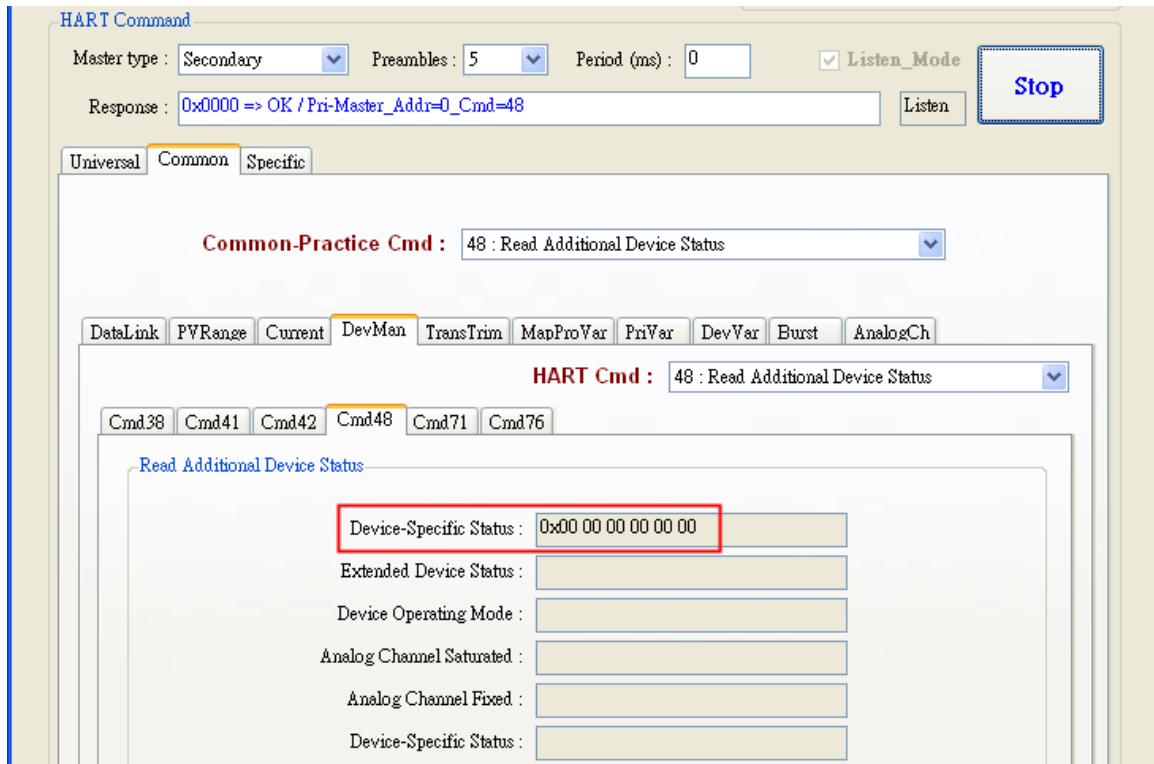

Figure 17-5 Get the HART CMD 48 data by using “HC\_Tool (HART Master)”

## Q18 : How to send HART “Burst Mode” CMD? (CMD108/109)

A18: (2017/01/09)

1. The below is the description for HART burst command function.

(1) HART CMD 108 (Write Burst Mode Command Number)

=>Used to set the response HART command no. when HART device burst mode is enabled.

(2) HART CMD 109 (Burst Mode Control)

=>Used to set HART device burst mode enabled or disabled.

2. Add HART CMD 108 and 109 to HRT-711

(1) In the “**Device Configuration**” page, click the right button of mouse on the “**HART Device 0**” item and choose the “**Add Command**” option.

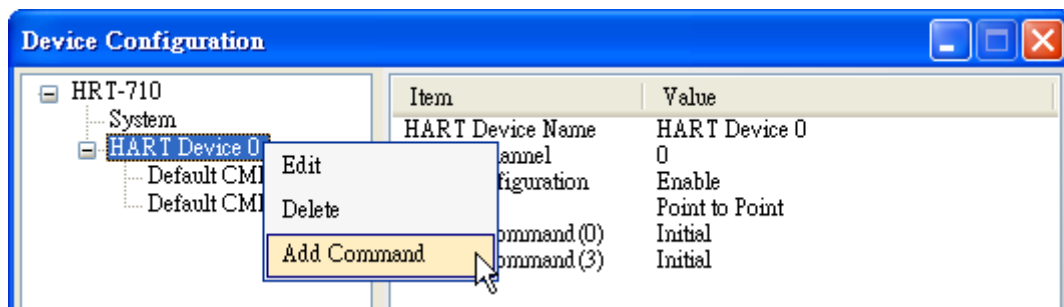

(2)[1] Input the value “**108**” in the “**Command Num**” field and choose the “**Manual**” option in the “**Mode**” field. Click the “**OK**” button to add the HART command 108 (Now the User Command Index is 0)

[2] Input the value “**109**” in the “**Command Num**” field and choose the “**Manual**” option in the “**Mode**” field. Click the “**OK**” button to add the HART command 109 (Now the User Command Index is 1)

[3] Click the “**Save to Device**” button to save the current settings to HRT-711.

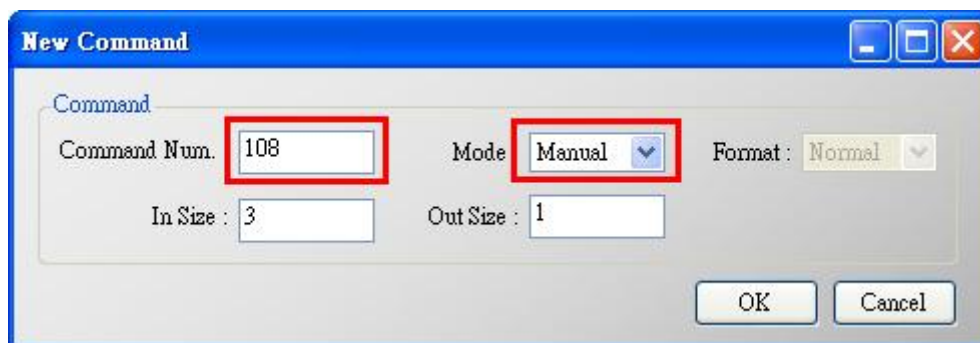

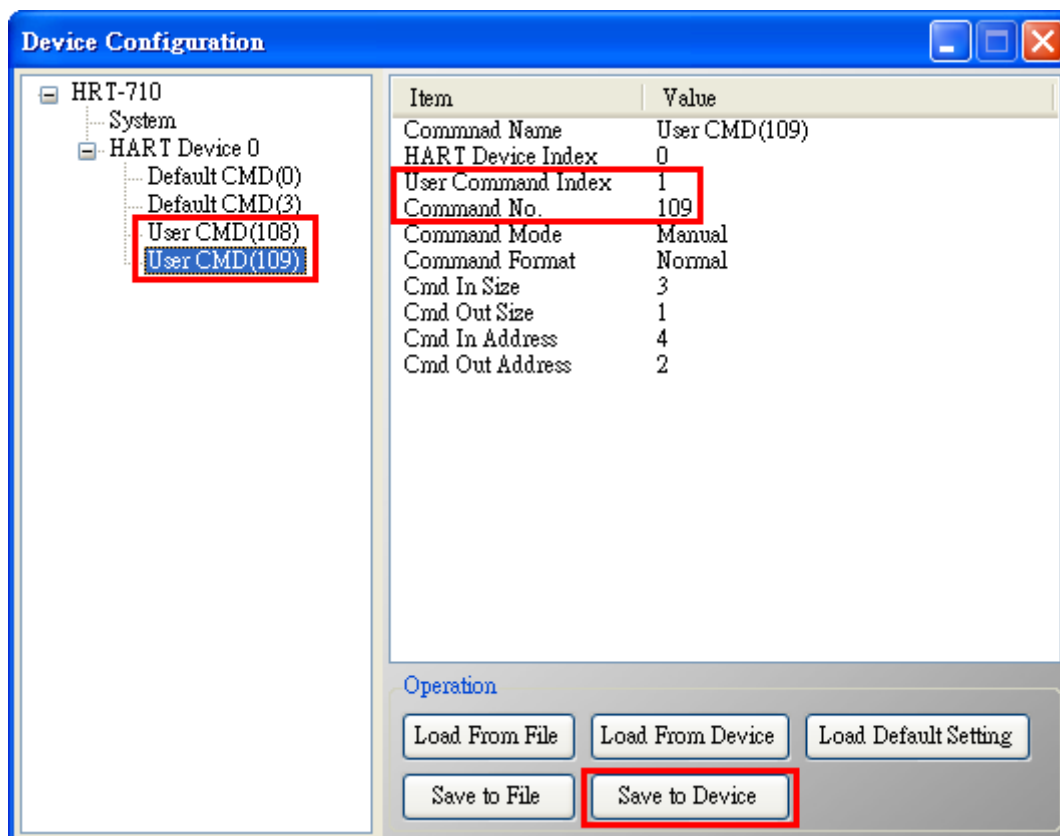
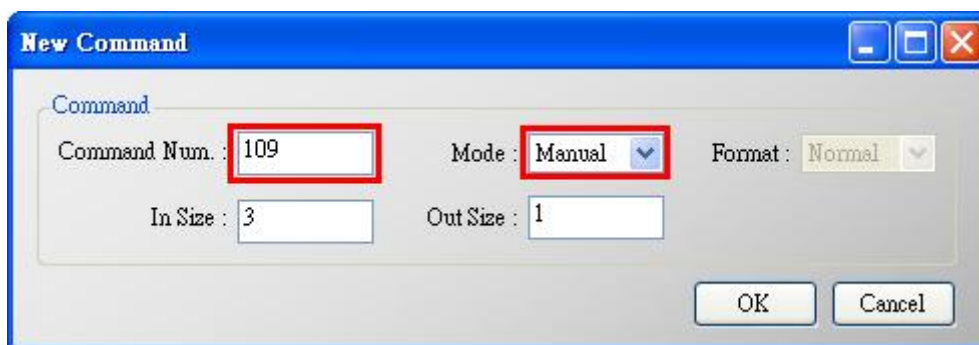

### 3. Set the value for the HART CMD 108. (HART CMD 108 sent not yet)

(1) There are one byte parameter in HART CMD 108.

(Ex: **The writing value 3(0x03)**=> It means that when HART device is in the burst mode, HART CMD 3 data will be sent from HART device automatically and periodically.

(2) Modbus command for the function is as below.

=> 01 06 00 00 03 00 89 3A

(3) After sending the above Modbus command, users can check if these values have been set successfully via HG\_Tool..

[1] In the “**Device Information**” page, click the right button of mouse on the “**User CMD(108)**” item and choose the “**Advanced operation**” option.

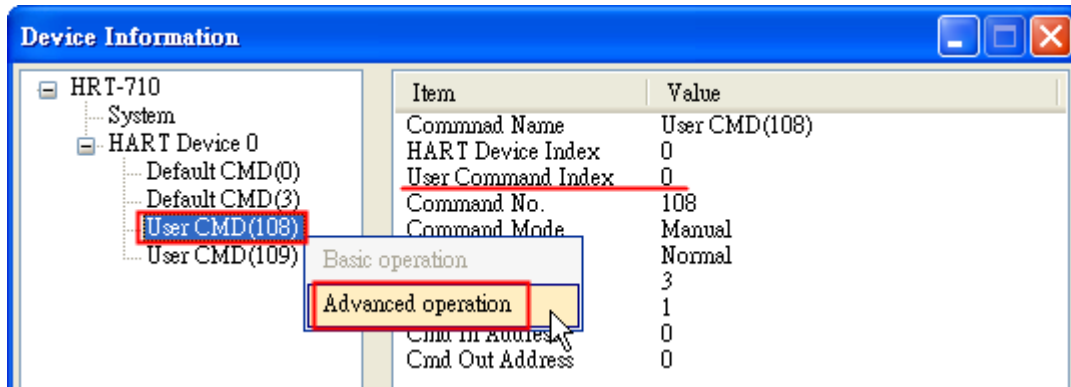

[2] In the “I/O Data” page, click the “Update” button and it will show the value for sending of UserCMD in the corresponding byte address in the “Output Data” area. Users can see the value of “3” been set successfully.

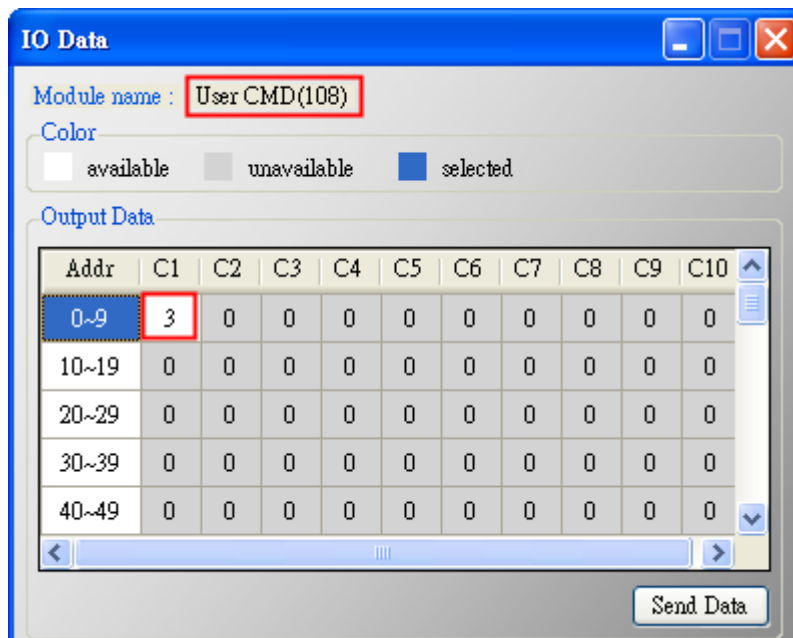

#### 4. Trig the HRT-711 to send the UserCMD0 (HART command 108)

(1) Stop the original HART polling command and send the UserCMD0.

The Modbus command will be as below.

=> 01 06 **01 F5** **00 00** 98 04

=> 01 06 **01 F6** **01 00** 69 94

[1] **00** : Stop all the original HART polling command.

[2] **00** : Set the UserCMD no. for sending.

[3] **01** : Trig to send the UserCMD and it needs the different value every time.

(Ex: the next value will be 2, 3, 4 ...)

=> Now the UserCMD0 (HART command 108) has been sent.

#### 5. Set the value for the HART CMD 109. (HART CMD 109 sent not yet)



(1) There are one byte parameter in HART CMD 109.

[1] **The writing value 1(0x01)**=> It means HART device burst mode will be enabled.

[2] **The writing value 0(0x00)**=> It means HART device burst mode will be disabled.

(2) Modbus command for the function is as below.

[1] Enable Burst mode => 01 06 00 01 01 00 D9 9A

[2] Disable Burst mode => 01 06 00 01 00 00 D8 0A

(3) After sending the above Modbus command, users can check if these values have been set successfully via HG\_Tool..

[1] In the “**Device Information**” page, click the right button of mouse on the “**User CMD(109)**” item and choose the “**Advanced operation**” option.

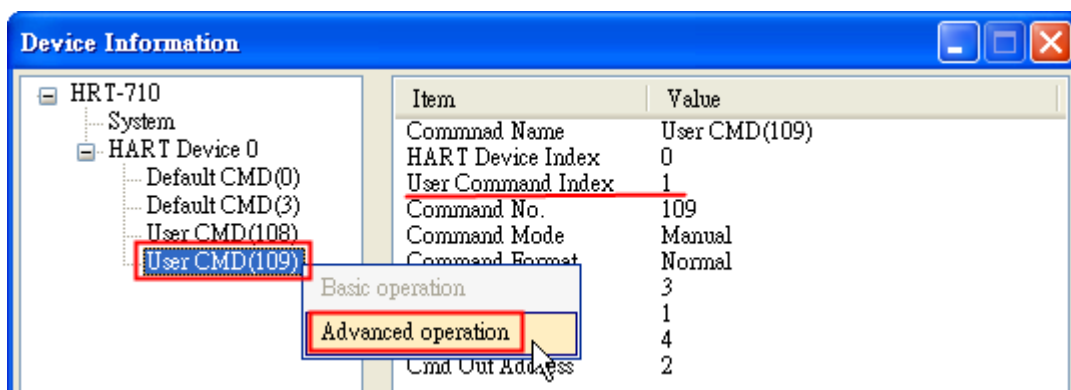

[2] In the “**I/O Data**” page, click the “**Update**” button and it will show the value for sending of UserCMD in the corresponding byte address in the “**Output Data**” area. Users can see the value of “1” been set successfully.

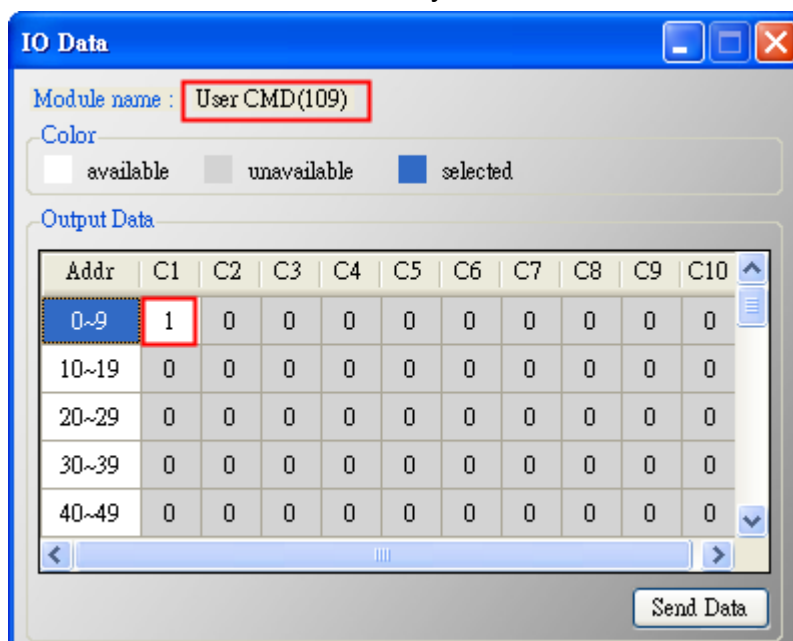

## 6. Trig the HRT-711 to send the UserCMD1 (HART command 109)

**(1) Stop the original HART polling command and send the UserCMD1.**

The Modbus command will be as below.

=> 01 06 **01 F5** **00 00** 98 04

=> 01 06 **01 F6** **02 01** A8 A4

[1] **00** : Stop all the original HART polling command.

[2] **01** : Set the UserCMD no. for sending.

[3] **02** : Trig to send the UserCMD and it needs the different value every time.

(Ex: the next value will be 3, 4, 5 ...)

=> Now the UserCMD1 (HART command 109) has been sent.

**7. Recover the original HART polling command.**

(1) The Modbus command will be as below.

=> 01 06 **01 F5** **01 00** 99 94

[1] **01** : recover all the original HART polling command.

**Q19 : How to reset totalizer value by sending Device-Specific command?**

A19: (2017/11/28)

**[ Case Example]**

1. A user wants to use HRT-711 to reset the totalizer value from instrument KROHNE ESK4 by sending HART command 137.

[ Solution ]

1. Users must get the HART Device-Specific command first. The HART command No.137 format of KROHNE ESK4

**Command #137: Reset Totalizer**

**Request Data Bytes**

Byte	Format	Description
None		Resets the Totalizer Value to Zero

**Response Data Bytes**

Byte	Format	Description
None		

Figure 19-1 CMD137's frame format of KROHNE ESK

2. Add UserCMD CMD137 of ROHNE ESK4 to HRT-711:

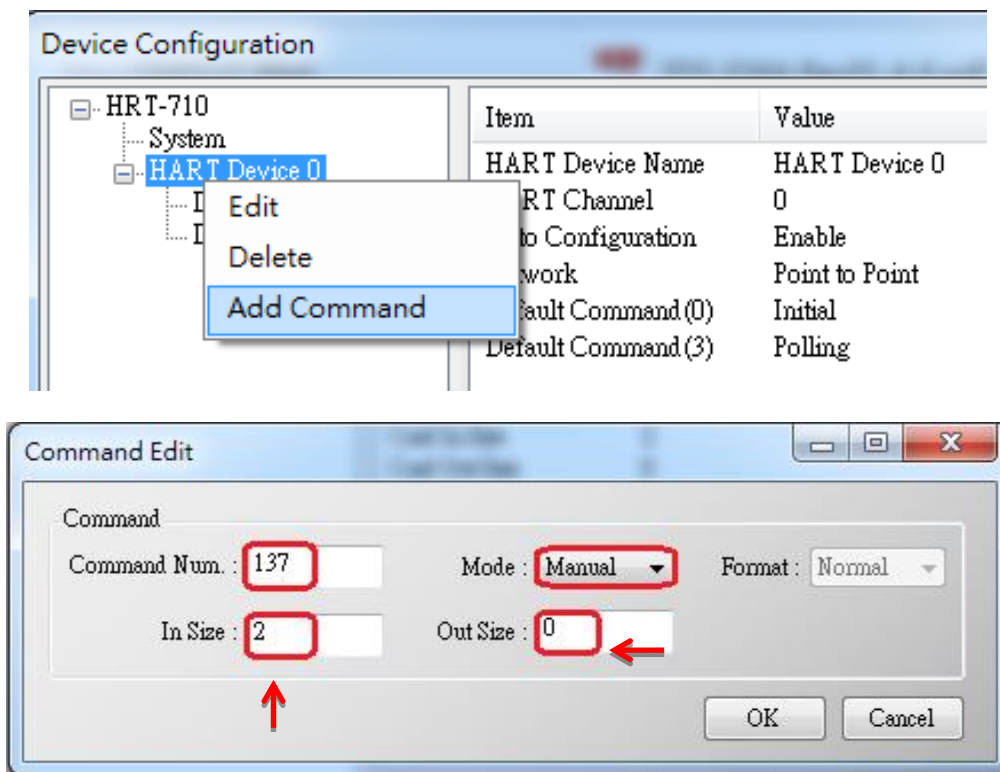

Figure19-2 Add HART command 137 to HRT-711

3. After finished settings, click **“Save to Device”** button in Device Configuration to save all the settings.

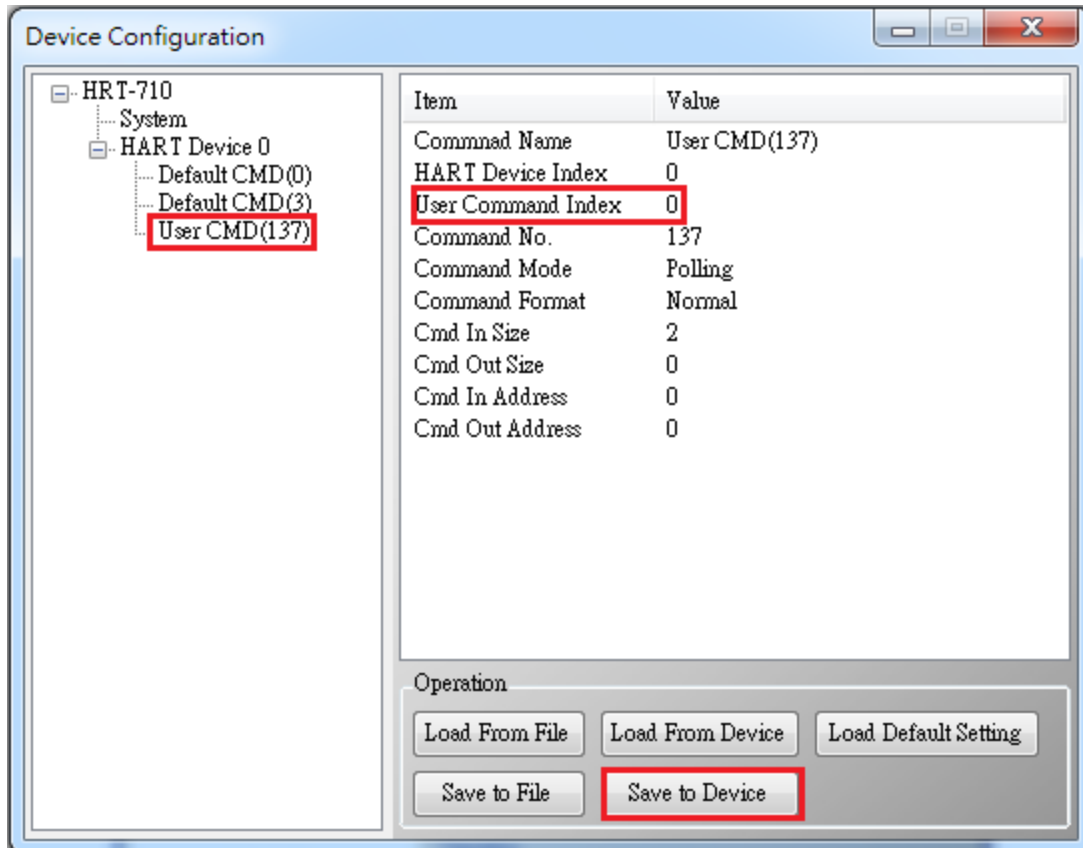

Figure19-3 Save settings to HRT-711

4. Trig the HRT-711 to send UserCMD0 (HART command 137) .

(1) Stop the original HART polling command and send UserCMD0

(2) The Modbus command will be as below:

=> 01 06 01 F5 00 00 98 04

=> 01 10 01 F6 01 00 69 94

[1] 00 : Stop all the original HART polling command

[2] 00 : Set the no. of UserCMD for sending

[3] 01 : Trig to send the UserCMD and it needs the different value every time. (Ex: the next value will be 2,3,4 ...)

=> Now the UserCMD0 (HART command 137)

5. Recover the original HART polling command

(1) The Modbus command will be as below:

=> 01 06 01 F5 01 00 99 94

[1] 01 : recover all the original HART polling command

## Q20 : How to read total-flow data from flow-meter?

A20: (2018/04/10)

### [ Case Example ]

1. A user wants to use HRT-711 to read the total-flow value from SIEMENS instrument FUS060.

### [ Solution ]

1. According to the user manual of FUS060, device specific CMD130 is for reading total value and there are 3 values with 4 bytes length each, so the total data length is  $3 \times 4 = 12$  bytes

HART command list					
Command #	Name	Operation	Parameters	Type	Bytes
130	read_HART_dynamic_variables	read	func6_TOT_total_value, func7_TOT_total_value, func3_TOT_total_value	FLOAT FLOAT FLOAT	4 4 4

Adding device specific command to HG\_Tool requires to enter in and out data bytes, the in and out data here should include a 2 bytes response code.

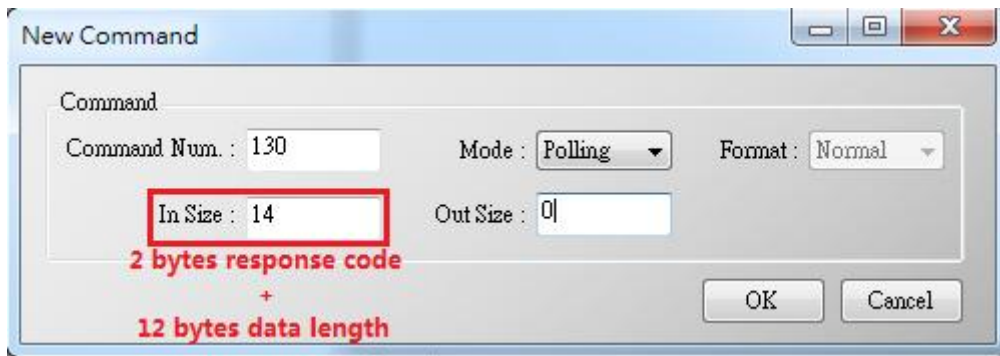

2. After adding the CMD130, please check whether it works properly by checking from the Advanced operation from Device Information and analyse with the IEEE754 Converter provided by HG\_Tool Format Translation function.

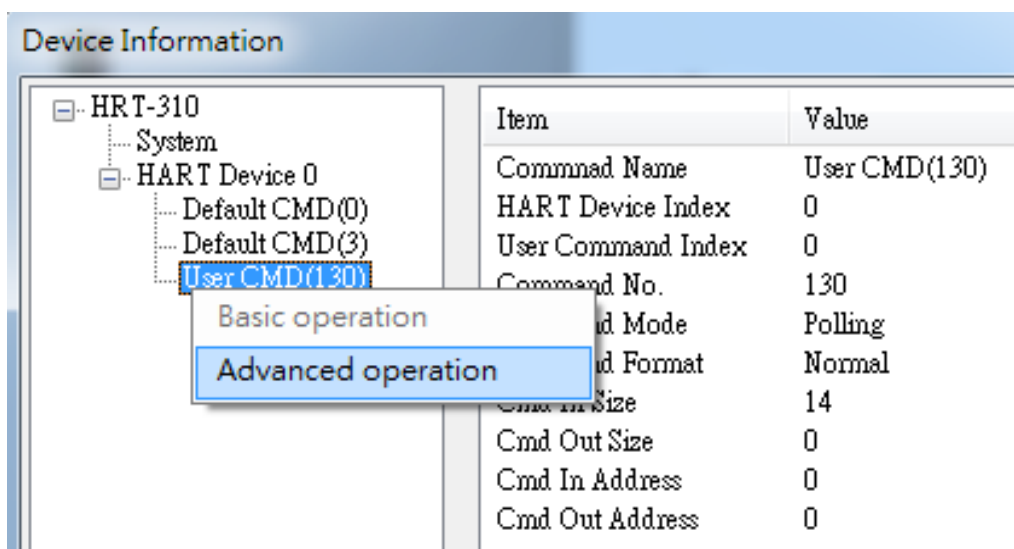

3. After making sure the settings in HG\_Tool are all properly done, Modbus tools can be used to testify. ModScan has been used as an example here:

(1) HRT-711 records device specific command data from Modbus address 0~499

MB_Addr (HEX)	MB_Addr (Decimal)	Description
[ User CMD Data ]		
0~1F3	0~499	"User CMD" data

(2) Because ModScan is a 1-based (instead of starting from 0) software, so the address should be from 1~500

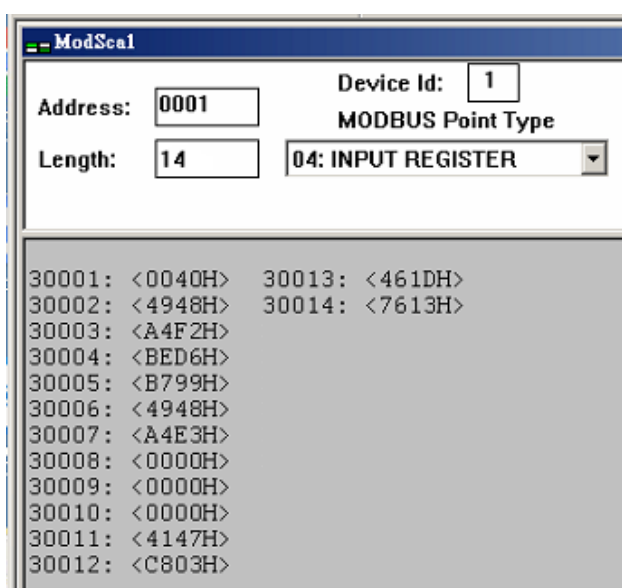

(3) The first 2 Bytes are response code, so the data starts from address 2

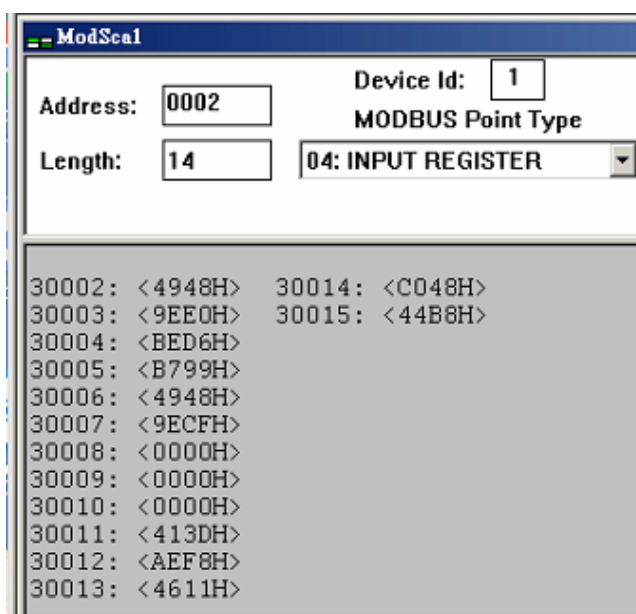

## Q21 : HART communication update period calculation and adjustment

A21: (2018/08/02)

### 1. HART communications update period calculation :

Settings shown as below will be used as example: (HRT-310 with 2 HART devices)

1) HRT-310 parameters setting as below:

- [1] HRT-310 sends CMD0 and CMD3 to both HART instruments
- [2] CMD0 sets as Init mode, CMD3 sets as Polling mode
- [3] Cmd Interval sets as 1000 ms

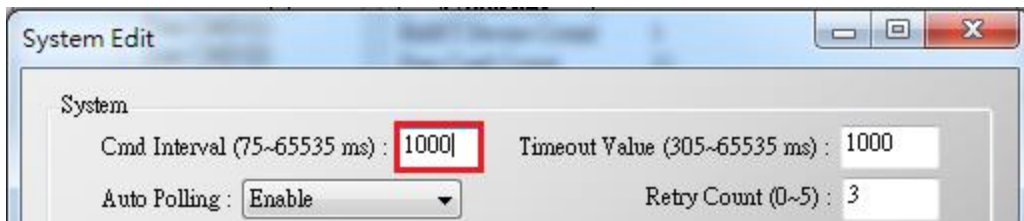
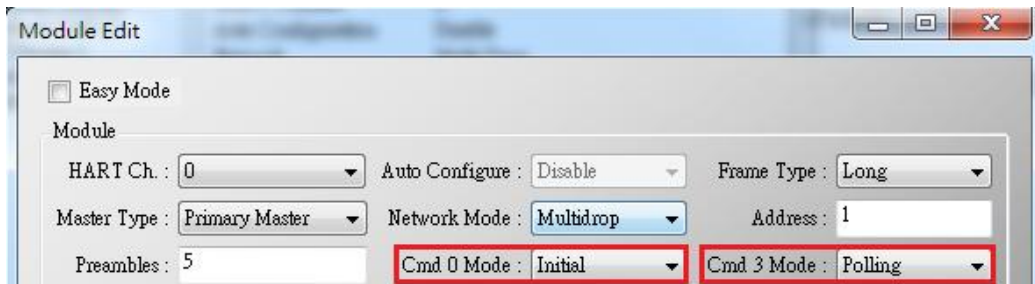
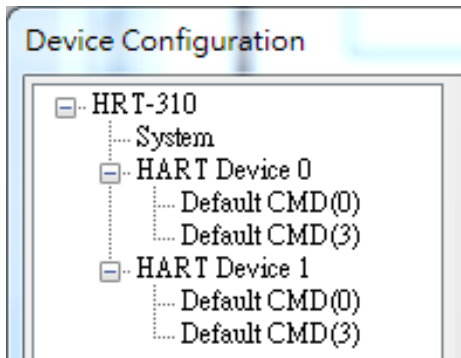

2) The HRT-310's update period of all HART instruments' data is:

[1] Init commands (CMD0) communication time:

HRT-310 will send CMD0 to short frame address from 0 and stops until finds all devices. As the settings shown above, Device 0 and 1 has short frame address of 1 and 2, so CMD0 will be sent **3** times. Communication time is:

$$3 * 1000 = 3000 \text{ ms}$$

**Note:** Because CMD0 is Init command, it will only be executed when HRT-310 booted up, so it **does not affect HART communication update period**.

[2] Polling commands (e.g. CMD3) communication time:

HRT-310 will send Polling commands to each HART device sequentially. As the settings shown above, there are total of 2 HART instruments and only 1 Polling command (CMD3) is required to be sent for each device. Therefore communication time is:

$$2(\text{Devices}) * 1(\text{Polling CMD}) * 1000(\text{ms}) = 2000 \text{ ms}$$

**=>Conclusion: HART communication update period is the total time taken to send all Polling commands. So the update period here is 2000 ms**

## 2. HART communication update period adjustment :

### 1) Shorten HART communication update period

[1] Delete unnecessary HART polling commands

The default settings of HART gateway contains 1 HART device and multiple HART commands, shown as below

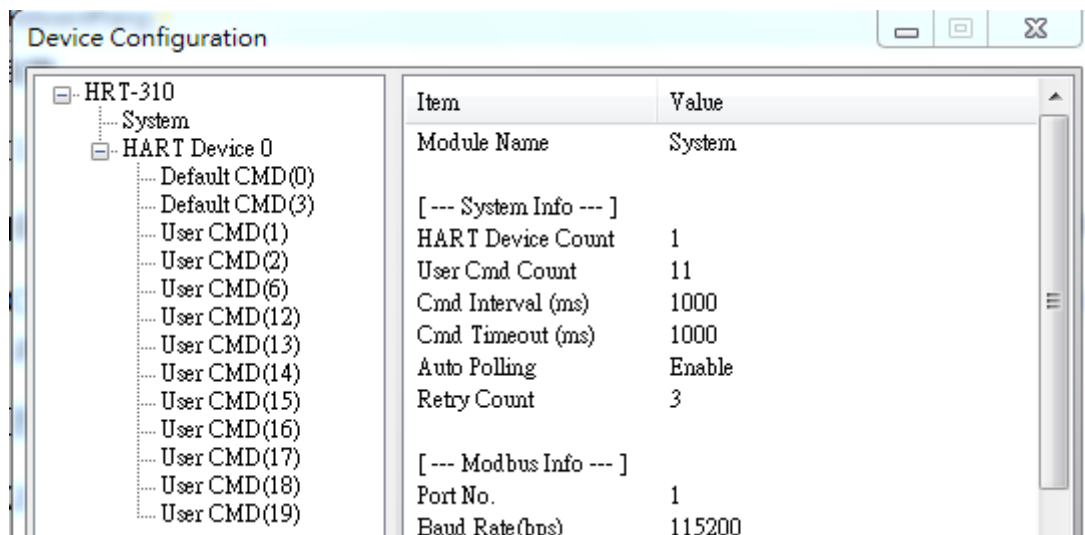

In order to shorten HART device update period, it is recommended to delete the whole device and then add a new device setting. (Refer to FAQ Q01)

[2] Shorten HART command interval

Right click on the System item and select Edit, reduce the time for Cmd Interval, 500 ms is suggested to be the minimum command interval.

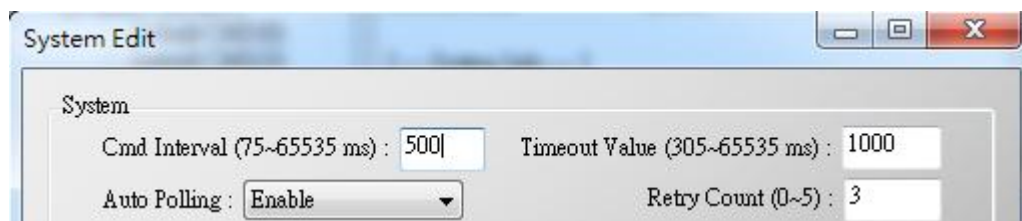

2) The communication update period for HRT-310 to collect all devices data is:

$$2(\text{Devices}) * 1(\text{Polling CMD}) * 500(\text{ms}) = 1000 \text{ ms}$$



**Q22 : Integrate HART communication to traditional AI structure**

A22: (2018/10/29)

**1. The existing AI loop system:**

1) Device analog signal collected by AI module

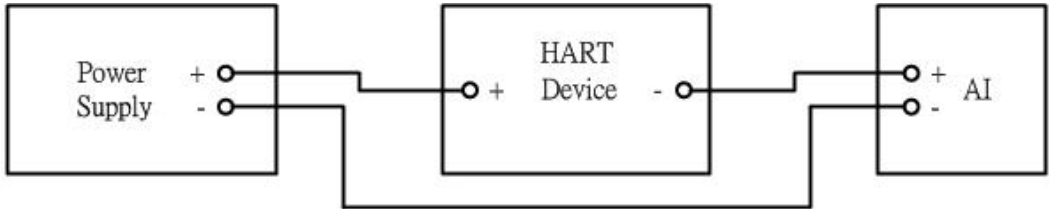

**2. Integrating HART communication to collect more HART device information:**

1) Integrating HART Gateway to the existing system, new system as follow:

2) Switch off HART Gateway built-in resistor and parallel connecting to AI module

=> Additional HART communication function integrated to existing system

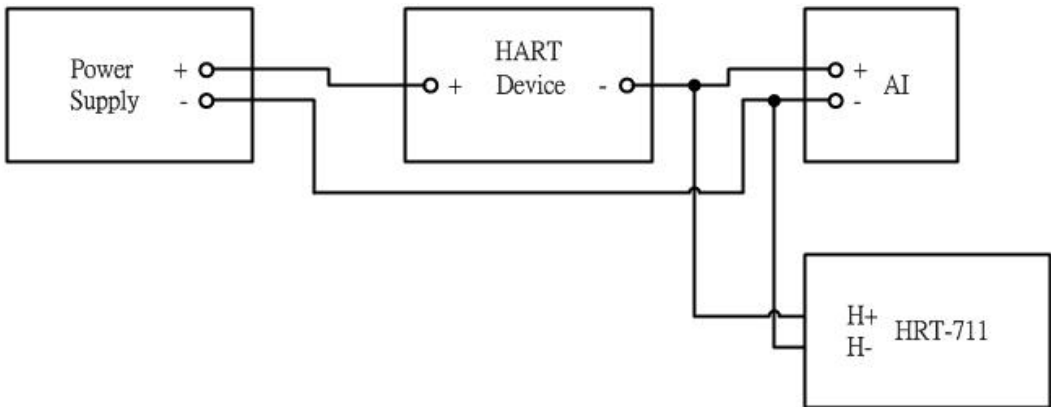

**3. If AI readings of the initial system get disturbed after HART gateway added:**

1) Using HART Filter (HRT-370) to split HART digital signal and AI analog signal

=> new system as follow:

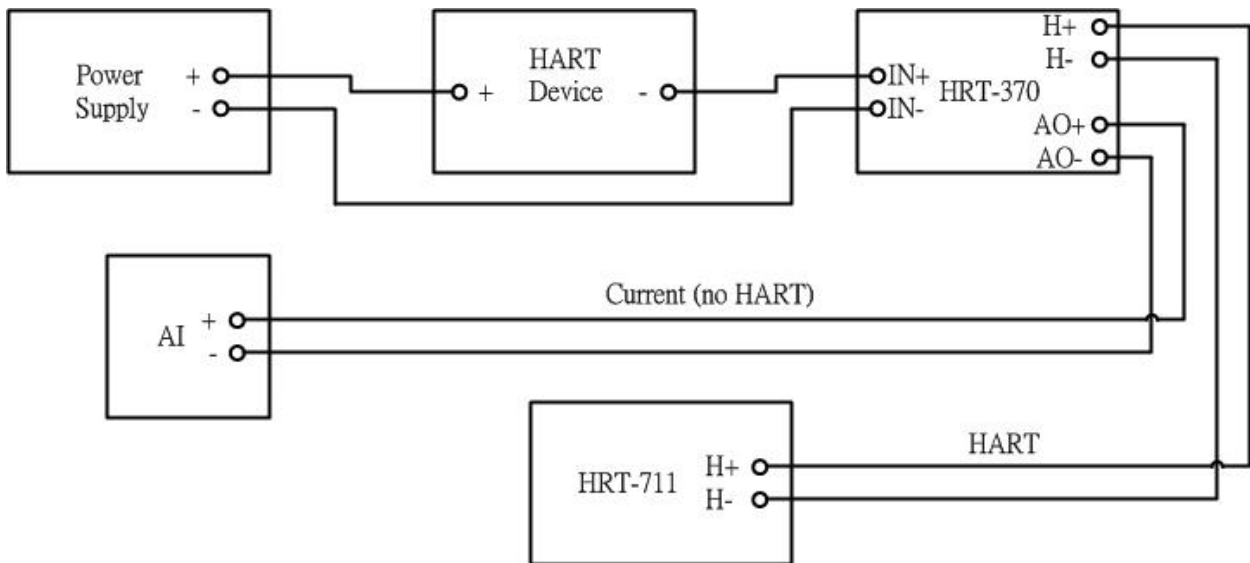

## Q23 : HART Multi-drop mode precautions

A23: (2018/10/29)

### Hardware:

#### 1. HART devices address must set in between 1~15 and no repeated.

1) Please first set the HART address for each HART device one by one, then adding all to the HART Multi-drop loop.

#### 2. Wiring for HART Multi-drop mode is as follow:

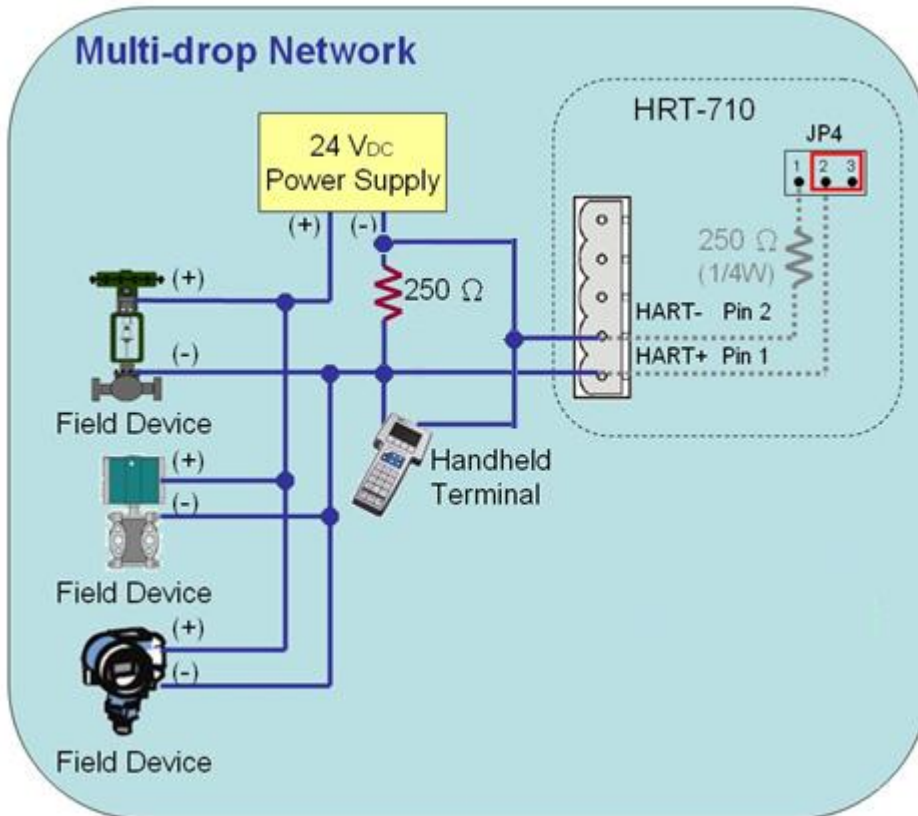

#### 3. Start building structure from 2 HART devices

1) To avoid situation that when error occurs and not knowing how to debug, it is recommended to start building structure with only 2 devices and adding 1 more device at a time if no error occurs until all devices been added.

#### 4. Make sure the HART loop resistance is 250 Ω

1) Please measure if the resistance is around 250 Ω in between Module's (ex. HRT-710) HART+ / HART-

#### 5. Choose HART loop resistor when connecting to 7 or more HART devices

1) HRT-710 and HRT-711 with hardware version earlier than V1.30:

When connecting more than 7 HART devices, built-in resistor (250 Ω , 1/4W) may be burned, therefore suggesting use an external resistor (250 Ω , 1W)

2) HRT-710 and HRT-711 with hardware version from V1.30 and later:

Module upgraded built-in resistor to 250 Ω (2W), therefore no need to worry

=> HRT-310 designed to use built-in resistor of 250 Ω (2W) at first place, therefore no need to worry about this issue

### 6. Check the voltage in between HART device (Be aware of voltage drop)

When connecting more HART devices, the voltage available between devices + / - drops and devices may not be able to turned on. Example as follow:

In Multi-drop mode, every HART device provides extra 4mA to HART loop, if customer uses a 24V power supply, the voltage between HART devices should be as follow:

#### 1) Connecting 1 HART device:

Loop current: **4mA**; Loop resistance: **250 Ω** => Voltage drop between resistor: **1V**;  
therefore voltage left for devices: **24V-1V=23V**

#### 2) Connecting 10 HART devices:

Loop current: **40mA**; Loop resistance: **250 Ω** => Voltage drop between resistor: **10V**;  
therefore voltage left for devices: **24V-10V=14V**

#### 3) Connecting 11 HART devices:

Loop current: **44mA**; Loop resistance: **250 Ω** => Voltage drop between resistor: **11V**;  
therefore voltage left for devices: **24V-1V=13V**

(If device needs 14V or above voltage in order to be turned on, then HART communication failed)

### Software (HG\_Tool):

#### 1. Set Module Address between 1~15 in Module Configuration

The screenshot shows the 'Module Configuration' window in HG\_Tool. It contains several configuration options:

- HART Ch.: 0
- Auto Configure: Disable
- Frame Type: Long
- Master Type: Primary Master
- Network Mode: Multidrop
- Address: 1 (highlighted with a red box)
- Preambles: 5
- Cmd 0 Mode: Initial
- Cmd 3 Mode: Polling

## Q24 : HART communication distance issues

A24: (2019/02/23)

1. When installing HART network, communication distance needs to be considered. Please refer to below table for information about cable capacitance and length

No. Network Devices	Cable Capacitance – pf/ft (pf/m)			
	20 pf/ft (65 pf/m)	30 pf/ft (95 pf/m)	50 pf/ft (160 pf/m)	70 pf/ft (225 pf/m)
1	9,000 ft (2,769 m)	6,500 ft (2,000 m)	4,200 ft (1,292 m)	3,200 ft (985 m)
5	8,000 ft (2,462 m)	5,900 ft (1,815 m)	3,700 ft (1,138 m)	2,900 ft (892 m)
10	7,000 ft (2,154 m)	5,200 ft (1,600 m)	3,300 ft (1,015 m)	2,500 ft (769 m)
15	6,000 ft (1,846 m)	4,600 ft (1,415 m)	2,900 ft (892 m)	2,300 ft (708 m)

Source:

[https://www.fieldcommgroup.org/sites/default/files/technologies/hart/ApplicationGuide\\_r7.1.pdf](https://www.fieldcommgroup.org/sites/default/files/technologies/hart/ApplicationGuide_r7.1.pdf)

2. If communication distance needs to be extended, please try following methods:

### (1) Use Fiber to extend HART communication distance

HRT-227CS is HART to Single-Mode Fiber converter, specially designed to extend HART communication distance.

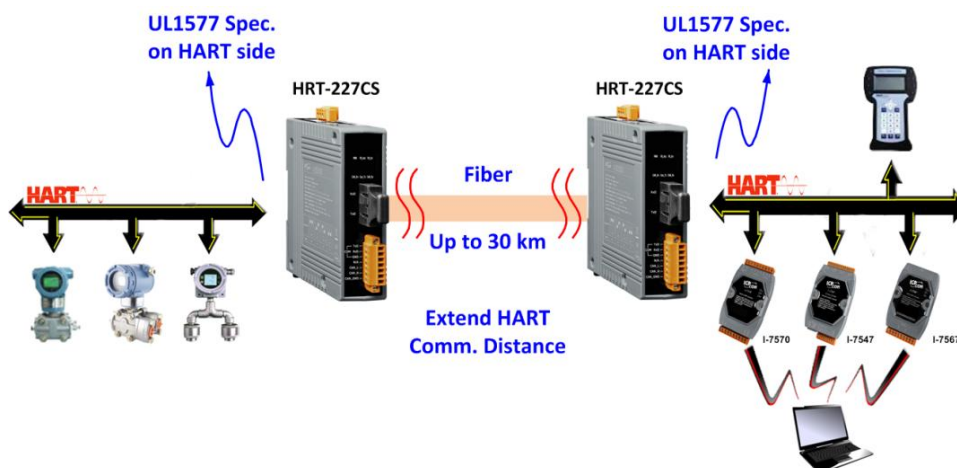

For more information, please refer to:

**HRT-227CS** user manual:

[ftp://ftp.icpdas.com/pub/cd/fieldbus\\_cd/hart/converter/hrt-227cs/manual/](ftp://ftp.icpdas.com/pub/cd/fieldbus_cd/hart/converter/hrt-227cs/manual/)

**(2) Use Fiber to extend RS-485 communication distance**

**I-2541** and **I-2542** series are RS-232/ 422/ 485 to Single-Mode Fiber converters, specially designed to extend Serial communication distance.

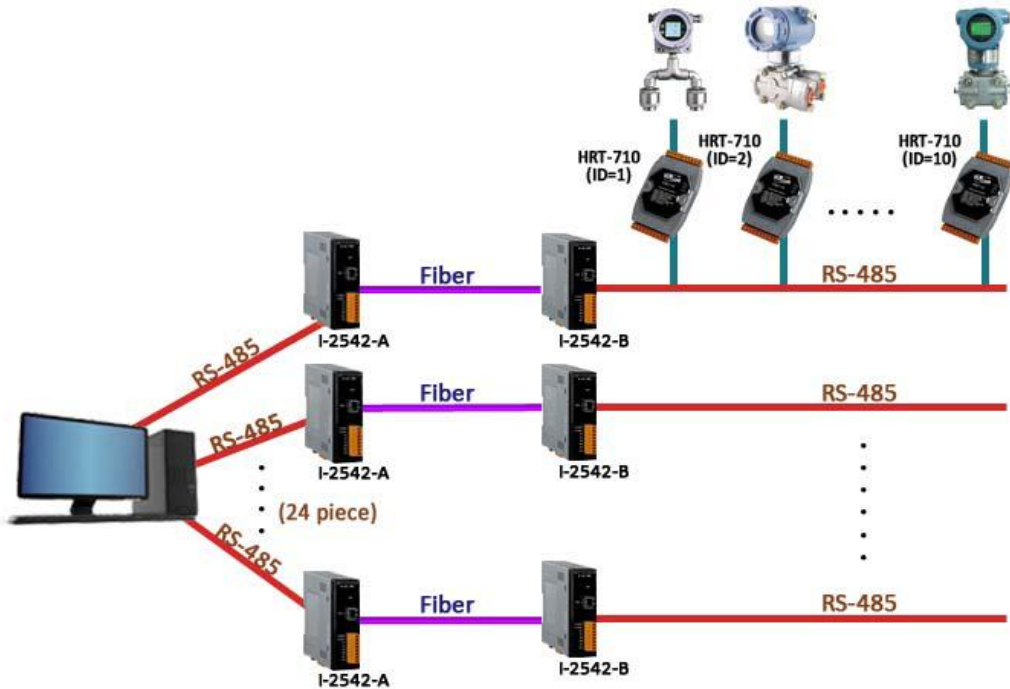

For more information, please refer to:

I-2541 user manual:

<http://www.icpdas.com/download/converter/manual/net-i2541.pdf>

I-2542 series user manual:

[http://www.icpdas.com/root/product/solutions/datasheet/industrial\\_communication/I-2542-Release%20Note\\_V1%2000.pdf](http://www.icpdas.com/root/product/solutions/datasheet/industrial_communication/I-2542-Release%20Note_V1%2000.pdf)

**(3) Use Fiber to extend Ethernet communication distance**

ICP DAS provides various Ethernet to Fiber switch, below is an example of using **NS-205F** and **NS-209F** Ethernet switch to extend communication distance

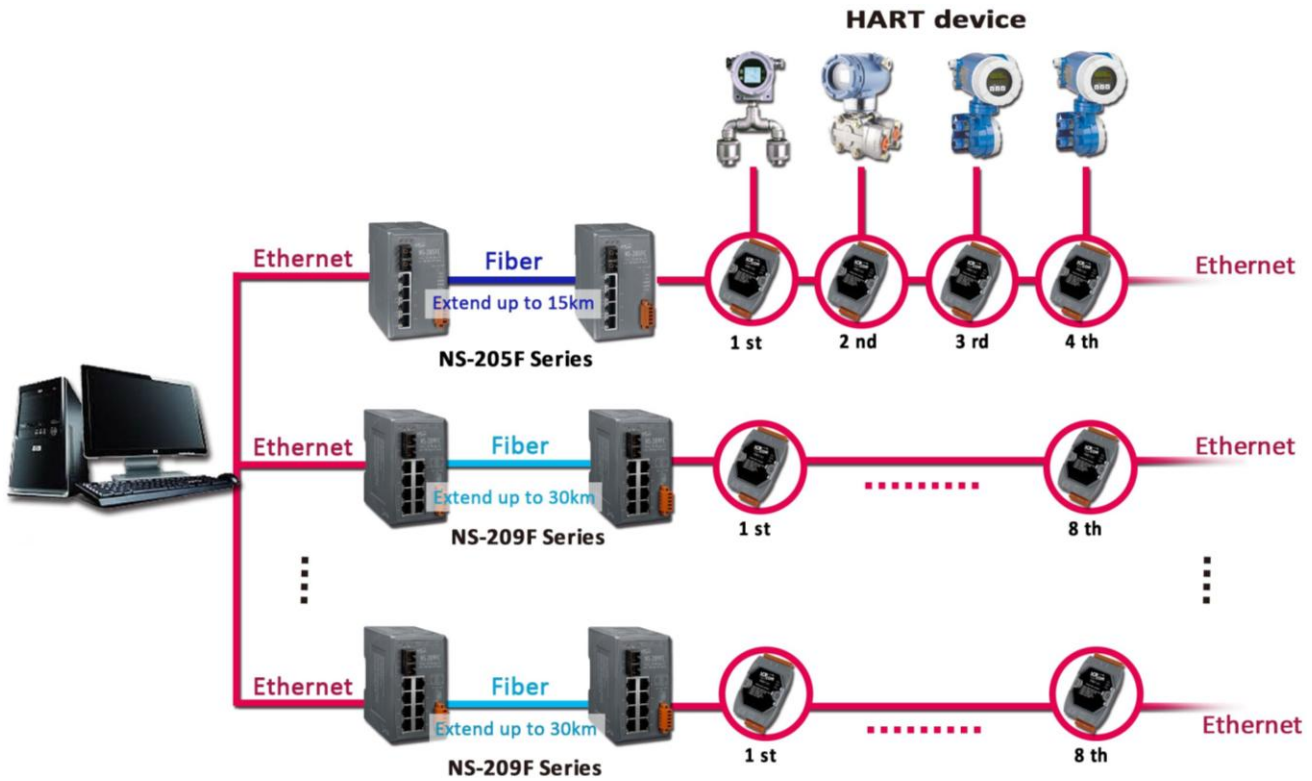

To find suitable Ethernet & Fiber switch, please check from:

[http://www.icpdas.com/root/product/solutions/industrial\\_ethernet\\_switch/switch\\_selection.html#a](http://www.icpdas.com/root/product/solutions/industrial_ethernet_switch/switch_selection.html#a)

#### (4) Use Ethernet Switch to extend Ethernet communication distance

Similar to previous method, instead of using Fiber, simple Ethernet switch can also extend the communication distance

To find suitable Ethernet switch, please check from:

[http://www.icpdas.com/root/product/solutions/industrial\\_ethernet\\_switch/switch\\_selection.html#a](http://www.icpdas.com/root/product/solutions/industrial_ethernet_switch/switch_selection.html#a)

# Q25 : Using Through Mode of HG\_Tool to Stop Burst Mode of HART Device

A25: (2019/08/28)

1. Run the HG\_Tool and connect to HRT-711.
  - (1) Disable all the Polling command.

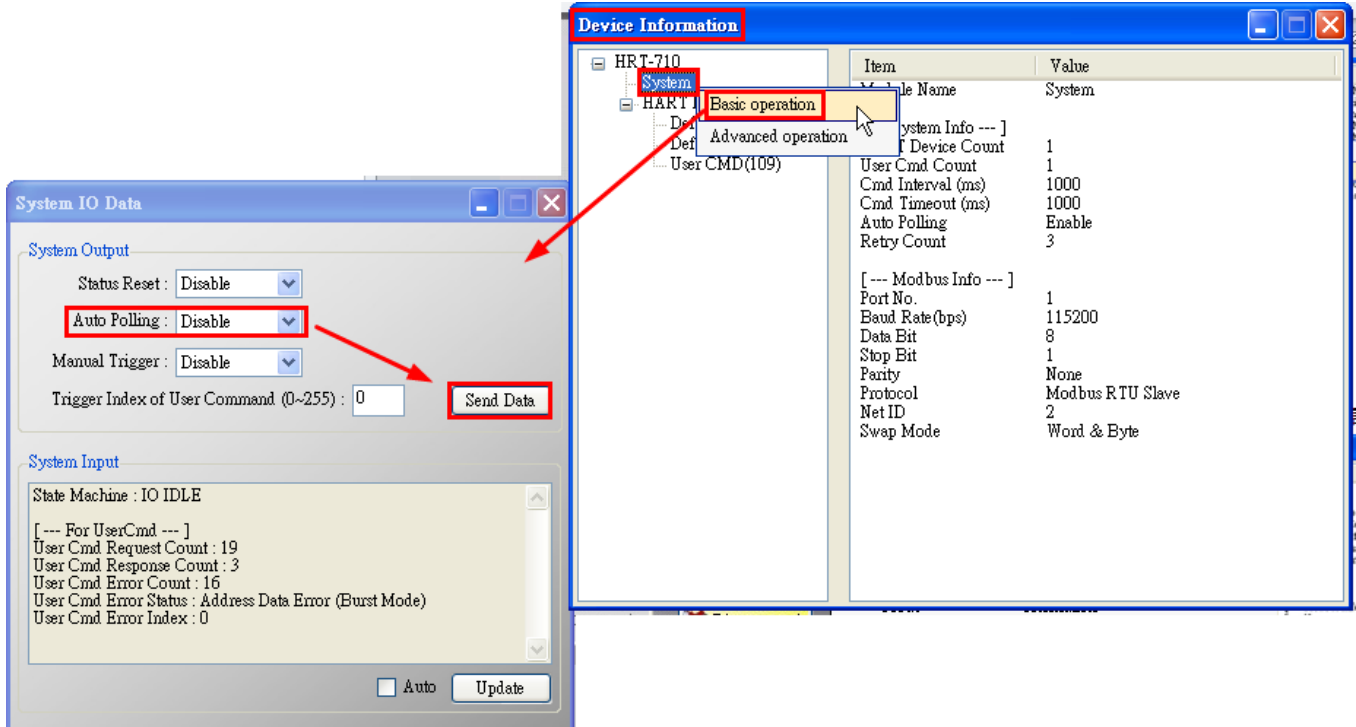

(2) Open the “Through Mode” and send HART CMD0 to get the “Long Frame Address” of HART device.

[1] HART CMD0 : FF FF FF FF FF 02 80 00 00

[2] Long Frame Address : 1A 0B 50 EB CD (As the below figure)



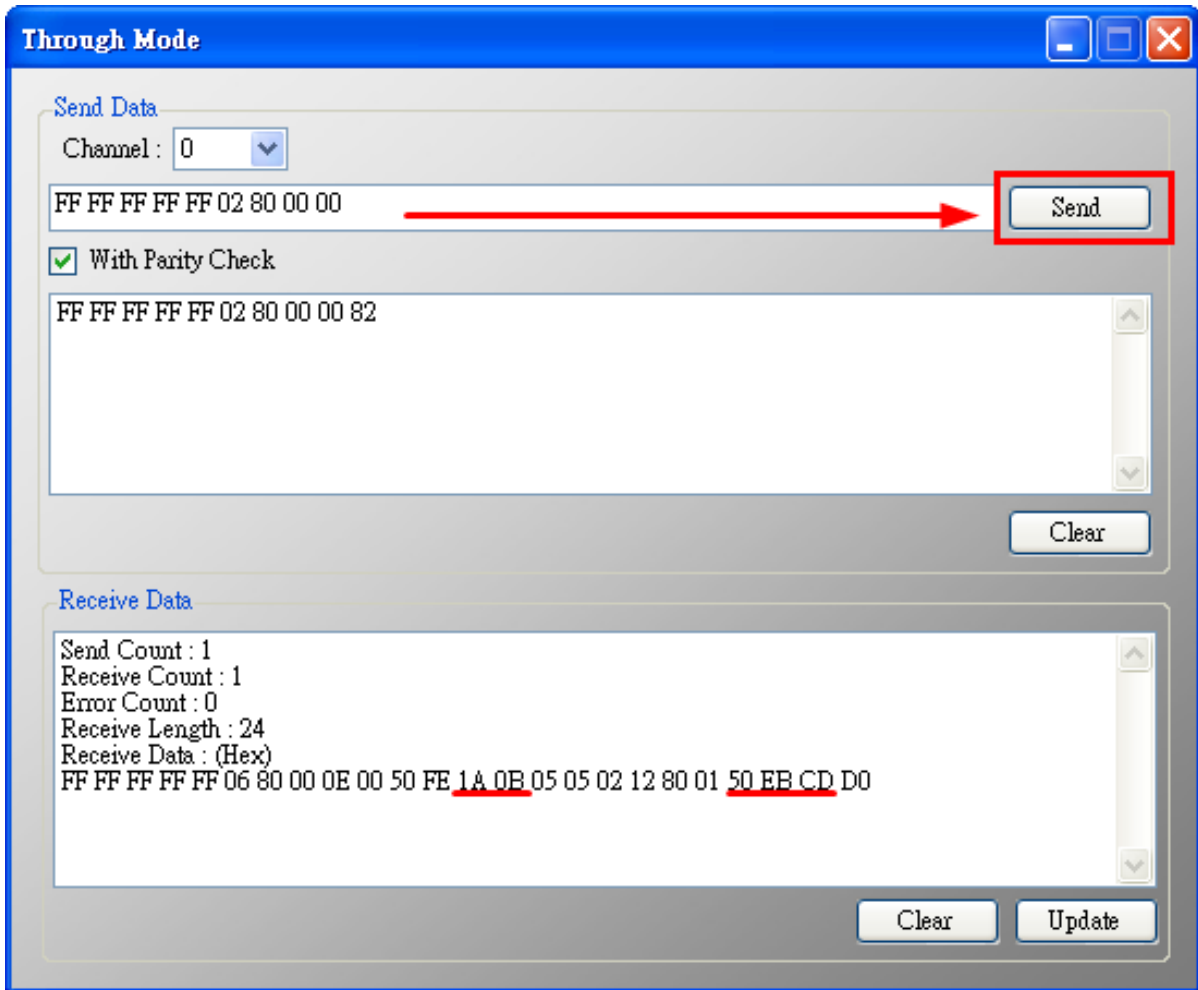

(3) Configure HART command 109 and send it to disable the burst mode of HART device.

[1] HART CMD 109 => Ex : **FF FF FF FF FF 82 DA 0B 50 EB CD 6D 01 00**

<1> FF FF FF FF FF : Preamble

<2> **82** : Delimiter (0x02 need to add **0x80** = 0x82)

<3> **DA 0B 50 EB CD** : Long Frame Address (Different from every HART device)  
(0x1A need to add **0xC0** = 0xDA)

<4> 6D : HART command no. (0x6D = 109)

<5> 01 : Byte Count (HART command parameter byte)

<6> 00 : Data (HART command parameter content. 00 for )

## Q26 : How to use the In\_Offset field of the UserCMD ?

A25: (2020/08/19)

### [ Example ]

2. A user wants to use HRT-711 to read the float data from instrument Endress-Hauser

Promass F300 by sending HART command 158. (The float data doesn't arranged in two



WORD of Modbus address) ◦

[ Solution ]

3. Run the example, users need to update the firmware of HRT-711 to be v1.03 and use HG\_Tool\_v1.5.0.

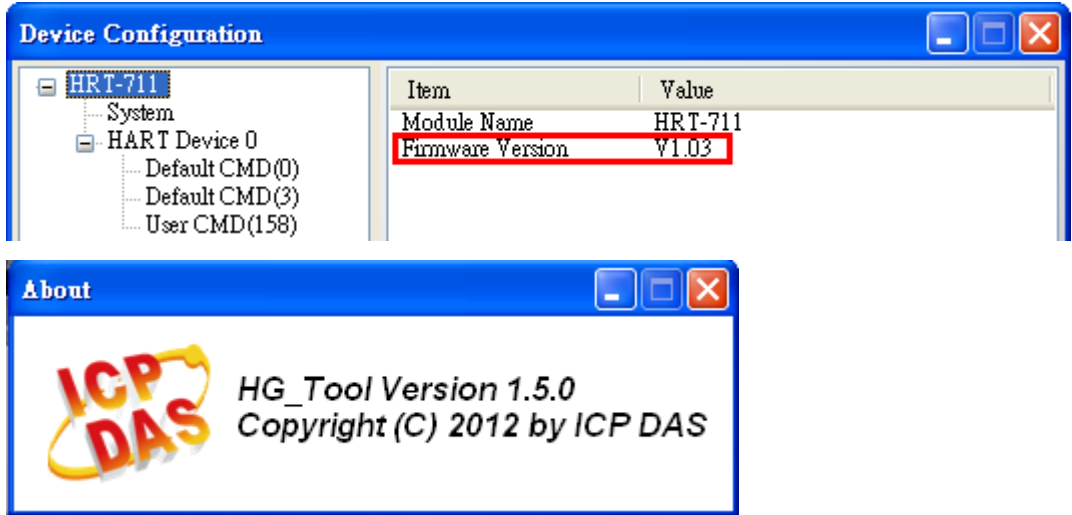

4. The format of HART command 158 is as below.

(1) The start byte of the response float data is in byte3.

Request Data Bytes		
Byte	Format	Description
0-1	Unsigned-16	Parameter HART Index
2	Unsigned-8	Parameter Instance

Response Data Bytes		
Byte	Format	Description
0-1	Unsigned-16	Parameter HART Index
2	Unsigned-8	Parameter Instance
3-n	Value	float data

Fig 26-1 HART 158 format of Endress-Hauser Promass F300

5. Add the UserCMD of HART command 158 to HRT-711.



(1) Owing to the start byte of the response float data is byte3, so in the "In\_Offset" field,

users can fill with 3 to ignore HART response data byte0, 1, and 2. Then the response float data can be shown in the Modbus address easily.

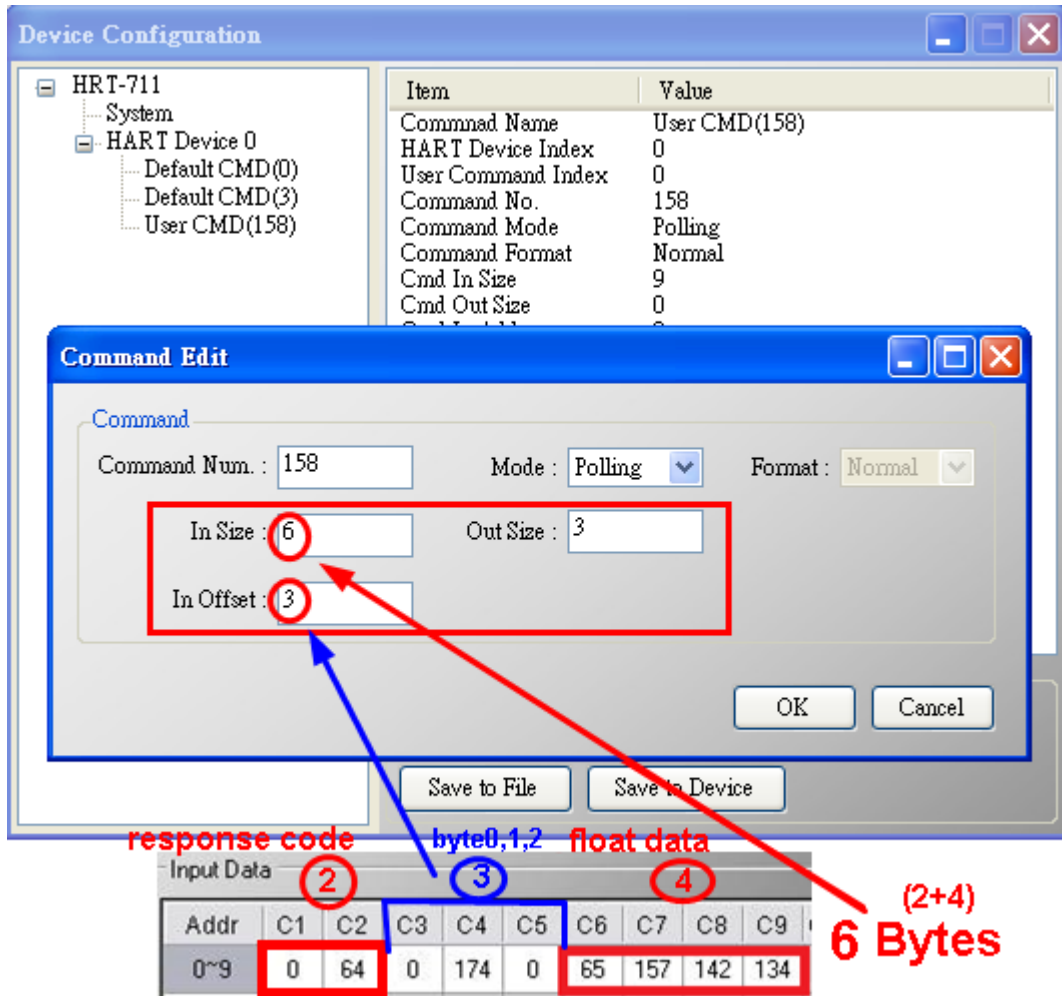
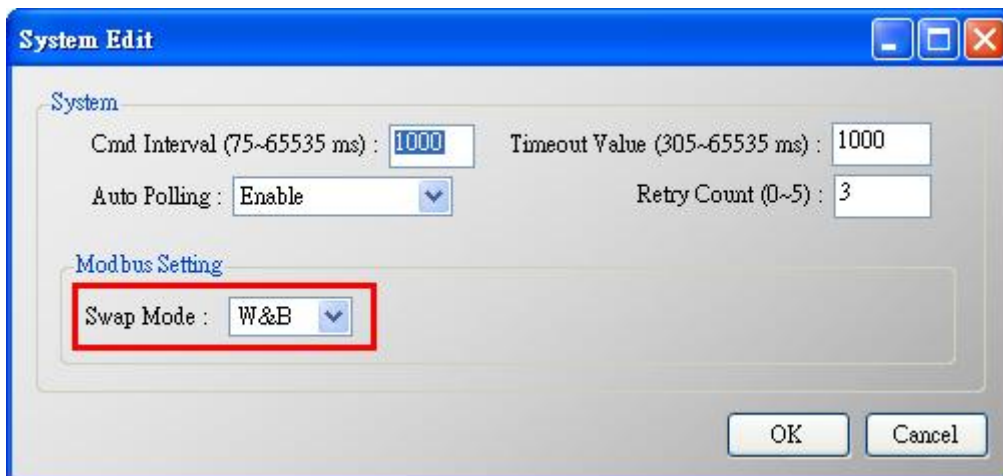

Fig 26-2 Add the UserCMD of HART command 158 to HRT-711

(2) In "System Edit" page, please set the "W&B" in the Swap Mode field.



6. After finished the settings, click "Save to Device" button in Device Configuration to save all the settings.

7. Trig the HRT-711 to send UserCMD0 (HART command 158). (refer to the steps of FAQ15)
8. Get the response data of HART command 158 via HG\_Tool.

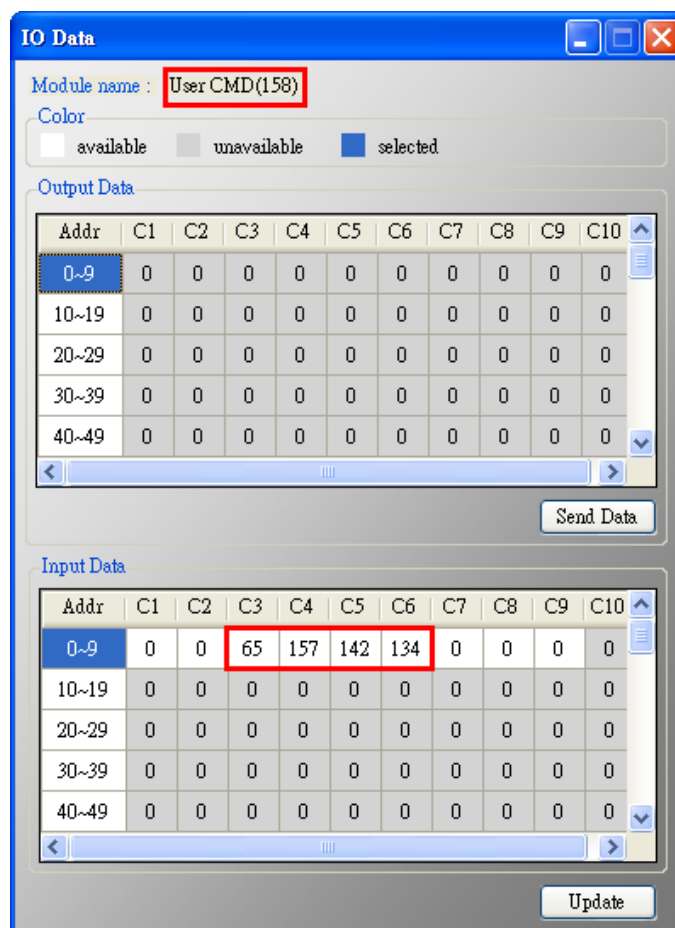
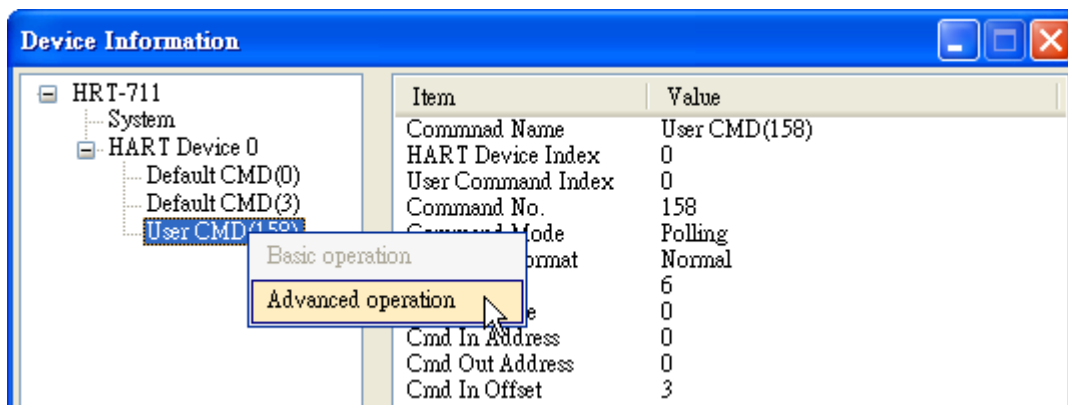

Fig 26-3 The response data of HART command 158

9. Get the response data of HART command 158 via modscan tool.
  - (1) The Modbus first WORD data: the response code of HART command 158.
  - (2) The Modbus second and third WORD data: the float data of HART command 158.

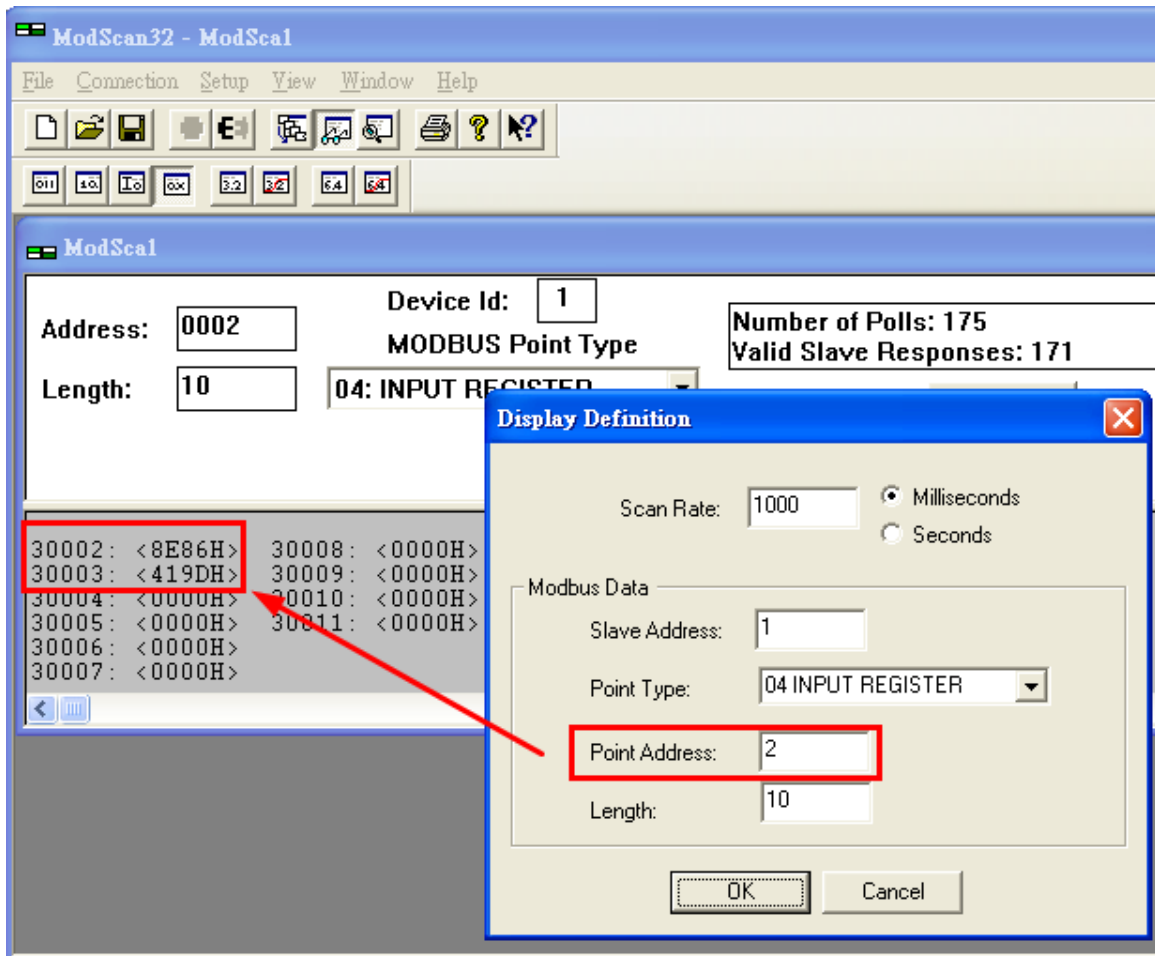

Fig 26-4 The response data of HART command 158 (Hex format)

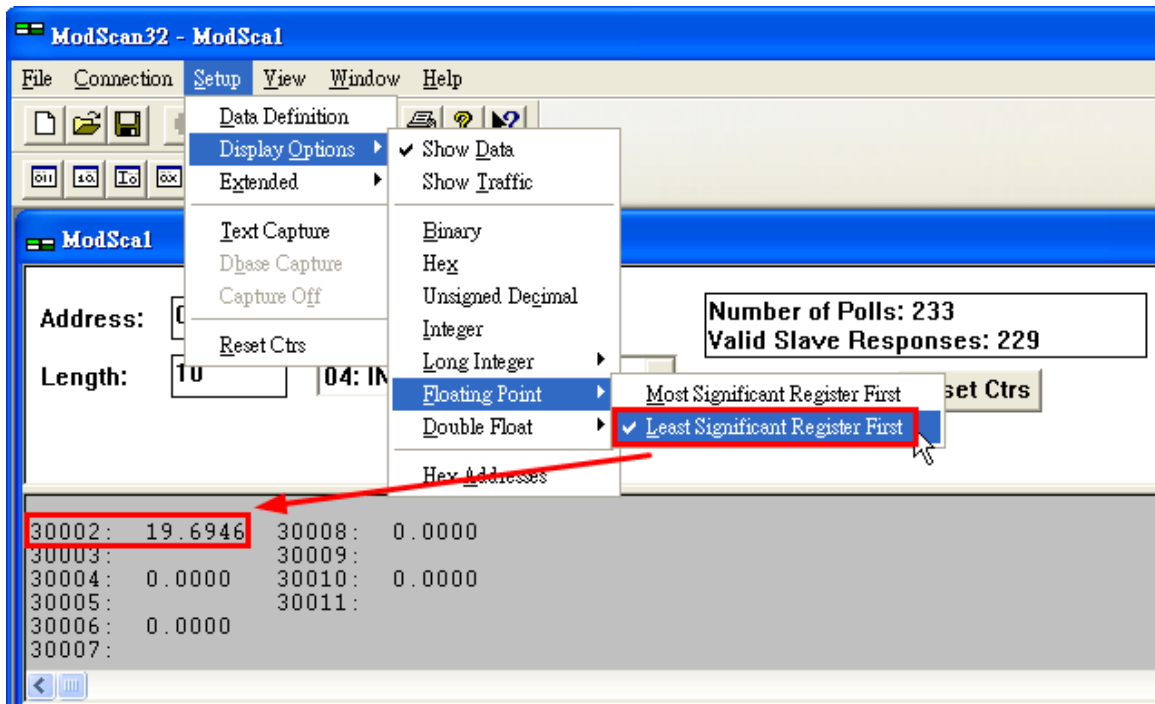

Fig 26-4 The response data of HART command 158 (float format)

## Q27: How to use “Listen Only” function to get HART data?

A27: (2020/08/20)

### [ Example ]

A user wants to get HART device data (like HART command3) in another PC via Modbus/TCP via the original HART network without interfering the original HART communication.

### [ Solution ]

1. The HART “Listen Only” function had been supported in HRT-711 firmware v1.03. It means that HRT-711 doesn't send any HART command and just receive HART communication and then can get HART device data via Modbus.

### 2. Example-1: ( There is just only one HART device in HART network )

(1) Using HDS (HART Device Simulator) software to set HART command 3 and 158 data as the below figure for HART device.

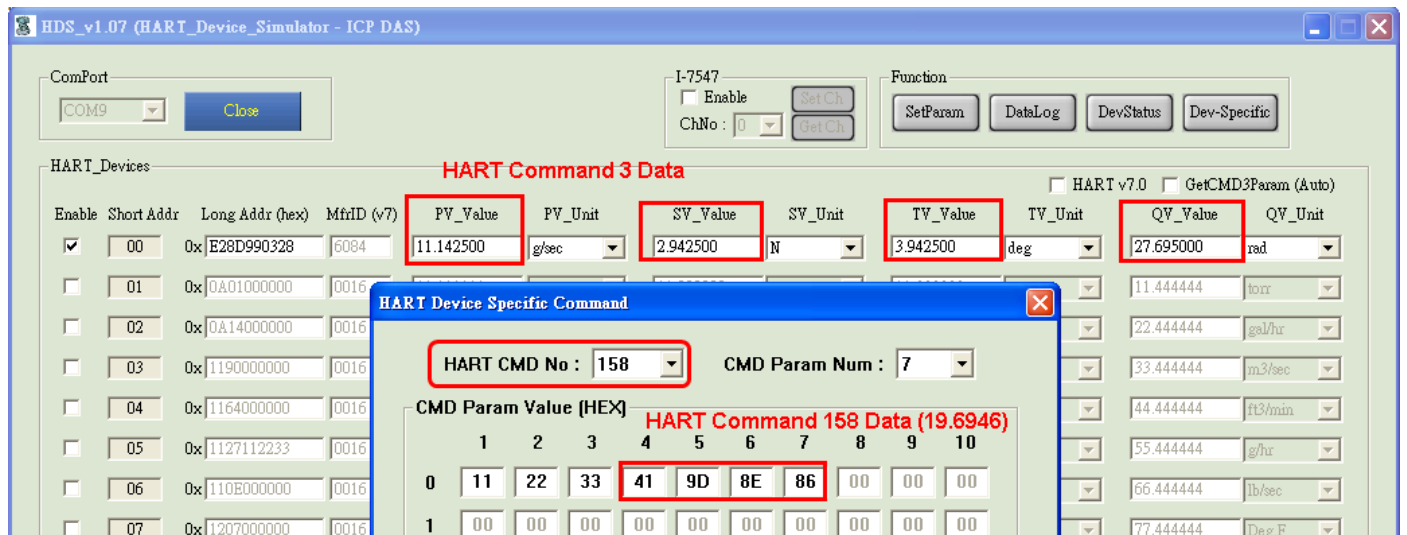

Fig 27-1 Set HART command 3 and 158 data in the HDS

(2) Add HART command 3 and 158 to HRT-711.

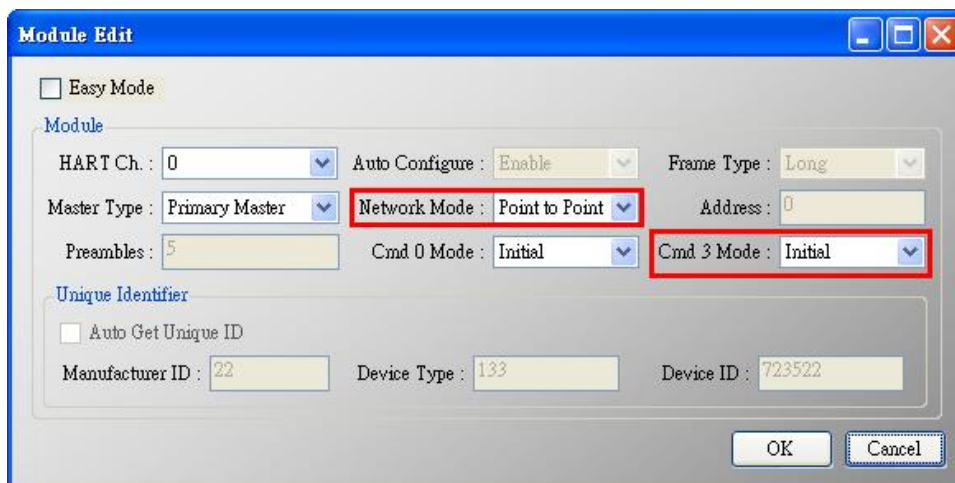

Fig 27-2 HART command 3 setting

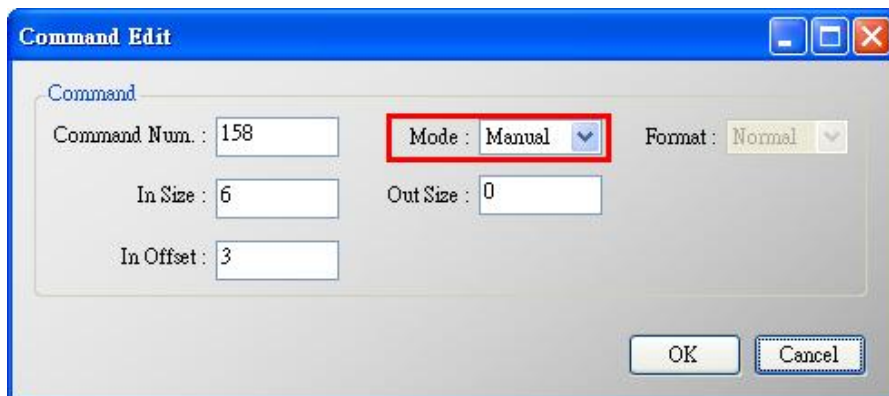

Fig 27-3 Add HART command 158 (UserCMD)

(2) In the "System Edit" page, Set "Auto Polling" to be "Disable"(HRT-711 will not send HART command) and set the "Swap Mode" to be "W&B".

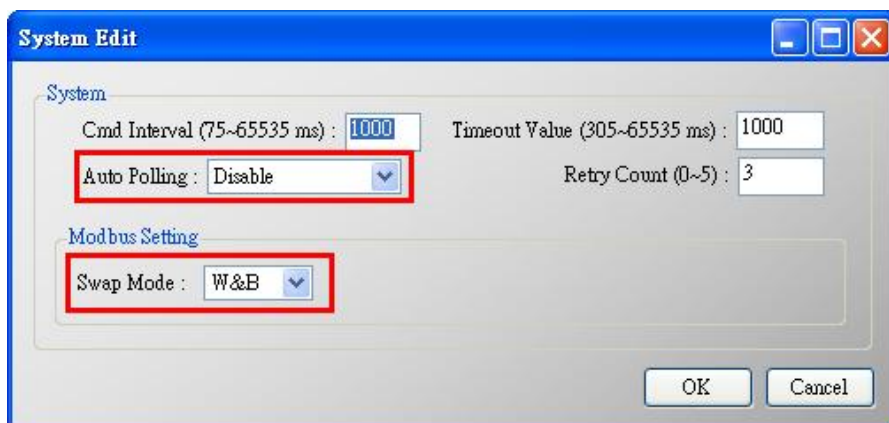

Fig 27-4 Set "Auto Polling" to be "Disable"

(3) After finished the settings, click "**Save to Device**" button in Device Configuration to save all the settings.

(4) Get the response data of HART command 3 and 158 via Modscan tool.

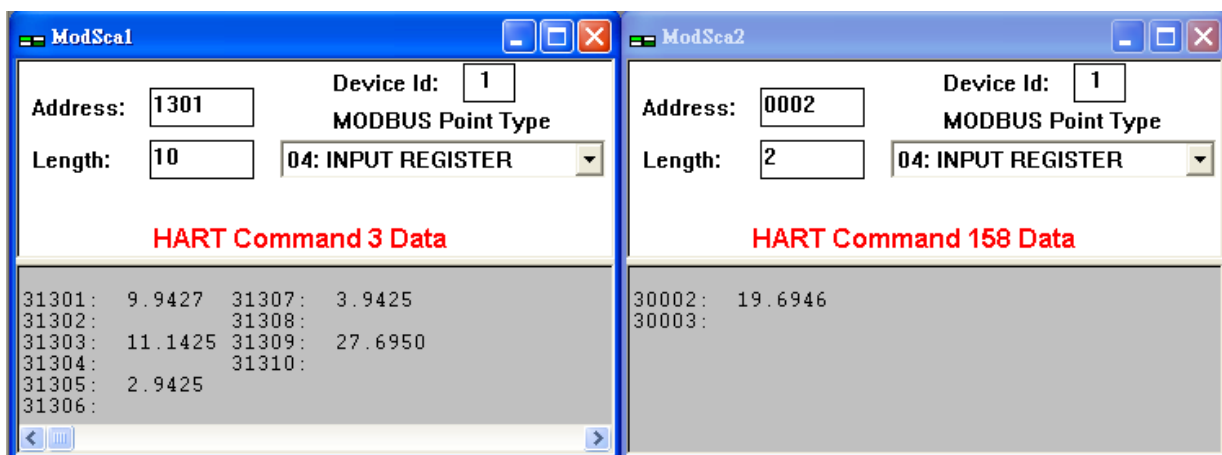

Fig 27-5 HART command 3 and 158 data shown in Modscan



### 3. Example-2: ( There two HART devices in HART network )

(1) Using HDS (HART Device Simulator) software to set HART device address 1 and address 3 and HART command 3 data as the below figure for these two HART devices.

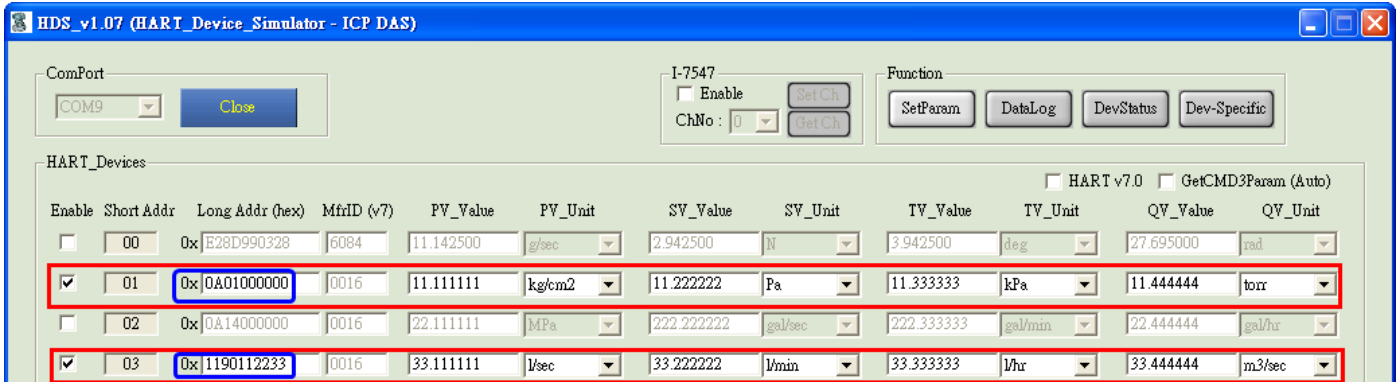

Fig 27-6 Set HART device address and command 3 data in HDS

(2) Add HART device with address 1 and address 3 to HRT-711.

[1] Users need to un-check the “Auto Get Unique ID” checkbox and fill with the long frame address of HART device.

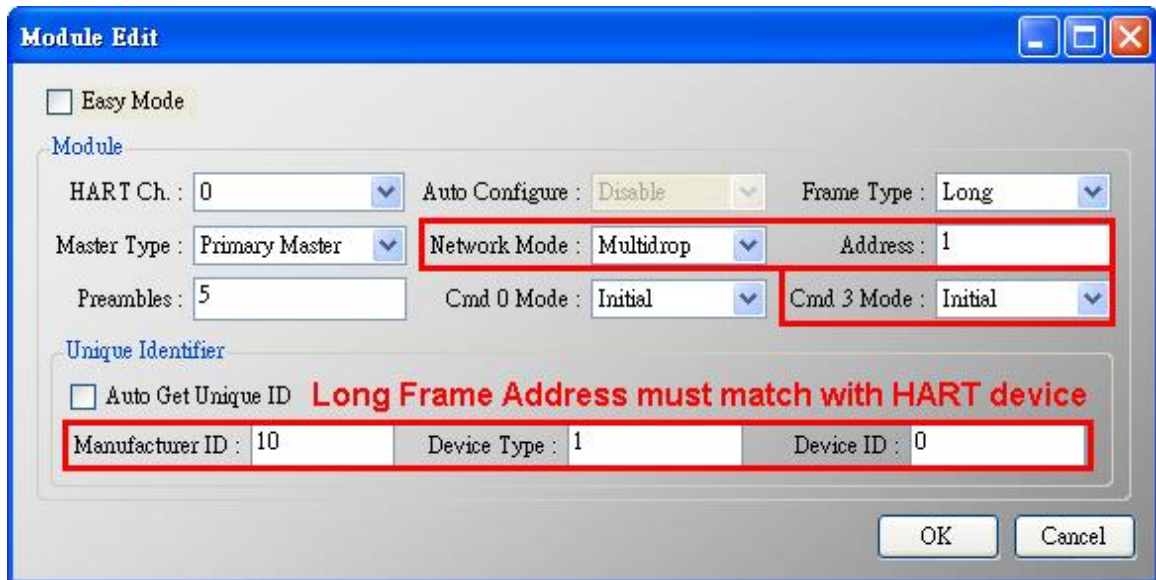

Fig 27-7-1 Add HART device with address 1 (0x0A01000000)

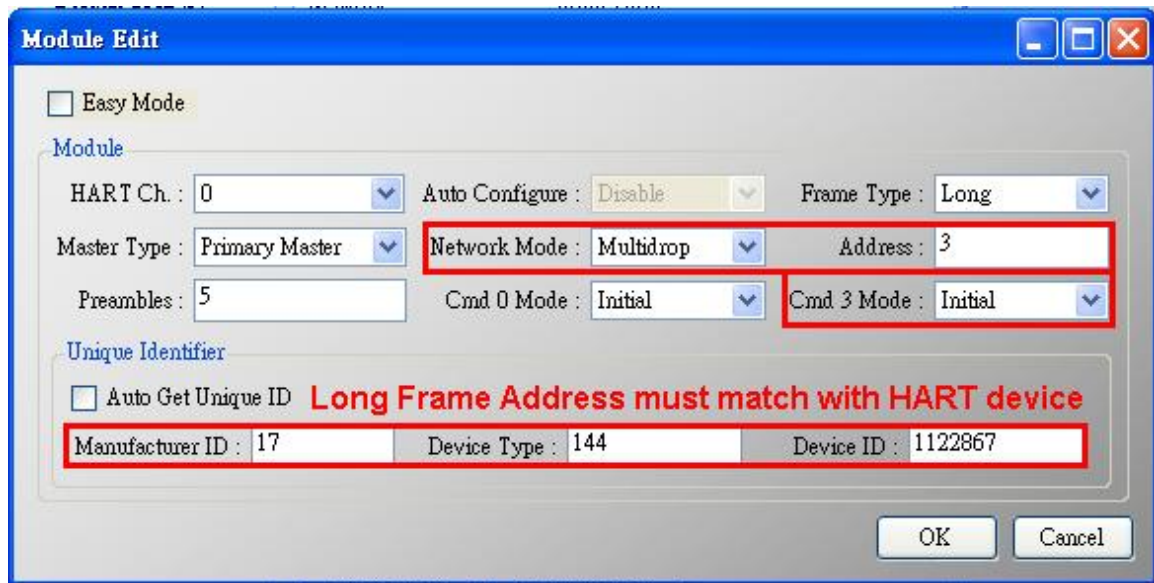

Fig 27-7-1 Add HART device with address 3 (0x1190112233)

(2) In the "System Edit" page, Set "Auto Polling" to be "Disable"(HRT-711 will not send HART command) and set the "Swap Mode" to be "W&B".

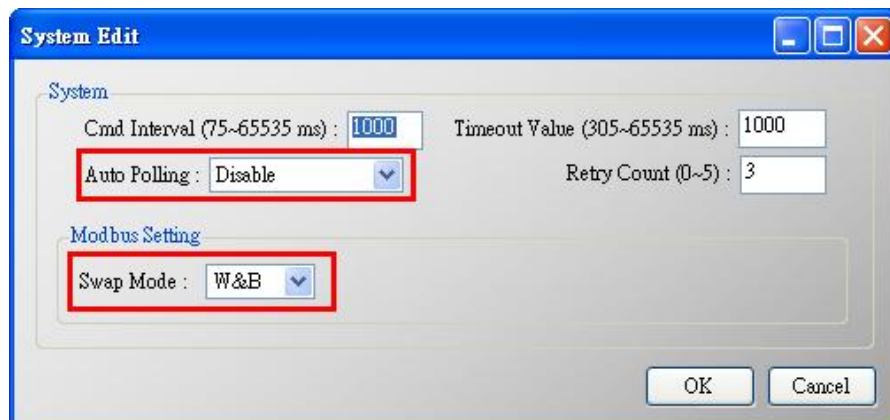

Fig 27-8 Set "Auto Polling" to be "Disable"

- (3) After finished the settings, click "**Save to Device**" button in Device Configuration to save all the settings.
- (4) Get the response data of HART command 3 of these two HART devices via Modscan tool.



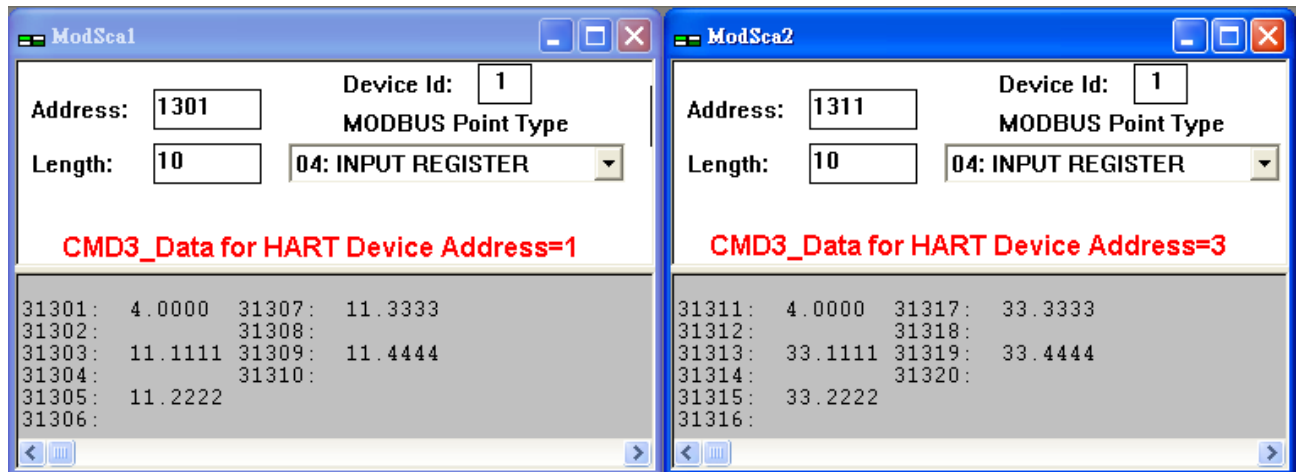

Fig 27-9 HART command 3 data of HART device address 1 and 3 shown in Modscan

## Q101 : The whole configuration process of HRT-711 ?

A101: (2016/02/19)

1. Set the network parameters of HRT-711 (Ex : IP / Mask / Gateway) ◦

- (1) Connect the Ethernet port between PC and HRT-711.
- (2) Run the “HRT-711 Utility” and click the “Ethernet” item.

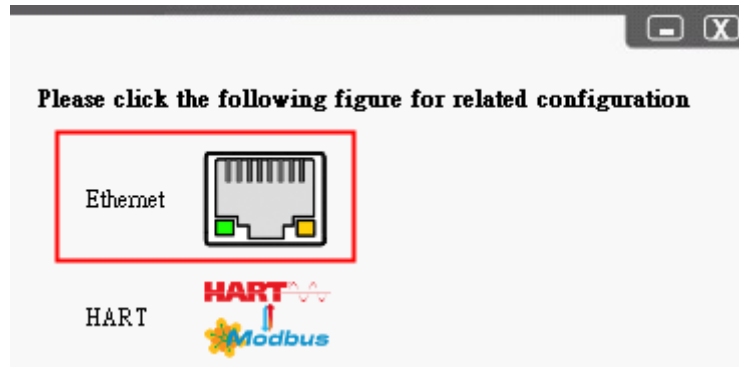

(3) Click the “Search Servers” button and it will search all the HRT-711 modules automatically.

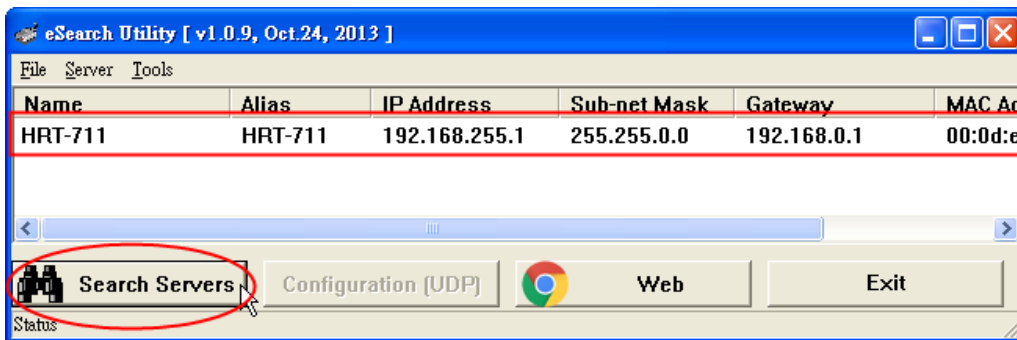

(4) Choose the “HRT-711” item and click the “Configuratio (UDP)” button and users can set the network parameters of HRT-711. Then click the “OK” button to save the settings.

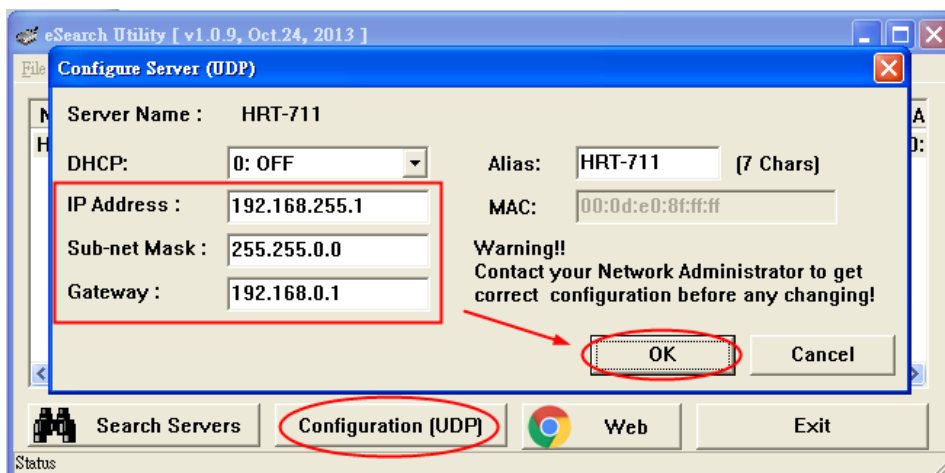

2. Run the HRT-711 utility to connect to HRT-711 via RS-232 for HART configuration.

- (1) Using the CA-0910 cable (3 pin RS-232, TxD/RxD/GND) included in the HRT-711 product. Connect the TXD / RXD / GND pins between CA-0910 and HRT-711. (Wiring : TXD to TXD, RXD to RXD, GND to GND)

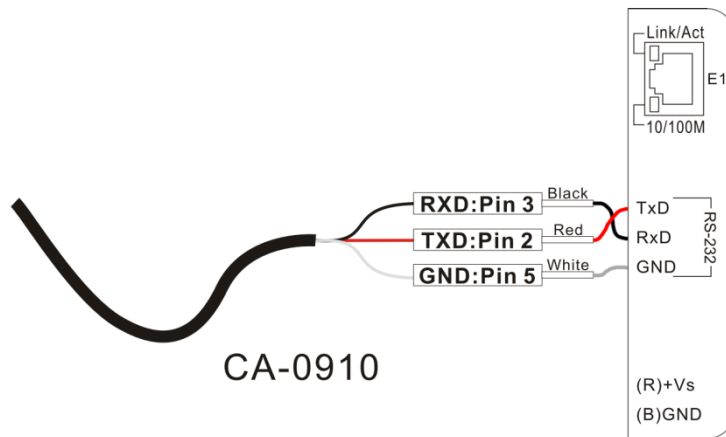

(Note : The RS-232 pin assignment of HRT-711, the left pin1 is reserved and then the left pin2, 3 and 4 will be TXD, RxD and GND.)

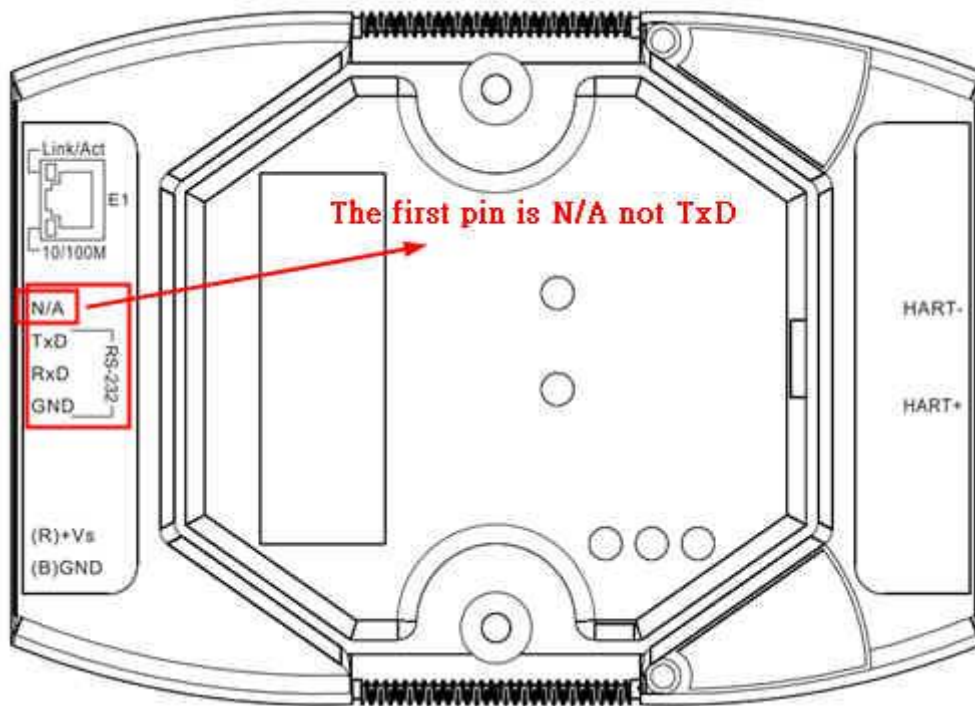

(2)Run the “HRT-711 Utility” and click the “HART” item.

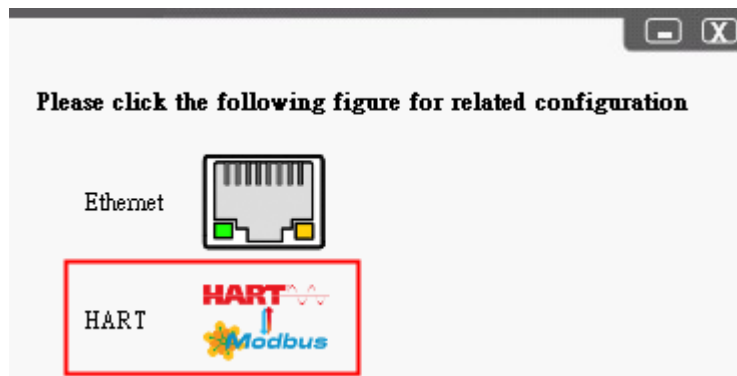

(3) Follow the instruction of the figure to set the “Dip Switch” in the back of HRT-711 to be “Init” and then reboot HRT-711.

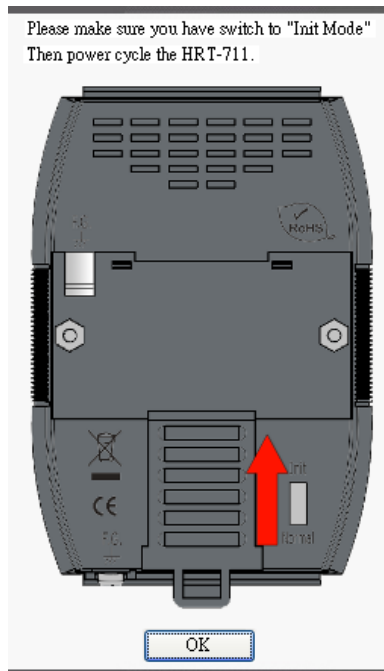

(4) Click the “Communication Settings” item.

[1] Device : choose the “HRT-711”.

[2] Port Num : choose the ComPort no. of PC.

=> After finish, click the “OK” button.

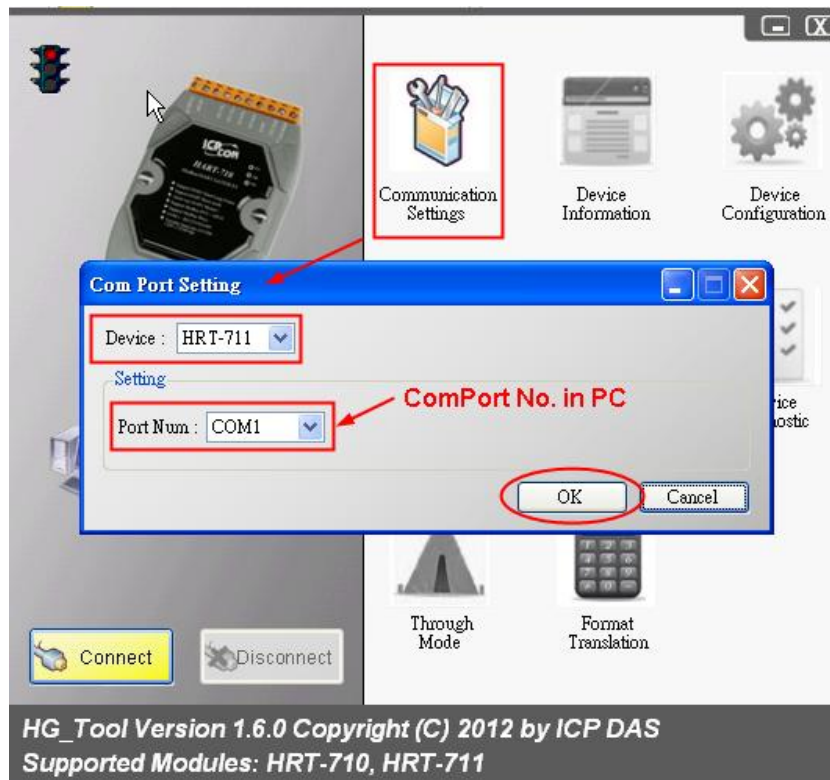

(5) Click the “Connect” button. After about 5 seconds, if the green light is “ON” of the traffic light in the left-top corner of HRT-711 utility, it means the connection is successful. Then users can configure the HRT-711 for HART devices.



1. Add the HART devices to HRT-711.

(1) The detailed steps, please refer to the “Q01 : How to add HART devices to HRT-711 ?” of FAQ.

2. Check if HRT-711 gets the HART device data correctly.

(1) The detailed steps, please refer to the “Q02 : How to make sure that HRT-711 gets the HART device data correctly ?” of FAQ.

=> If the communication between HRT-711 and HART devices is failed, the ERR LED will flash. If the communication is ok, the ERR LED will be OFF.

3. Get the HART device data via Modbus/TCP or Modbus/UDP.

(1) Set the “Dip Switch” in the back of HRT-711 to be “Normal” and then reboot HRT-711.

(2) Refer to the detailed steps of the “Q03 : How to map HART device CMD(3) data directly to SCADA or HMI ?” of FAQ.

# Appendix A HART Command

In this chapter, the following lists are the HART universal command format.

## Command 0 : Read Unique Identifier

Request Data Bytes	0	
Response Data Bytes	2 + 12 = 14	
Byte Index	Format	Description
0	Uint8	Response Code 1
1	Uint8	Response Code 2
2	Uint8	254
3	Uint8	Manufacturer ID
4	Uint8	Manufacturer's device ID
5	Uint8	Number of preambles needed in the request
6	Uint8	Command set revision number
7	Uint8	Transmitter specific revision code
8	Uint8	Software revision
9	Uint8	Hardware revision
10	Uint8	Flags
11~13	Uint24	Device ID number (MSB first)

## Command 1 : Read Primary Variable

Request Data Bytes	0	
Response Data Bytes	2 + 5 = 7	
Byte Index	Format	Description
0	Uint8	Response Code 1
1	Uint8	Response Code 2
2	Uint8	Unit code
3~6	Float	Primary Variable

**Command 2 : Read P.V. Current and Percentage of Range**

Request Data Bytes	0	
Response Data Bytes	2 + 8 = 10	
Byte Index	Format	Description
0	Uint8	Response Code 1
1	Uint8	Response Code 2
2~5	Float	Primary Variable Current
6~9	Float	Primary Variable Percentage of Range

**Command 3 : Read Dynamic Variables and P.V. Current**

Request Data Bytes	0	
Response Data Bytes	2 + 24 = 26	
Byte Index	Format	Description
0	Uint8	Response Code 1
1	Uint8	Response Code 2
2~5	Float	Primary Variable Current
6	Uint8	Primary Variable Unit code
7~10	Float	Primary Variable
11	Uint8	Secondary Variable Unit code
12~15	Float	Secondary Variable
16	Uint8	Tertiary Variable Unit code
17~20	Float	Tertiary Variable
21	Uint8	Quaternary Variable Unit code
22~25	Float	Quaternary Variable

**Command 6 : Write Polling Address**

Request Data Bytes	1	
Byte Index	Format	Description
0	Uint8	Polling Address
Response Data Bytes	2 + 1 = 3	
Byte Index	Format	Description
0	Uint8	Response Code 1
1	Uint8	Response Code 2
2	Uint8	Polling Address

**Command 11 : Read Unique Identifier Associated with TAG**

Request Data Bytes		6
Byte Index	Format	Description
0~5	PA6	TAG Name
Response Data Bytes		2 + 12 = 14
Byte Index	Format	Description
0	UInt8	Response Code 1
1	UInt8	Response Code 2
2	UInt8	254
3	UInt8	Manufacturer ID
4	UInt8	Manufacturer's device ID
5	UInt8	Number of preambles needed in the request
6	UInt8	Command set revision number
7	UInt8	Transmitter specific revision code
8	UInt8	Software revision
9	UInt8	Hardware revision
10	UInt8	Flags
11~13	UInt24	Device ID number (MSB first)

**Command 12 : Read Message**

Request Data Bytes		0
Response Data Bytes		2 + 24 = 26
Byte Index	Format	Description
0	UInt8	Response Code 1
1	UInt8	Response Code 2
2~25	PA24	Message

**Command 13 : Read Tag, Descriptor, Date**

Request Data Bytes		0
Response Data Bytes		2 + 21 = 23
Byte Index	Format	Description
0	UInt8	Response Code 1
1	UInt8	Response Code 2
2~7	PA6	TAG Name



8~19	PA12	Descriptor
20	UInt8	Day of month
21	UInt8	Month of year
22	UInt8	Year as offset to 1900

#### Command 14 : Read Primary Variable Sensor Information

Request Data Bytes	0	
Response Data Bytes	2 + 16 = 18	
Byte Index	Format	Description
0	UInt8	Response Code 1
1	UInt8	Response Code 2
2~4	UInt24	Sensor Serial Number (MSB first)
5	UInt8	Sensor limits unit
6~9	Float	Upper sensor limit
10~13	Float	Lower sensor limit
14~17	Float	Minimum span

#### Command 15 : Read Primary Variable Output Information

Request Data Bytes	0	
Response Data Bytes	2 + 17 = 19	
Byte Index	Format	Description
0	UInt8	Response Code 1
1	UInt8	Response Code 2
2	UInt8	Alarm select code
3	UInt8	Transfer function code
4	UInt8	PV range value unit code
5~8	Float	Upper range value
9~12	Float	Lower range value
13~16	Float	Damping value
17	UInt8	Write protect code
18	UInt8	Private label distribution code

**Command 16 : Read Final Assembly Number**

Request Data Bytes	0	
Response Data Bytes	2 + 3 = 5	
Byte Index	Format	Description
0	UInt8	Response Code 1
1	UInt8	Response Code 2
2~4	UInt24	Final assembly number (MSB first)

**Command 17 : Write Message**

Request Data Bytes	24	
Byte Index	Format	Description
0~23	PA24	Message
Response Data Bytes	2 + 24 = 26	
Byte Index	Format	Description
0	UInt8	Response Code 1
1	UInt8	Response Code 2
2~25	PA24	Message

**Command 18 : Write Tag, Descriptor, Date**

Request Data Bytes	21	
Byte Index	Format	Description
0~5	PA6	TAG Name
6~17	PA12	Descriptor
18	UInt8	Day of month
19	UInt8	Month of year
20	UInt8	Year as offset to 1900
Response Data Bytes	2 + 21 = 23	
Byte Index	Format	Description
0	UInt8	Response Code 1
1	UInt8	Response Code 2
2~7	PA6	TAG Name
8~19	PA12	Descriptor
20	UInt8	Day of month

21	Uint8	Month of year
22	Uint8	Year as offset to 1900

**Command 19 : Write Final Assembly Number**

Request Data Bytes		3
Byte Index	Format	Description
0~2	Uint24	Final assembly number (MSB first)
Response Data Bytes		2 + 3 = 5
Byte Index	Format	Description
0	Uint8	Response Code 1
1	Uint8	Response Code 2
2~4	Uint24	Final assembly number (MSB first)

# Appendix B Command Format

The HART data format of Modbus address is divided into the Normal and Simple format.

## 1. Normal format

When read / write HART data by Modbus, the Modbus data format is HART standard command format.

## 2. Simple format

When read / write HART data by Modbus, the Modbus data format is simple format (omit the Response Code and Unit data). In this mode, the HMI or SCADA software can read or write HART data easily. Now, it only supports HART command number 1, 2 and 3.

### The simple format of HART command

#### Command 1 : (Read Primary Variable)

Response Data Bytes	4	
Byte Index	Format	Description
0~3	Float	Primary Variable

#### Command 2 : (Read P.V. Current and Percentage of Range)

Response Data Bytes	8	
Byte Index	Format	Description
0~3	Float	Primary Variable Current
4~7	Float	Primary Variable Percentage of Range

#### Command 3 : (Read Dynamic Variables and P.V. Current)

Response Data Bytes	20	
Byte Index	Format	Description
0~3	Float	Primary Variable Current
4~7	Float	Primary Variable
8~11	Float	Secondary Variable
12~15	Float	Tertiary Variable
16~19	Float	Quaternary Variable

## Appendix C. Revision History

This chapter provides revision history information to this document.

The table below shows the revision history.

Revision	Date	Description
1.10	2020/08/19	Add Fig 2.3.2-4 Add FAQ Q26 Add the "In Offset" field in the UserCMD setting
1.09	2020/07/02	Add FAQ Q24 / Q25
1.08	2018/10/29	Add FAQ Q21 Add FAQ Q22 Add FAQ Q23
1.07	2018/05/22	Modify FAQ Q15, 18, 19 with Modbus command FC06 FAQ Q04 add TCP firmware update section
1.06	2018/04/10	Add FAQ Q20
1.05	2017/12/20	Add FAQ Q18, Q19
1.04	2017/05/10	Add MB starting address explanation to FAQ Q03
1.03	2016/10/20	Add FAQ17 Modify Firmware Update Process (Q04 of FAQ)
1.02	2016/01/28	Modbus/UDP server is also supported.
1.01	2015/08/04	Add FAQ chapter to this users' manual
1.00	2014/01/21	First revision