

## Industrial 4-Port 10/100TX + 2-Port 1000X SFP Ring Ethernet Switch



### Slim Type for More Practicability and Convenience

PLANET IFGS-620TF is the first Unmanaged industrial-grade Ring Ethernet Switch, featuring **four 10/100BASE-TX copper ports** and **two 1000BASE-X SFP fiber ports** and packed in an IP30-rated rugged but compact-size case. Being able to operate under the temperature ranging from **-40 to 75 degrees C** and a wide-ranging redundant power system (**9~48V DC** or **24V AC**), the IFGS-620TF provides a reliable, stable and continuous long-range data transmission and can be installed in any harsh environment without taking space into consideration.

In response to the growing demand for IIoT (Industrial Internet of Things) infrastructure, the IFGS-620TF is designed for easy deployment of industrial networks with its Plug and Play capability. Furthermore, it ensures stable and reliable fast data and power transmission. The IFGS-620TF also supports PROFINET traffic pass-through with QoS, making it an ideal choice for integrating with industrial automation systems and enhancing communication between devices in a factory setting.



### Fast Recovery for Industrial Ethernet Transmission Applications

The IFGS-620TF supports the super-fast, fault-tolerant ring redundancy technology and features strong rapid self-recovery capability to prevent interruptions and external intrusions. Its **dual SFP ports** incorporate advanced **ring data recovery through DIP switch** technology and **redundant power** input system into customer's industrial automation network to enhance system reliability and uptime in harsh environments. In a simple Ring network with **8 units**, the recovery time of data link can be **as fast as 1ms**.

### Physical Port

- Four 10/100BASE-TX RJ45 ports with auto MDI/MDI-X function
- Two SFP interfaces, supporting 1000BASE-X transceiver type auto detection

### One Key Ring Feature

- In a simple Ring network with 8 units, the recovery time of data link can be as fast as 1ms.

### Layer 2 Features

- Complies with IEEE 802.3 10BASE-T, IEEE 802.3u 100BASE-TX, IEEE 802.3z 1000BASE-X Ethernet standard
- Supports auto-negotiation and 10/100Mbps half/full duplex mode
- Prevents packet loss with back pressure (half-duplex) and IEEE 802.3x pause frame flow control (full-duplex)
- High-performance Store and Forward architecture, broadcast storm control and runt/CRC filtering eliminate erroneous packets to optimize the network bandwidth
- Backplane (switching fabric): 4.8Gbps
- Integrated address look-up engine, supporting 4K absolute MAC addresses
- 16K jumbo packet size
- Automatic address learning and address aging
- IEEE 802.1p Class of Service (Works under Ring function disable)
- IEEE 802.1Q VLAN transparency
- CSMA/CD Protocol

### Industrial Case and Installation

- Slim IP30 metal case
- DIN-rail, wall-mount or side wall-mount design for redundant power design
  - 9 to 48V DC, redundant power with reverse polarity protection
  - AC 24V power adapter acceptable
- Supports 6000 VDC Ethernet ESD protection
- -40 to 75 degrees C operating temperature
- Free fall, shock-proof and vibration-proof for industries

Due to differences in design between the IFGS-620TF One Key Ring and the ERPS Ring functions available on PLANET Industrial Managed Switch devices, the two functions are not compatible with each other. The IFGS-620TF One Key Ring function offers easier and faster deployment with DIP switch adjustments.

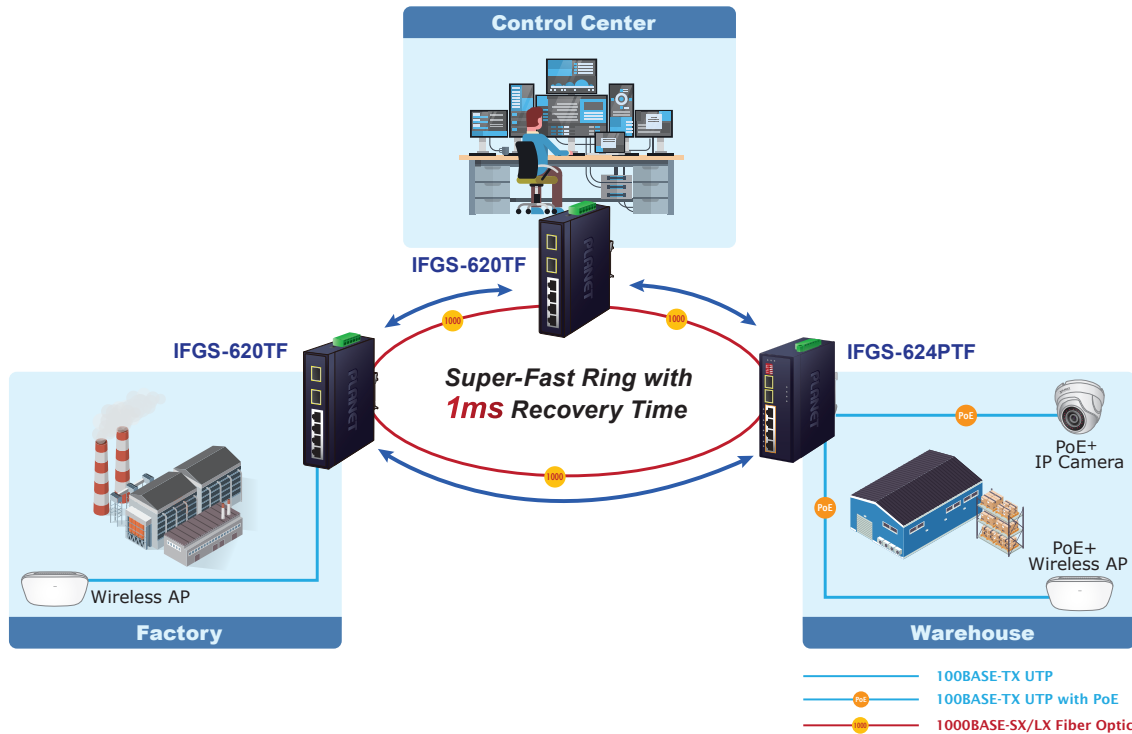

### PROFINET Traffic with Higher Delivery Priority

The IFGS-620TF features a brand-new function that enhances support for recognizing the PROFINET traffic for higher delivery priority. Once the IFGS-620TF receives the PROFINET traffic, it will forward the PROFINET traffic first, and then handle other Ethernet traffic. With this enhanced function, the IFGS-620TF will become the ideal Industrial Unmanaged Switch for the faster PROFINET traffic.

## PLANET PROFINET Protocol Pass-through Industrial Switch

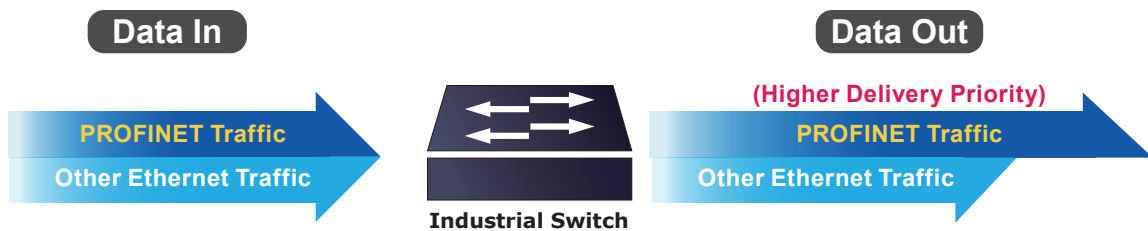

### Fiber Optic Link Capability Enables Extension of Network Deployment

The IFGS-620TF's two SFP ports are compatible with **1000BASE-X** SFP (small form factor pluggable) fiber-optic transceivers. The fiber optic uplink capability guarantees the throughput to all nodes hooked into the network and the Gigabit Ethernet distance can be extended from 550 meters (Multi-mode fiber cable) to 120 kilometers (Single-mode fiber cable). They are well suited for applications within the factory data centers and distributions.

Thus, building a network solution of FTTH (Fiber to the Home), FTTC (Fiber to the Curb) for ISPs or FTTB (Fiber to the Building) for enterprises becomes so easy to users when long-distance deployment is employed. The IFGS-620TF can handle extremely large amounts of data in a secure topology linking to a metro switch, backbone or high-capacity server.

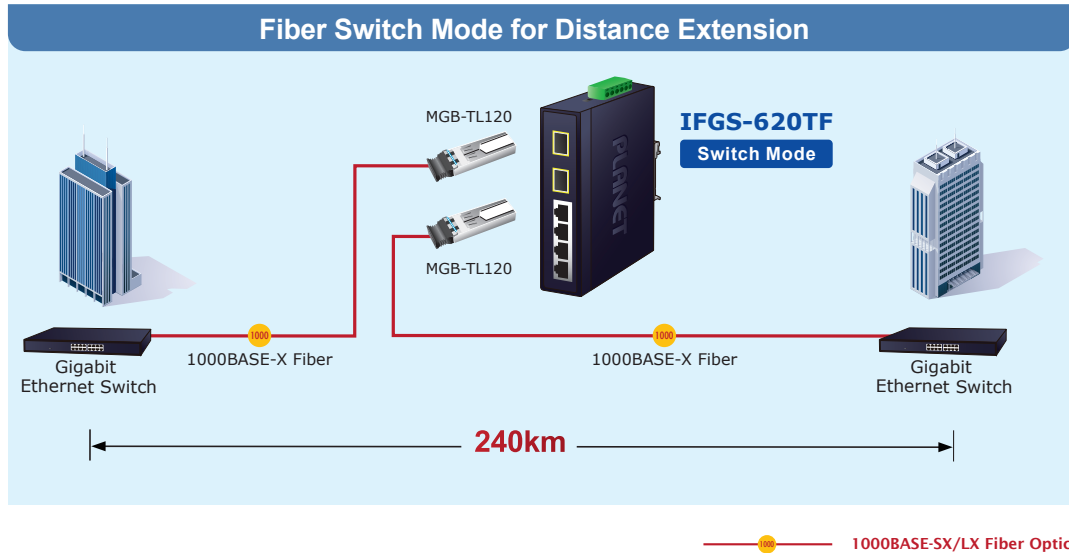

**Dual Power Input for High Availability Network System**

The IFGS-620TF features a strong dual power input system with wide-ranging voltages (9V~48V DC or 24V AC) incorporated into customer's automation network to enhance system reliability and uptime. In the example below, when power supply 1 fails to work, the hardware failover function will be activated automatically to keep powering the IFGS-620TF via power supply 2 alternatively without any loss of operation.

**Non-stop Ethernet Transmission  
Dual Power Input with Auto Failover**

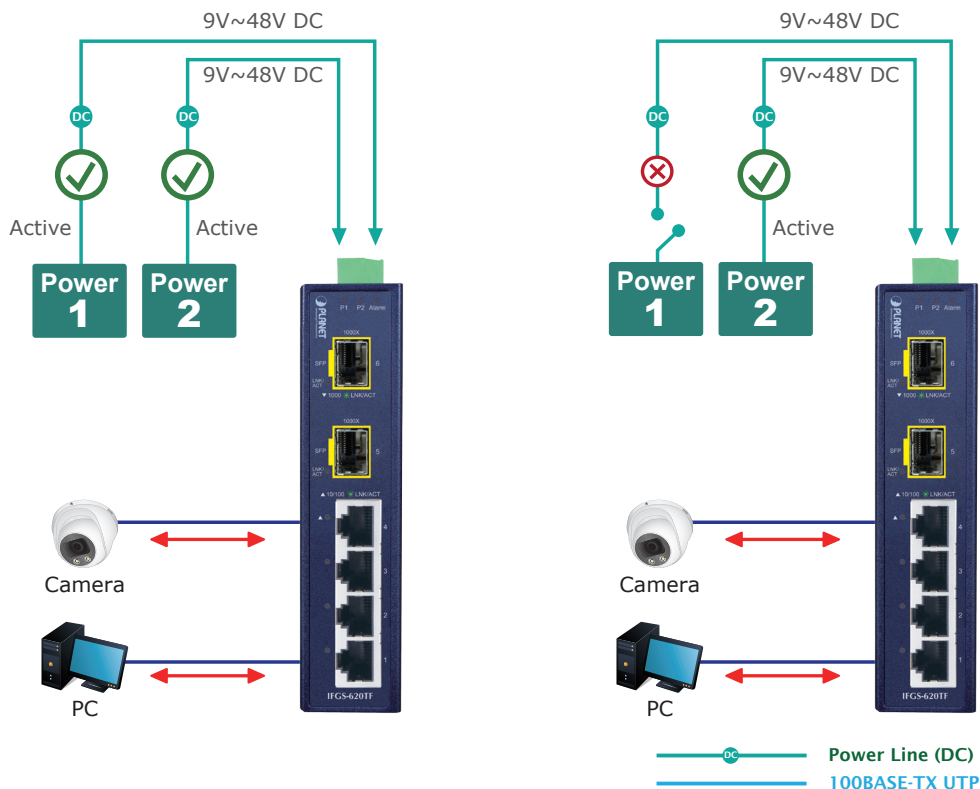

### Low Power Consumption for Green Networking to Implement ESG

The IFGS-620TF, adopting the advanced green networking technology, provides cable length power saving, and link-up and link-down power saving. These features make the IFGS-620TF consume very low power in full load operation mode, which helps conserve energy effectively but maintains high performance efficiently.

With the **IEEE 802.3az Energy Efficient Ethernet (EEE)** Protocol, the IFGS-620TF can automatically detect cable link status and network traffic, and thus is able to adjust power consumption accordingly. It enables the switch to consume less power when it is less active.

### Robust Protection

The IFGS-620TF provides a contact discharge of  $\pm 6\text{KV}$  DC and air discharge of  $\pm 6\text{KV}$  DC for Ethernet ESD protection. It also supports  $\pm 6\text{KV}$  surge immunity to improve product stability and protects users' networks from devastating ESD attacks, making sure the flow of operation does not fluctuate.

### Flexible and Easy Installation with Limited Space

The compact-sized IFGS-620TF is specially designed to be installed in a narrow environment, such as wall enclosure. It can be installed by fixed wall mounting or DIN rail, thereby making its usability more flexible and easier in any space-limited location.

## Optional installation method



\* The above pictures are for illustration only.

## Applications

### One Key Ring Makes Data Transmission Uninterrupted

The IFGS-620TF features strong rapid self-recovery capability to prevent interruptions and external intrusions. It incorporates **super-fast, fault-tolerant ring redundancy technology** into customer's automation network to enhance system reliability and uptime. The IFGS-620TF can easily help system integrators with the available network infrastructure to build wireless AP, IP camera and VoIP systems where power can be centrally-controlled. In a simple Ring network with **8 units**, the recovery time of data link can be **as fast as 1ms**.

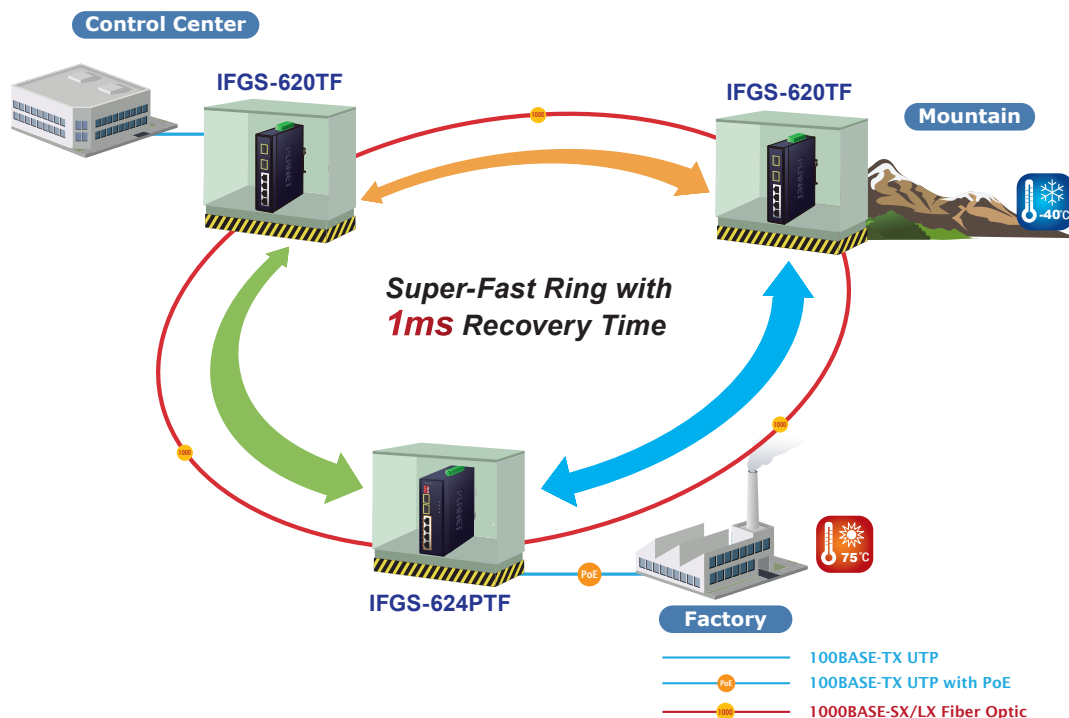

**Ethernet Applications with Long-distance Fiber Uplink for Hardened Environment**

The IFGS-620TF Unmanaged industrial-grade Ring Ethernet Switch offers four 10/100BASE-TX ports. It provides very high reliability and security features to make sure the continuous operation in harsh environments such as control cabinet of transportation, factory, outdoors and places where extreme low or high temperatures can be experienced. Moreover, the IFGS-620TF is also compatible with 1000Mbps SFP transceivers to provide a strong, stable and long-distance connection and flexible industrial networking deployment.

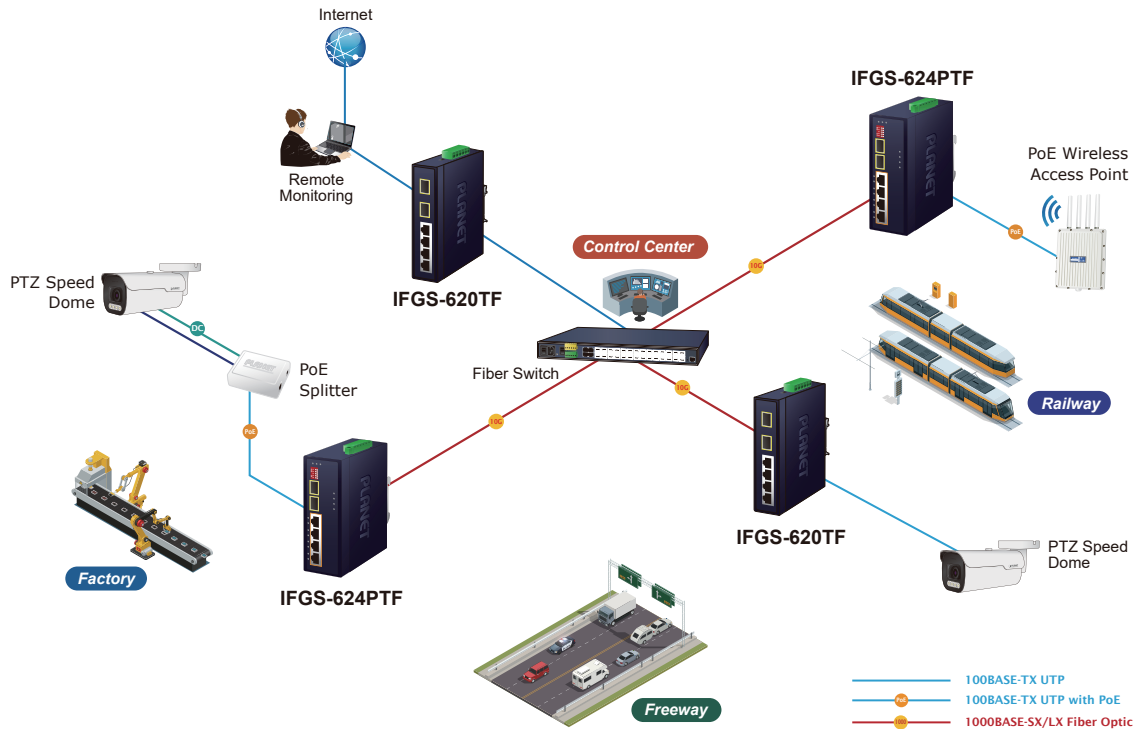

**Fiber-optic Networking for ISPs, Enterprises, and Homes**

With stable performance of data transmission and easy installation, the IFGS-620TF Industrial Gigabit fiber switch can build an ISP network solution of FTTH (Fiber to the Home), FTTC (Fiber to the Curb) for ISPs, or FTTB (Fiber to the Building) for enterprises with small office network environment.

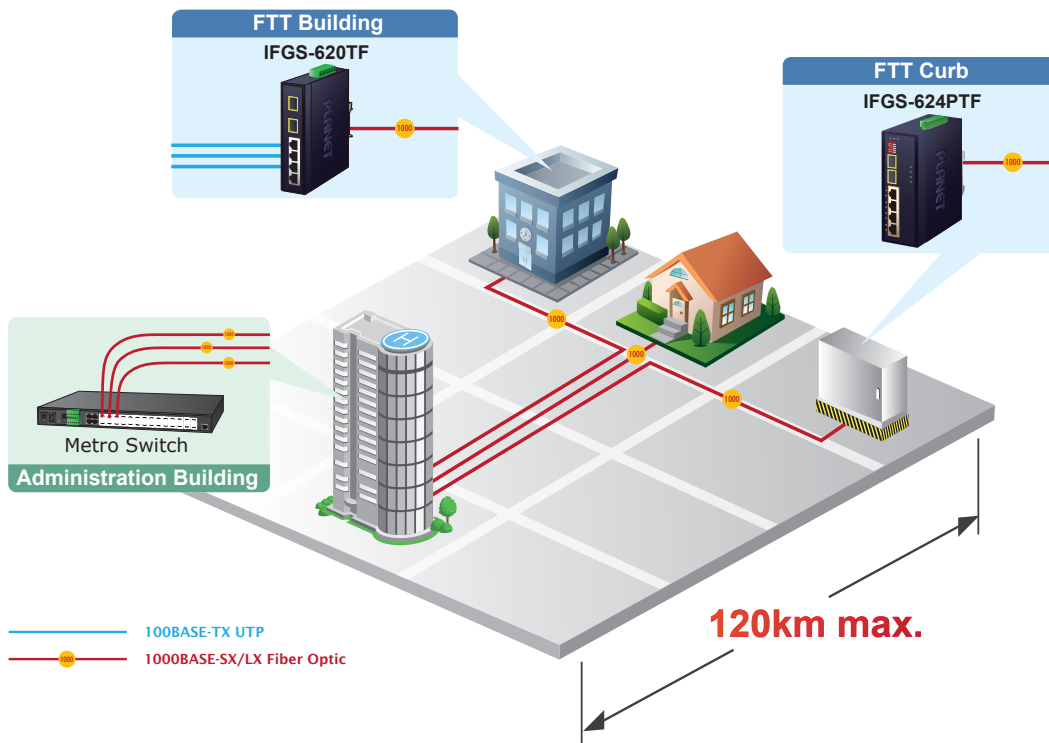

## Specifications

Model	IFGS-620TF		
<b>Hardware Specifications</b>			
Copper Ports	4 x 10/100BASE-TX RJ45 TP Auto-MDI/MDI-X, auto-negotiation		
SFP Slots	2 x 1000BASE-X SFP interfaces		
DIP Switch	DIP Switch	Position	Function
	Mode	OFF	Ring
		ON (default)	Switch Mode
	<b>Note :</b> 1. Power off the IFGS-620TF before adjusting the DIP switch and then power it on. 2. The Ring function can reach simple Ring network with 8 units, the recovery time of data link can be as fast as 1ms. 3. Ring performance may vary depending on the length of the fiber optic and UTP cables.		
Connector	Removable 6-pin terminal block Pin 1/2 for Power 1; Pin 3/4 for fault alarm; Pin 5/6 for Power 2		
Alarm	Provides one relay output for power failure Alarm Relay current carry ability: 1A @ DC 24V		
ESD Protection	±6KV air gap discharge ±6KV contact discharge		
Surge Immunity	6KV DC		
Enclosure	IP30 type metal case		
Installation	DIN-rail kit and wall-mount ear		
Dimensions (W x D x H)	32 x 87.8 x 135mm		
Weight	430g		
Power Requirements	DC 9~48V or AC 24V Redundant power with reverse polarity protection		
Power Consumption / Dissipation	3.4watts/11.6BTU		
LED	3 x LED for System and Power: ■ <b>Green:</b> DC Power 1 ■ <b>Green:</b> DC Power 2 ■ <b>Red:</b> Alarm 2 x LED for Per Copper Port (Port-1~Port-4): ■ <b>Green:</b> 10/100 LNK/ACT 1 x LED for Per SFP interface (Port-5~Port-6) ■ <b>Greenn:</b> 1G LNK/ACT		
<b>Switch Specifications</b>			
Switch Processing Scheme	Store-and-Forward		
Switch Fabric	4.8Gbps		
Throughput (packet per second)	3.57Mpps@64bytes		
Address Table	4K entries		
Jumbo Frame	16K bytes		
Flow Control	Back pressure for half duplex IEEE 802.3x pause frame for full duplex		
<b>Standards Conformance</b>			
Standards Compliance	IEEE 802.3 Ethernet IEEE 802.3u Fast Ethernet IEEE 802.3ab Gigabit Ethernet IEEE 802.3z Gigabit Ethernet 1000BASE-SX/LX IEEE 802.3x Full-Duplex Flow Control IEEE 802.1p Class of Service (Works under Ring function disable) PROFINET Traffic Pass-through with QoS		
Regulatory Compliance	FCC Part 15 Class A, CE		
Stability Testing	IEC60068-2-32 (Free fall) IEC60068-2-27(Shock) IEC60068-2-6 (Vibration)		
<b>Environment</b>			
Temperature	Operating: -40~75 degrees C Storage: -40~75 degrees C		
Humidity	Operating: 5~95% (Non-condensing) Storage: 5~95% (Non-condensing)		

## Dimensions

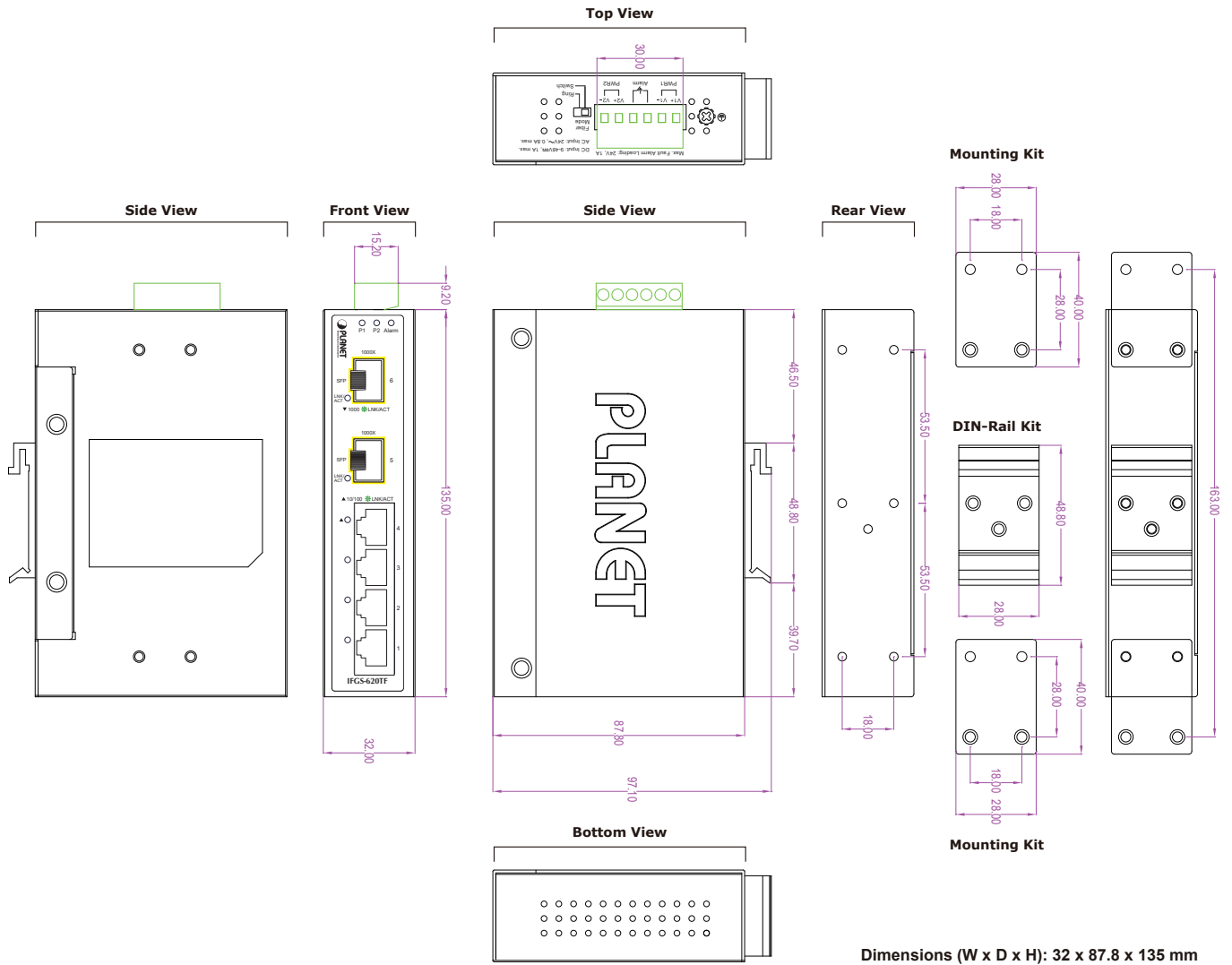

## Ordering Information

IFGS-620TF

Industrial 4-Port 10/100TX + 2-Port 1000X SFP Ring Ethernet Switch

## Related Product

IFGS-624PTF

Industrial 4-Port 10/100TX 802.3at PoE + 2-Port 1000X SFP Ring Ethernet Switch

## Related Gigabit SFP Transceivers

MGB-GT	SFP-Port 1000 BASE-T Module
MGB-LX	SFP-Port 1000 BASE-LX mini-GBIC module - 20km
MGB-SX	SFP-Port 1000 BASE-SX mini-GBIC module - 550m
MGB-SX2	SFP-Port 1000 BASE-SX mini-GBIC module - 2km
MGB-L40	SFP-Port 1000 BASE-LX mini-GBIC module - 40km
MGB-L80	SFP-Port 1000 BASE-LX mini-GBIC module - 80km
MGB-L120	SFP-Port 1000 BASE-LX mini-GBIC module - 120km
MGB-LA10	SFP-Port 1000 BASE-BX (WDM, TX:1310nm) mini-GBIC module - 10km
MGB-LB10	SFP-Port 1000 BASE-BX (WDM, TX:1550nm) mini-GBIC module - 10km
MGB-LA20	SFP-Port 1000 BASE-BX (WDM, TX:1310nm) mini-GBIC module - 20km
MGB-LB20	SFP-Port 1000 BASE-BX (WDM, TX:1550nm) mini-GBIC module - 20km
MGB-LA40	SFP-Port 1000 BASE-BX (WDM, TX:1310nm) mini-GBIC module - 40km
MGB-LB40	SFP-Port 1000 BASE-BX (WDM, TX:1550nm) mini-GBIC module - 40km
MGB-LA80	SFP-Port 1000 BASE-BX (WDM, TX:1490nm) mini-GBIC module - 80km
MGB-LB80	SFP-Port 1000 BASE-BX (WDM, TX:1550nm) mini-GBIC module - 80km
MGB-TSX	SFP-Port 1000 BASE-SX mini-GBIC module - 550m (-40 ~ 85 degrees C)
MGB-TSX2	SFP-Port 1000 BASE-SX mini-GBIC module - 2km (-40 ~ 85 degrees C)
MGB-TL40	SFP-Port 1000 BASE-LX mini-GBIC module - 40km (-40 ~ 85 degrees C)
MGB-TL80	SFP-Port 1000 BASE-LX mini-GBIC module - 80km (-40 ~ 85 degrees C)
MGB-TLA10	SFP-Port 1000 BASE-BX (WDM, TX:1310nm) mini-GBIC module - 10km (-40 ~ 85 degrees C)
MGB-TLB10	SFP-Port 1000 BASE-BX (WDM, TX:1550nm) mini-GBIC module - 10km (-40 ~ 85 degrees C)
MGB-TLA20	SFP-Port 1000 BASE-BX (WDM, TX:1310nm) mini-GBIC module - 20km (-40 ~ 85 degrees C)
MGB-TLB20	SFP-Port 1000 BASE-BX (WDM, TX:1550nm) mini-GBIC module - 20km(-40 ~ 85 degrees C)
MGB-TLA40	SFP-Port 1000 BASE-BX (WDM, TX:1310nm) mini-GBIC module - 40km (-40 ~ 85 degrees C)
MGB-TLB40	SFP-Port 1000 BASE-BX (WDM, TX:1550nm) mini-GBIC module - 40km (-40 ~ 85 degrees C)
MGB-TLA80	SFP-Port 1000 BASE-BX (WDM, TX:1490nm) mini-GBIC module - 80km (-40 ~ 85 degrees C)
MGB-TLB80	SFP-Port 1000 BASE-BX (WDM, TX:1550nm) mini-GBIC module - 80km (-40 ~ 85 degrees C)