

**QBiX-Pro-TGLA1135G7H-A2
(QP-1135A-SI)
QBiX-Pro-TGLA1115G4EH-A2
(QP-1115A-SI)**

QBiX-Pro Industrial Embedded System
Quick Start Guide

Copyright Notice

This document is copyrighted, 2022. All rights are reserved. The original manufacturer reserves the right to make improvements to the products described in this manual at any time without notice.

No part of this manual may be reproduced, copied, translated, or transmitted in any form or by any means without the prior written permission of the original manufacturer. Information provided in this manual is intended to be accurate and reliable. However, the original manufacturer assumes no responsibility for its use, or for any infringements upon the rights of third parties that may result from its use.

The material in this document is for product information only and is subject to change without notice. While reasonable efforts have been made in the preparation of this document to assure its accuracy, GIGAIPC assumes no liabilities resulting from errors or omissions in this document, or from the use of the information contained herein.

GIGAIPC reserves the right to make changes in the product design without notice to its users.

Acknowledgement

All other products' name or trademarks are properties of their respective owners.

- AMD is trademark of Advanced Micro Devices.
- Microsoft Windows is a registered trademark of Microsoft Corp.
- Intel, Pentium, Celeron, and Xeon are registered trademarks of Intel Corporation
- Core, Atom are trademarks of Intel Corporation
- ITE is a trademark of Integrated Technology Express, Inc.
- IBM, PC/AT, PS/2, and VGA are trademarks of International Business Machines Corporation.

All other product names or trademarks are properties of their respective owners.

Packing List

Before setting up your product, please make sure the following items have been shipped:

Item	Quantity
System kit	1
HDD screw, M3 x 8L (25KSG-130081-K1R)	4
SATA Cable (25CRI-070000-S9R)	1
Exsiccator (10g)	1
Thermal pad for Memory (25ST3-200086-T5R)	1
Power Cord : Optional (by region)	1
PSU ADP 19.5V 135W 100-240VAC (25EP4-201352-C1S)	1

If any of these items are missing or damaged, please contact your distributor or sales representative immediately.

About this Document

This User's Manual contains all the essential information, such as detailed descriptions and explanations on the product's hardware and software features (if any), its specifications, dimensions, jumper/connector settings/definitions, and driver installation instructions (if any), to facilitate users in setting up their product.

Users may refer to the GIGAIPC.com for the latest version of this document.

Safety Precautions

Please read the following safety instructions carefully. It is advised that you keep this manual for future references

1. All cautions and warnings on the device should be noted.
2. Make sure the power source matches the power rating of the device.
3. Position the power cord so that people cannot step on it. Do not place anything over the power cord.
4. Always completely disconnect the power before working on the system's hardware.
5. No connections should be made when the system is powered as a sudden rush of power may damage sensitive electronic components.
6. If the device is not to be used for a long time, disconnect it from the power supply to avoid damage by transient over-voltage.
7. Always disconnect this device from any AC supply before cleaning.
8. While cleaning, use a damp cloth instead of liquid or spray detergents.
9. Make sure the device is installed near a power outlet and is easily accessible.
10. Keep this device away from humidity.
11. Place the device on a solid surface during installation to prevent falls
12. Do not cover the openings on the device to ensure optimal heat dissipation.

13. Watch out for high temperatures when the system is running.
14. Do not touch the heat sink or heat spreader when the system is running
15. Never pour any liquid into the openings. This could cause fire or electric shock.
16. As most electronic components are sensitive to static electrical charge, be sure to ground yourself to prevent static charge when installing the internal components. Use a grounding wrist strap and contain all electronic components in any static-shielded containers.
17. If any of the following situations arises, please the contact our service personnel:
 - i. Damaged power cord or plug
 - ii. Liquid intrusion to the device
 - iii. Exposure to moisture
 - iv. Device is not working as expected or in a manner as described in this manual
 - v. The device is dropped or damaged
 - vi. Any obvious signs of damage displayed on the device
- 18. DO NOT LEAVE THIS DEVICE IN AN UNCONTROLLED ENVIRONMENT WITH TEMPERATURES BEYOND THE DEVICE'S PERMITTED STORAGE TEMPERATURES (SEE CHAPTER 1) TO PREVENT DAMAGE.**

FCC Statement

Warning!



This device complies with Part 15 FCC Rules. Operation is subject to the following two conditions: (1) this device may not cause harmful interference, and (2) this device must accept any interference received including interference that may cause undesired operation.

Caution:

There is a danger of explosion if the battery is incorrectly replaced. Replace only with the same or equivalent type recommended by the manufacturer. Dispose of used batteries according to the manufacturer's instructions and your local government's recycling or disposal directives.

Attention:

Il y a un risque d'explosion si la batterie est remplacée de façon incorrecte. Ne la remplacer qu'avec le même modèle ou équivalent recommandé par le constructeur. Recycler les batteries usées en accord avec les instructions du fabricant et les directives gouvernementales de recyclage.

High Temperature Warning

(1) This equipment is intended to be used in Restrict Access Location. The access can only be gained by Skilled person or by Instructed person who have been instructed about the metal chassis of the equipment is so hot that Skilled person have to pay special attention or take special protection. Only authorized by well trained professional person can access the restrict access location.

(2) External metal parts are hot!! Before touching it, special attention or protection is necessary

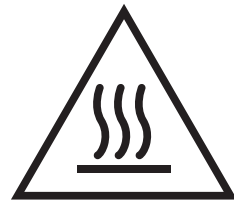

Table Contents

QBiX-Pro Industrial Embedded System Quick Start Guide	1
Copyright Notice	2
Acknowledgement	3
Packing List.....	4
About this Document.....	5
Safety Precautions	6
FCC Statement.....	8
High Temperature Warning	8
 Chapter 1 - Product Specifications	 13
1.1 Specifications	15
 Chapter 2 – QBiX-Pro-TGLA1135G7H-A2 (QP-1135A-SI) QBiX-Pro-TGLA1115G4EH-A2 (QP-1115A-SI) Industrial Embedded System Kit	 17
2.1 Dimension	18
2.2 Getting Familiar with Your Unit.....	19
2.3 A) Wireless Module: How to safely install the Module (Wireless Module inclusion may vary based on local distribution)	21
2.4 B) Memory Installation: DDR4 SO-DIMM	22
2.5 Antenna Installation (Antenna inclusion may vary based on local distribution)	23

2.6	Cable Pin-define	24
2.7	Support	25
2.8	Safety and Regulatory Information.....	26

Chapter 3 – Hardware Information 27

3.1	Jumpers and Connectors	28
3.2.1	SYS_FAN (System fan connector)	31
3.2.2	CPU_FAN (CPU fan connector)	32
3.2.3	FUSB1, FUSB2 (USB2.0 headers)	33
3.2.4	AT_CN (AT/ATX power mode select jumper)	34
3.2.5	JCOM1 (COM1 RI# pin RI#/5V/12V Select).....	35
3.2.6	SATA0 (SATA 6Gb/s connector)	36
3.2.7	SATAPW0 (SATA power connector).....	37
3.2.8	COM2, COM3, COM4 (Serial port header, RS-232/422/485)	38
3.2.9	M2E (M.2 Slot, E-key, NGFF2230, WiFi & Bluetooth module).....	39
3.2.10	MPCIE (Mini PCIe full size, support 3G/4G module)	39
3.2.11	BATTERY (Battery cable Connector)	40
3.2.12	DC_IN (DC IN 1x4 pin power connector)	41
3.2.13	SYS_PANEL (Front panel header)	42
3.2.14	GPIO_CNT (General Purpose input/output header)	43
3.2.15	FP_AUDIO (Front Audio connector)	44
3.2.16	PCIEX1 (PCIe Gen3 x1 connector).....	45

- 3.2.17 ME (ME Enable jumper) 46
- 3.2.18 SPK_OUT (Speaker out connector) 47
- 3.2.19 BKL_CN (Back light brightness control header) 48
- 3.2.20 LVDS (LVDS connector)..... 49
- 3.2.21 LSW (LVDS resolution jumper) 50
- 3.2.22 M2M (M.2 Slot, SATA/PCIeX2, NGFF 2280) 51
- 3.2.23 SODIMM1, SODIMM2 (DDR4 SO-DIMM Slot)..... 51
- 3.2.24 TPM (Trusted Platform Module Connector)..... 52

Chapter 4 – BIOS 53

- 4.1 Introduction 54
- 4.2 The Main Menu..... 55
- 4.3 Advanced 56
 - 4.3.1 TPM Configuration..... 57
 - 4.3.2 SATA And RST Configuration..... 59
 - 4.3.3 CPU Configuration 60
 - 4.3.4 IT8786 Super IO Configuration 61
 - 4.3.5 Hardware Monitor 62
 - 4.3.6 S5 RTC Wake Settings 63
 - 4.3.7 Network Stack Configuration..... 64
 - 4.3.8 NVMe Configuration..... 65
 - 4.3.9 Offboard SATA Controller Configuration 66
 - 4.3.10 Digital IO Port Configuration 67

4.4	Chipset	68
4.5	Security	69
4.6	Boot.....	72
4.7	Save & Exit	73

Chapter 1

Chapter 1 - Product Specifications

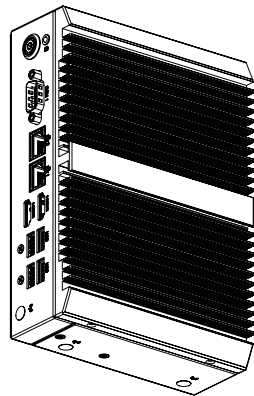
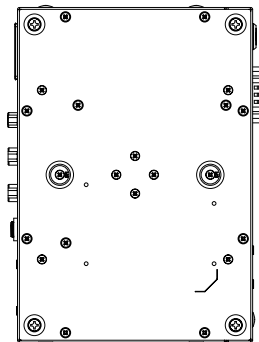
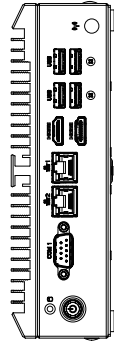
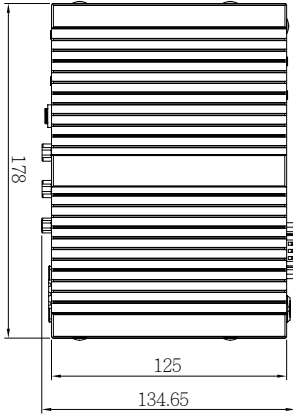
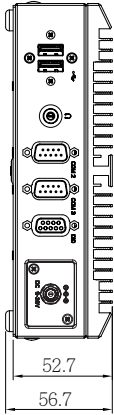

1.1 Specifications

System	QBiX-Pro-TGLA1135G7H-A2 (QP-1135A-SI)	QBiX-Pro-TGLA1115G4EH-A2 (QP-1115A-SI)
Dimension	System Size : 178W x 125D x 52.7H (mm)	
CPU	Intel® Core™ i5-1135G7 Processor 10nm SuperFin, 4 cores, 8 threads, up to 4.2 GHz	Intel® Core™ i3-1115G4E Processor 10nm SuperFin, 2 cores, 4 threads, up to 3.9 GHz
Chipset	SoC	
Memory	2 x DDR4 SO-DIMM sockets, Max. Capacity 64 GB Support Dual channel DDR4 3200 MHz memory modules	
Ethernet	2 x GbE LAN Ports (Intel® I219V and Intel® I211AT)	
Graphic support	Integrated Graphics Processor - Intel® Iris® X ^e Graphics : 2 x HDMI 2.0 ports, supporting a maximum resolution of 4096x2160 @60Hz (2 independent display outputs)	Integrated Graphics Processor - Intel® UHD Graphics for 11th Gen Intel® Processors : 2 x HDMI 2.0 ports, supporting a maximum resolution of 4096x2160 @60Hz (2 independent display outputs)
Audio	Realtek® Audio Codec	
Storage	1 x 2.5" HDD/SSD (SATA 6Gb/s)	
Expansion Slots	1 x 2280 M.2 M-Key (PCIe x2, SATA 6Gb/s) 1 x 2230 M.2 E-Key (WiFi/BT) 1 x Full-size Mini PCIe with SIM slot (PCIe x1 + USB 2.0) -- support 3G/4G module	
Front I/O	2 x RJ45 LAN Ports 4 x USB 3.2 Gen 2x1 2 x HDMI 1 x Power button with LED 1 x HDD LED 1 x COM Port (RS-232/422/485 & RI/5V/12V)	
Rear I/O	2 x USB 2.0 2 x COM Ports (RS-232/422/485) 1 x GPIO (8 bits) 1 x Headphone Jack 1 x Screw Type DC Jack	
Side I/O	2 x External Antenna Holes (Optional)	

System	QBiX-Pro-TGLA1135G7H-A2 (QP-1135A-SI)	QBiX-Pro-TGLA1115G4EH-A2 (QP-1115A-SI)
TPM	—	
Power	+9V~36VDC (Adapter 19.5V/135W)	
Operation Temperature	Operating temperature: 0°C to 50°C Operating humidity: 0-90% (non-condensing) Non-operating temperature: -40°C to 85°C Non-operating humidity: 0%-95% (non-condensing) Use wide temperature range memory and storage	
Vibration During Operation	Operation: IEC 60068-2-64, 5 Grms, random, 5 ~ 500 Hz, 1 hr / Per Axis, with SSD/M.2 2280 Non-operation: IEC 60068-2-6, 2 G, Sine, 10 ~ 500 Hz, 1 Oct/min, 1 hr / Per Axis	
Shock During Operation	Operation: IEC 60068-2-27, 50 G, half sine, 11 ms duration, With SSD	
Packaging Content	Carton size: 505 x 333 x 231 (mm) Packing Capacity: 5pcs Including: Screw I Head for 2.5" HDD M3x8L x 4 (P/N: 25KSG-130081-K1R) Thermal Pad for Memory x 1 (P/N: 25ST3-200086-T5R) SATA Cable x 1 (P/N: 25CRI-070000-S9R) Power Cord : Optional (by region) PSU ADP 19.5V 135W 100-240VAC x 1 (P/N: 25EP4-201352-C1S)	
Order Information	System: 6BQP1135AMR-SI (Box packing)	System: 6BQP1115AMR-SI (Box packing)

Chapter 2

Chapter 2 – QBiX-Pro-TGLA1135G7H-A2 (QP-1135A-SI)
QBiX-Pro-TGLA1115G4EH-A2 (QP-1115A-SI)
Industrial Embedded System Kit

2.1 Dimension

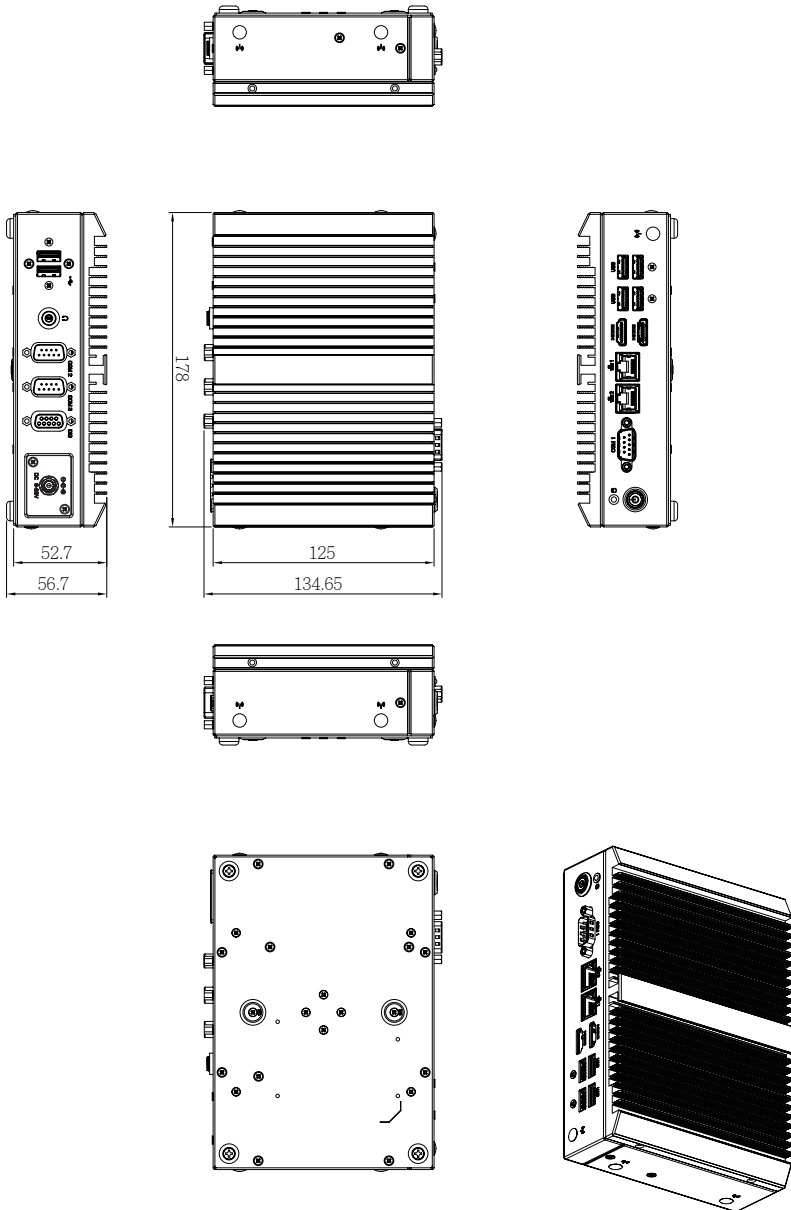

2.2 Getting Familiar with Your Unit

[Front Side]

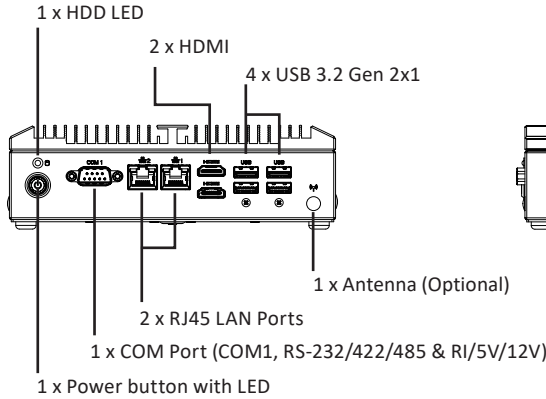

[Left Side]

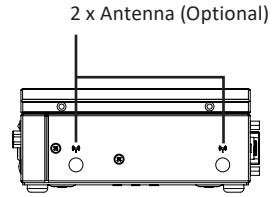

[Rear Side]

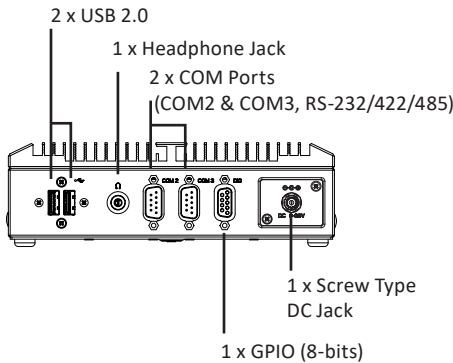

[Right Side]

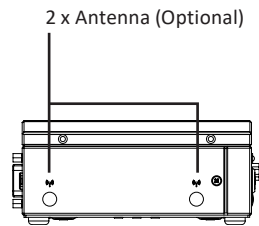

[Install]

- * Before opening the case, make sure to unplug the power cord.
- * Before Connecting the power, make sure to fasten the case securely.

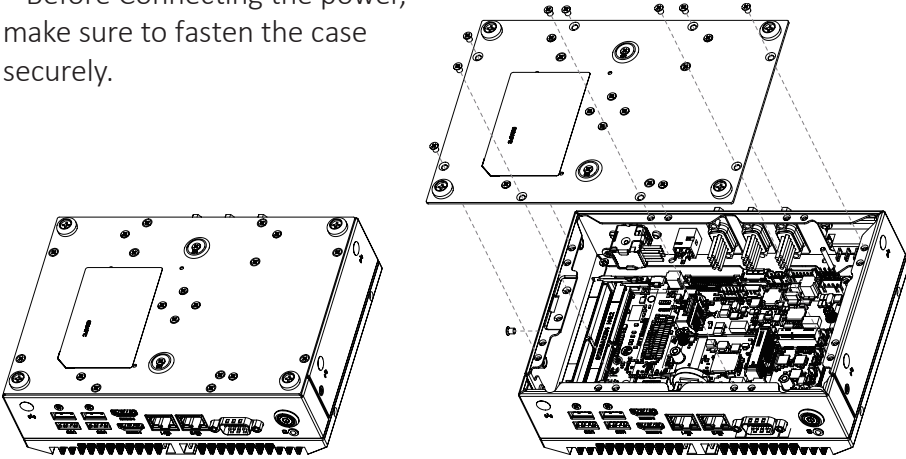

[Bottom PCB Side]

Information	
A	2 x DDR4 SO-DIMM sockets, DDR4 3200 MHz, Max. Capacity 64 GB
B	1 x Mini PCIe slot (PCIe x1 + USB2.0) with SIM Slot

Information	
C	1 x M.2 slot (Support NGFF-2280 SATA)
D	1 x M.2 slot (Support NGFF-2230 WiFi/BT)
E	support 2.5" Hard drive/SSD

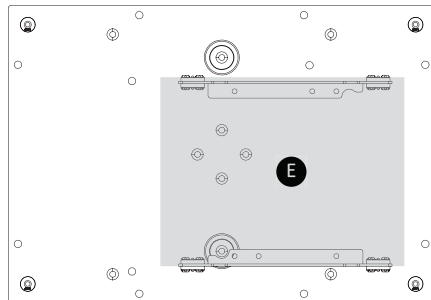
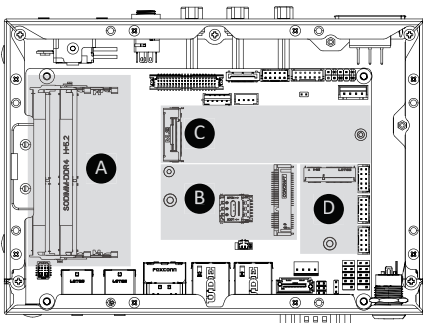

2.3 A) Wireless Module: How to safely install the Module (Wireless Module inclusion may vary based on local distribution)

①

Carefully insert the wireless module into the M.2 slot

小心地將無線模組安裝於M.2插槽中。

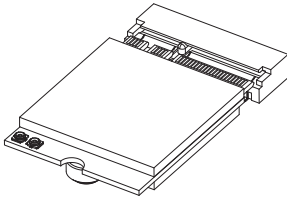

②

Lock the screw in the middle.

鎖入固定於無線模組中央頂端的螺絲。

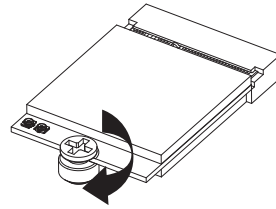

③

Install the antenna on the left side of the connection wireless module down.

向下安裝連結於無線模組左側頂端天線。

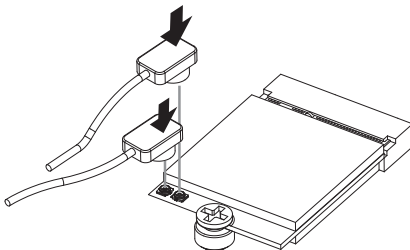

2.4 B) Memory Installation: DDR4 SO-DIMM

1

Carefully insert SO-DIMM memory modules.

小心地由下至上將 SO-DIMM 記憶體安裝於記憶體插槽。

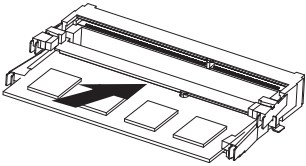

2

Push down until the modules click into place.

當記憶體固定於插槽後，再輕輕下壓至定點。

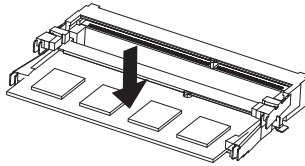

3

Carefully insert SO-DIMM memory modules.

安裝下層記憶體後，重覆前述動作安裝上層記憶體。

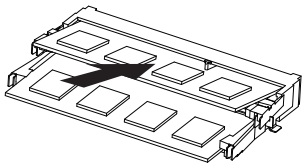

4

Push down until the modules click into place.

當記憶體固定於插槽後，再輕輕下壓至定點。

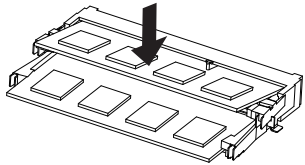

2.5 Antenna Installation (Antenna inclusion may vary based on local distribution)

1

Carefully insert the antennas into the connectors.
小心地將天線插入天線插孔中。

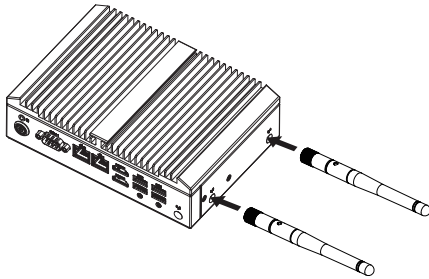
**2**

Turn the antennas clockwise until they are completely secure on the connectors.

握住天線接頭底端，按順時針方向將天線旋入插孔中牢牢固定。

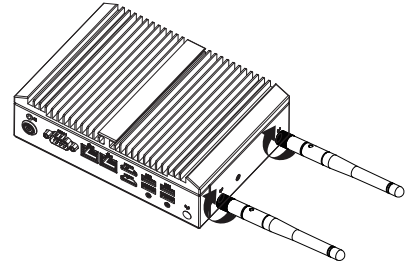
**3**

Flip up the antenna heads so that they are perpendicular to the machine.

栓緊後請將天線拉起朝上呈垂直狀。

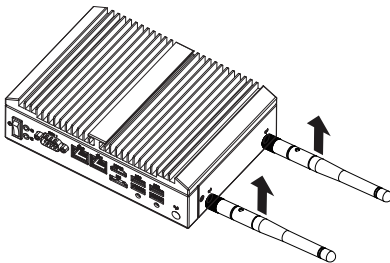

2.6 Cable Pin-define

1. DB9 COM (25CF8-210620-S9R)

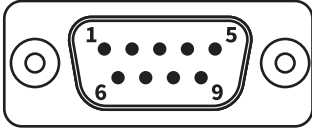

DB9 Pin Define

DB9 Pin	RS-232	RS-422 Full Duplex	RS-485 Half Duplex
1	DCD	TXD-	D-
2	RXD	TXD+	D+
3	TXD	RXD+	-
4	DTR	RXD-	-
5	GND		
6	DSR	-	-
7	RTS	-	-
8	CTS	-	-
9	RI	-	-

2. DBP DIO (25CR5-150606-S9R)

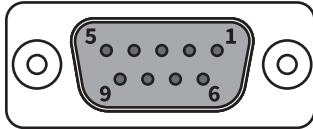

DBP DIO Pin	Pin Name
1	GPIO-output_1
2	GPIO-input_1
3	GPIO-output_2
4	GPIO-input_2
5	GPIO-output_3
6	GPIO-input_3
7	GPIO-output_4
8	GPIO-input_4
9	5V

2.7 Support

- For a list of tested memory, M.2, 2.5" SSD, wireless adapters and OS supported, go to: <http://www.gigaipc.com>
- To download the latest drivers and BIOS updates, go to: <http://www.gigaipc.com>
- For product support, go to: <http://www.gigaipc.com>

2.8 Safety and Regulatory Information

Risk of explosion if the battery is replaced with an incorrect type. Batteries should be recycled where possible.

Disposal of used Batteries must be in accordance with local environmental regulations.

Failure to use the included Power Adapter may violate regulatory compliance and may expose the user to safety hazards.

HDMI™
HIGH DEFINITION MULTIMEDIA INTERFACE



At the end of its serviceable life, this product should not be treated as household or general waste. It should be handed over to the applicable collection point for the recycling of electrical and electronic equipment, or returned to the supplier for disposal.

Chapter 3

Chapter 3 – Hardware Information

3.1 Jumpers and Connectors

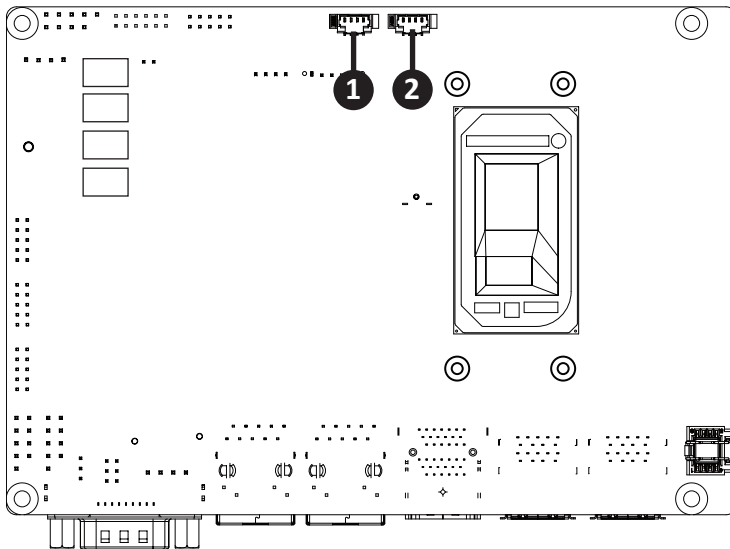
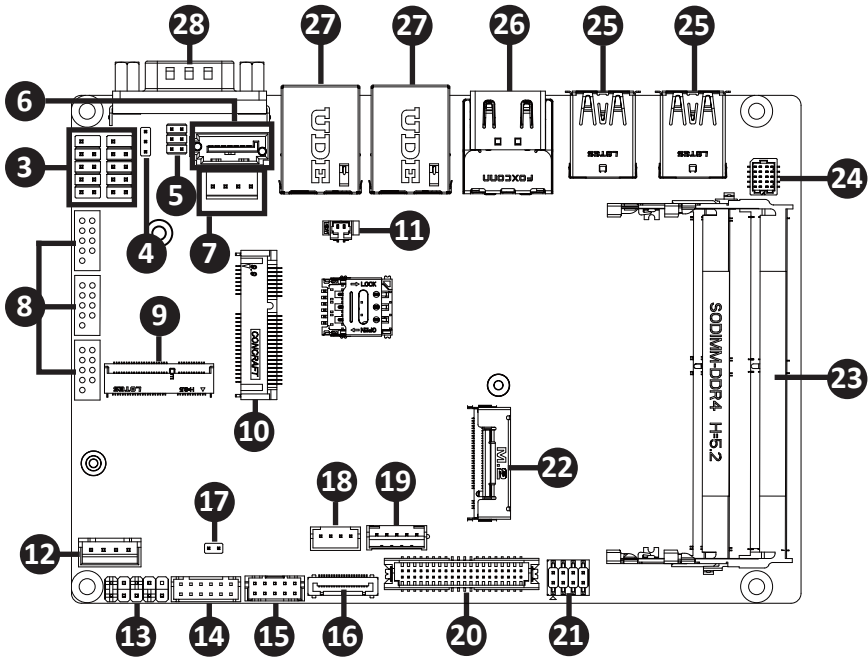

No	Code	Description
1	SYS_FAN	System fan connector
2	CPU_FAN	CPU fan connector
3	FUSB1, FUSB2	USB2.0 headers
4	AT_CN	AT/ATX power mode select jumper
5	JCOM1	COM 1 (COM RI# pin RI#/5V/12V Select)
6	SATA0	SATA 6Gb/s connector
7	SATAPW0	SATA power connector
8	COM2, COM3, COM4	Serial port header (RS-232/422/485)
9	M2E	M.2 Slot, E-key, NGFF2230, WiFi & Bluetooth module
10	MPCIE	Mini PCIe full size, support 3G/4G module
11	BATTERY	Battery cable connector
12	DC_IN	DC IN 1x4 pin power connector
13	SYS_PANEL	Front panel header
14	GPIO_CNT	General purpose input / output header
15	FP_AUDIO	Front Audio connector
16	PCIEX1	PCIe Gen3 x1 connector
17	ME	ME Enable jumper
18	SPK_OUT	Speaker out connector
19	BKL_CN	Back light brightness control header
20	LVDS	LVDS connector
21	LSW	LVDS resolution jumper
22	M2M	M.2 Slot, SATA/PCIex2, NGFF 2280

No	Code	Description
23	SODIMM1 SODIMM2	DDR4 SO-DIMM Slot
24	TPM	Trusted Platform Module connector
25	USB31_1 USB31_2	USB 3.2 Gen2x1 connector
26	HDMI_21	HDMI connector
27	LAN1, LAN2	LAN connector
28	COM1	Serial Port

3.2.1 SYS_FAN (System fan connector)

1

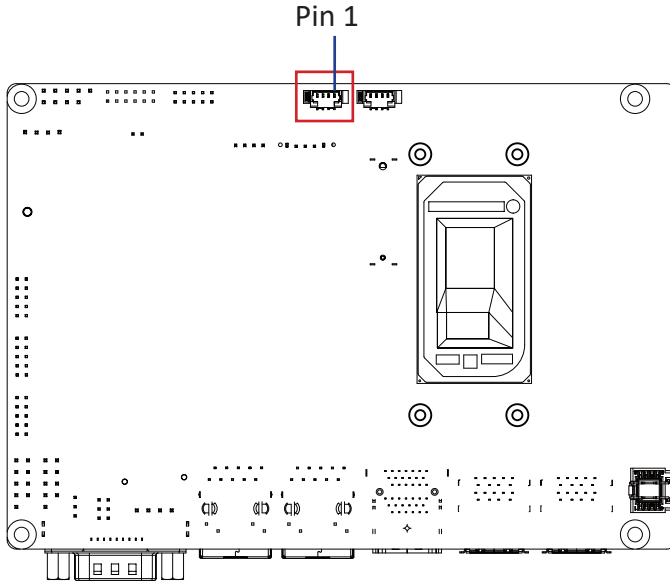

System fan Connector

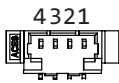

Pin No.	Definition
1	GND
2	12V
3	Detect
4	Speed control

Connector PN	Vendor
85205-0470N	ACES
A1250WV-S-04PC	JOINT-TECH

3.2.2 CPU_FAN (CPU fan connector)

2

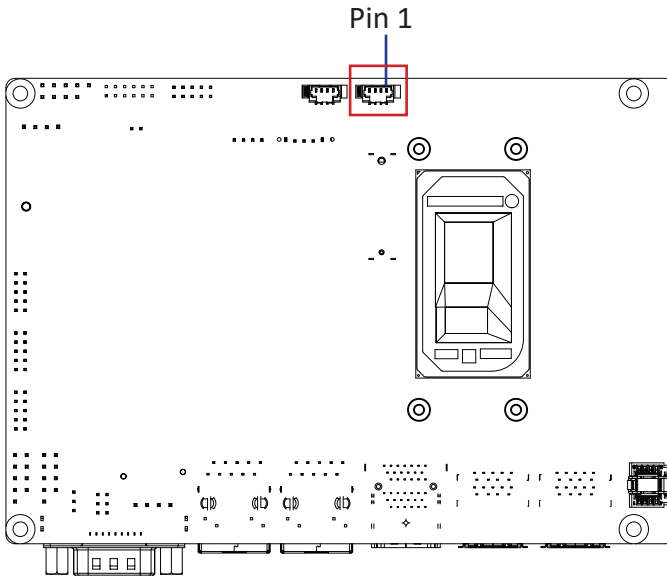

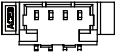
CPU fan Connector	
4321	
	

Connector PN	Vendor
85205-0470N	ACES
A1250WV-S-04PC	JOINT-TECH

Pin No.	Definition
1	GND
2	12V
3	Detect
4	Speed control

3.2.3 FUSB1, FUSB2 (USB2.0 headers)

3

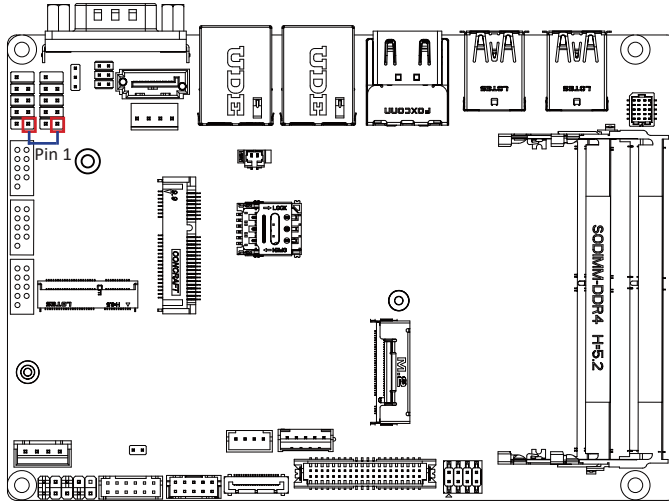

USB 2.0 Header



Connector PN

210-92-05GB04

PH10R53BAZ009

Vendor

PINREX

HORNGTONG

Pin No.	Definition
1	5V
2	5V
3	DX-
4	DY-
5	DX+
6	DY+
7	GND
8	GND
9	No Pin
10	No Connect

3.2.4 AT_CN (AT/ATX power mode select jumper)

4

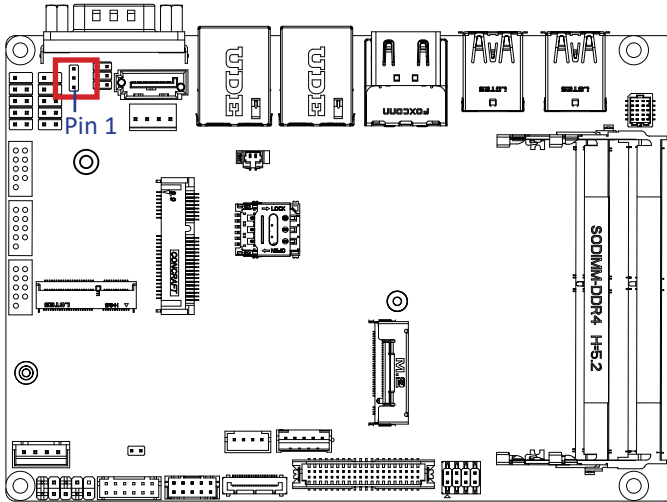

AT/ATX power mode select jumper	

Connector PN	Vendor
220-96-03GB01	PINREX
PH03N2-7BAN000	HORNGTONG

Pin No.	Definition
1	AT MODE
2	TXD5
3	ATX MODE

Jumper setting
 1-2 Close : AT mode.
 2-3 Close : ATX mode.(Default setting)

3.2.5 JCOM1 (COM1 RI# pin RI#/5V/12V Select)

5

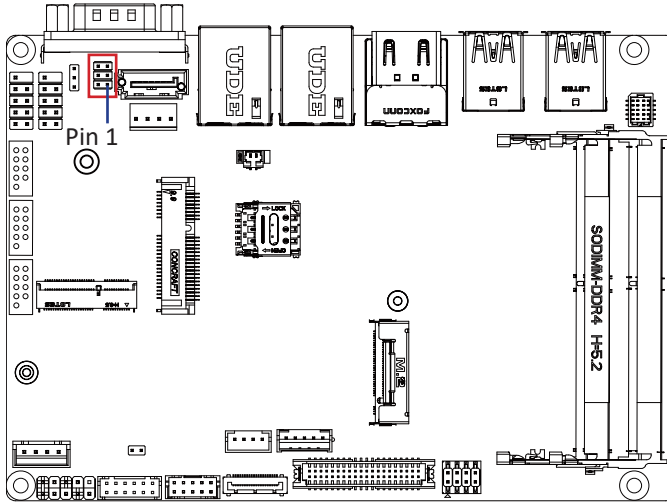

JCOM1 Jumper Select	
<p>6 5 0 0 0 0 2 1</p>	1-2 Close: 5V (Power COM)
<p>6 5 0 0 0 0 2 1</p>	3-4 Close: RI (Stand COM) (Default-Setting)
<p>6 5 0 0 0 0 2 1</p>	5-6 Close: 12V (Power COM)

Connector PN	Vendor
220-97-03GB01	PINREX
PH06N53BAZ000	HORNGTONG

3.2.6 SATA0 (SATA 6Gb/s connector)

6

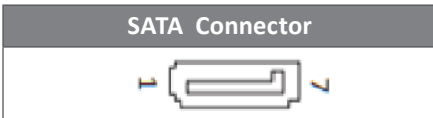
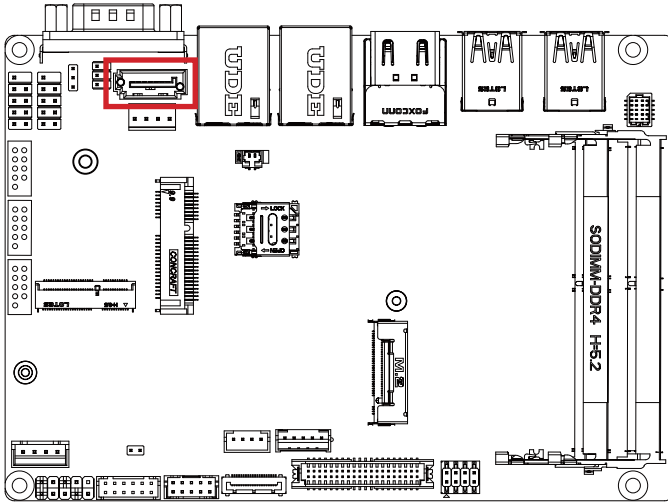

Pin No.	Definition
1	GND
2	TXP
3	TXN
4	GND
5	RXN
6	RXP
7	GND

Connector PN	Vendor
WATF-07DBLBA1UW	WINWIN

3.2.7 SATAPW0 (SATA power connector)

7

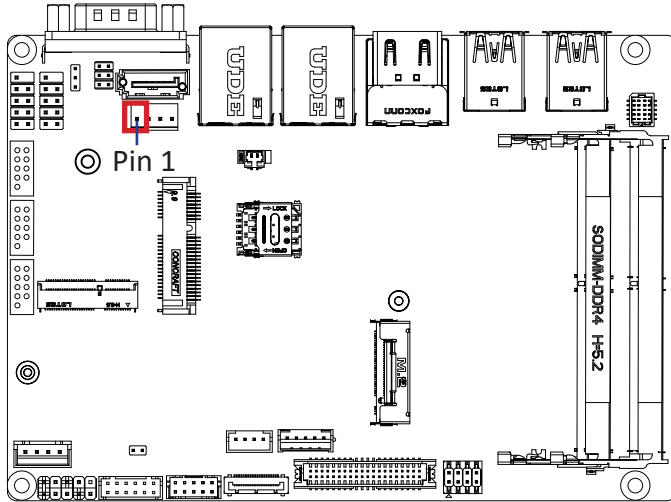

Hard Disk Power Connector	

Connector PN	Vendor
743-81-04TW00	PINREX
WF04Q2-3BJQ000	HORNGTONG

Pin No.	Definition
1	12V
2	GND
3	GND
4	5V

3.2.8 COM2, COM3, COM4 (Serial port header, RS-232/422/485)

8

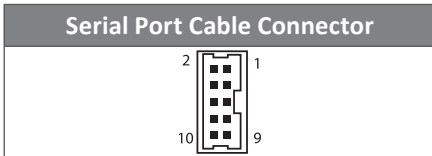
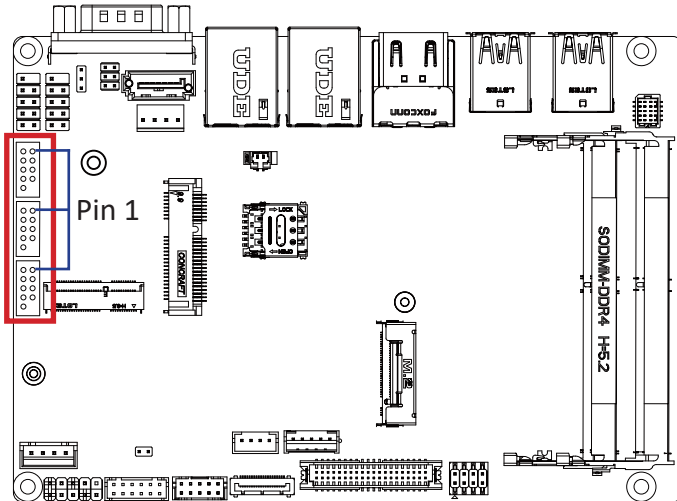

Connector PN	Vendor
725-81-10TW00	PINREX
A2004WV-2X05P46	JOINT-TECH

Pin No.	Definition	Pin No.	Definition
1	RXD	6	GND
2	DCD	7	CTS
3	DTR	8	RTS
4	TXD	9	No Connect
5	DSR	10	RI/ 5V/ 12V

3.2.9 M2E (M.2 Slot, E-key, NGFF2230, WiFi & Bluetooth module)

9

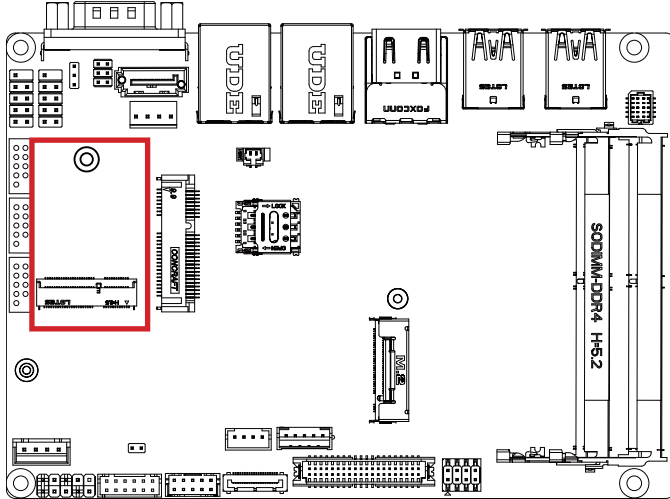

3.2.10 MPCIE (Mini PCIe full size, support 3G/4G module)

10

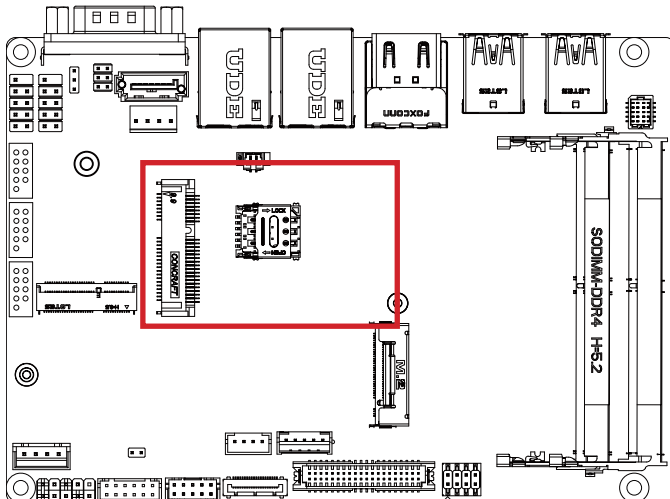

3.2.11 BATTERY (Battery cable Connector)

11

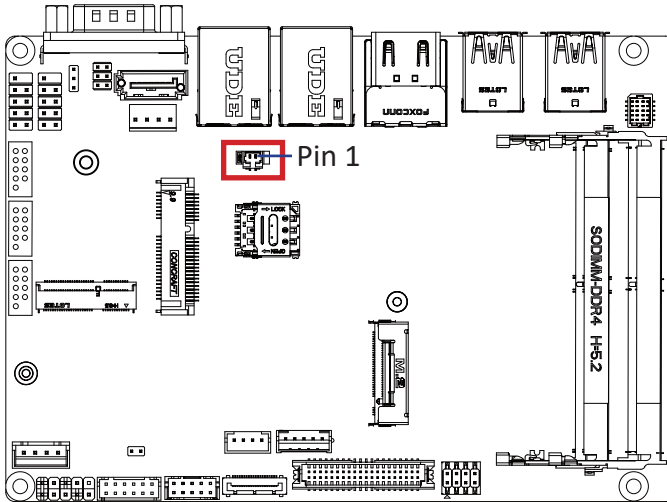

Battery cable Connector	

Connector PN	Vendor
85205-0270L	ACES
A1250WV-S-02PC	JOINT-TECH

Pin No.	Definition
1	3.3V
2	GND

3.2.12 DC_IN (DC IN 1x4 pin power connector)

12

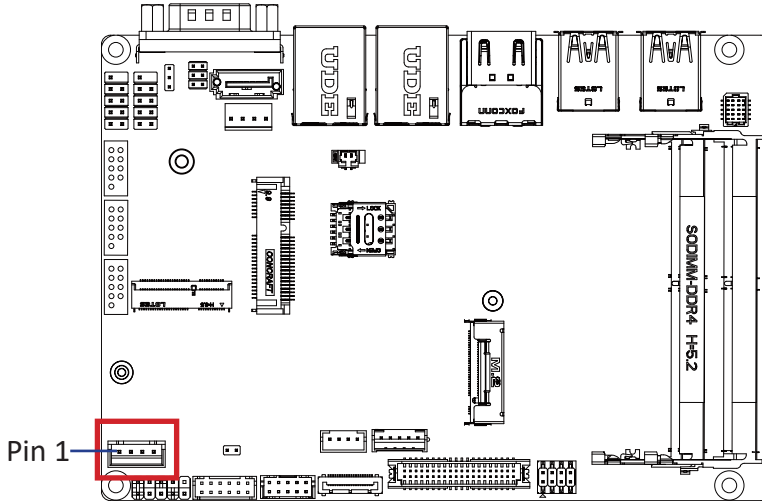

DC IN connector	

Connector PN	Vendor
753-81-04TW00	PINREX

Pin No.	Definition
1	GND
2	Power
3	Power
4	GND

3.2.13 SYS_PANEL (Front panel header)

13

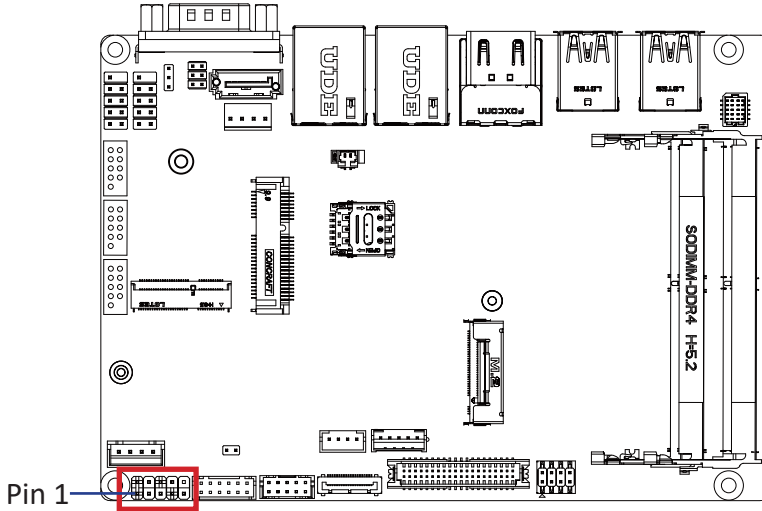

System Panel Header	
2	10
1	9

Connector PN	Vendor
210-92-05G111	PINREX

Pin No.	Definition
1	HDD LED+
2	Power LED+
3	HDD LED-
4	Power LED-
5	GND
6	Power Button+
7	Reset Button
8	Power Button-
9	No Connect
10	No Pin

3.2.14 GPIO_CNT (General Purpose input/output header)

14

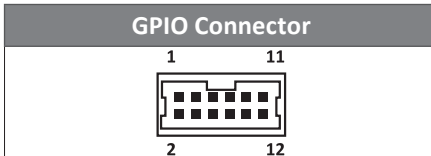
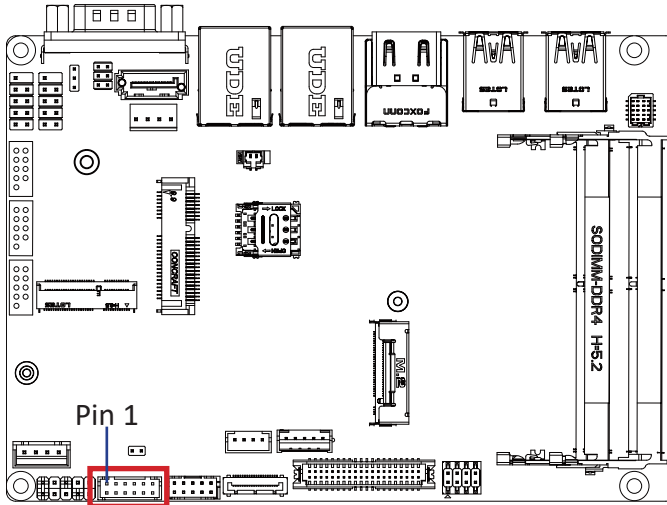

Pin No.	Definition
1	GPO1
2	GPI1
3	GPO2
4	GPI2
5	GPO3
6	GPI3
7	GPO4
8	GPI4
9	SMB_CLK

Pin No.	Definition
10	SMB_DATA
11	5V
12	GND

Connector PN	Vendor
725-81-12TW00	PINREX
A2004WV-2X06P46	JOINT-TECH

3.2.15 FP_AUDIO (Front Audio connector)

15

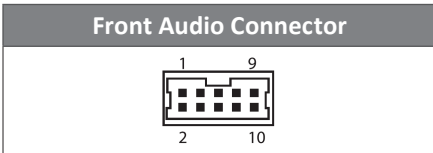
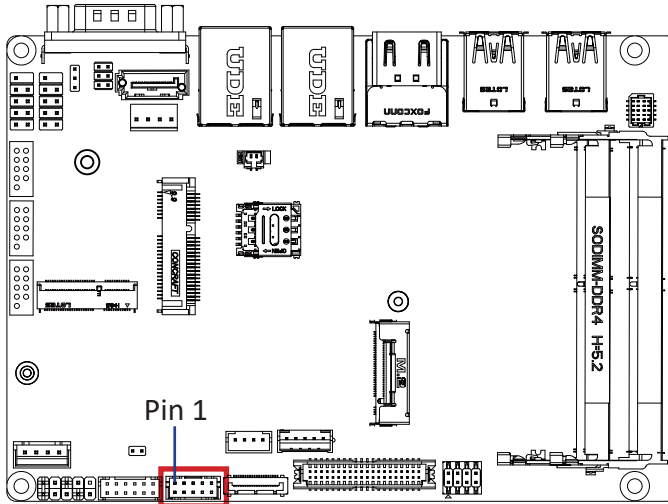

Pin No.	Definition	Pin No.	Definition
1	MIC_L	6	MIC_JD
2	GND	7	FAUDIO_JD
3	MIC_R	8	No Connect
4	Detect	9	HPOUT_L
5	HPOUT_R	10	GND

Connector PN	Vendor
725-81-10TW00	PINREX
A2004WV-2X05P46	JOINT-TECH

3.2.16 PCIEX1 (PCIe Gen3 x1 connector)

16

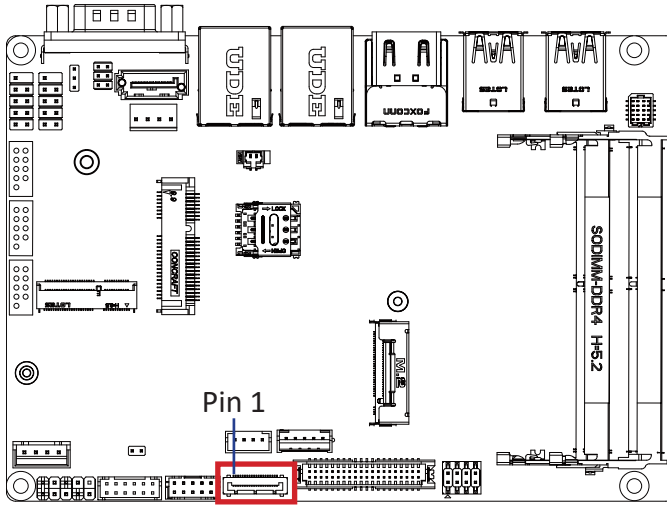

PCIe Gen3 x1 Connector

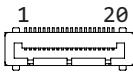



Pin No.	Definition	Pin No.	Definition
1	SRC_DP	11	SMDATA
2	SRC_DN	12	CLK_REQ#
3	GND	13	PLTRST#
4	TX+	14	PEWAKE#
5	TX-	15	SLP_S3#
6	GND	16	GND
7	RX+	17	GND
8	RX-	18	+V12A
9	GND	19	+V12A
10	SMCLK	20	+V12A

Connector PN	Vendor
115B20-100020-G4-R	STARCONN

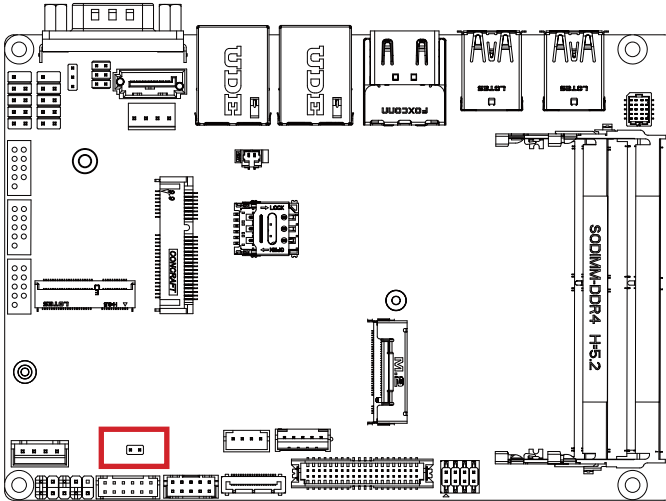

3.2.17 ME (ME Enable jumper)

17



ME Enable Connector	
	

Connector PN	Vendor
220-96-02GB01	PINREX

ME Enable jumper	
	Default
	Enable

3.2.18 SPK_OUT (Speaker out connector)

18

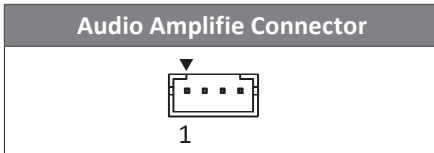
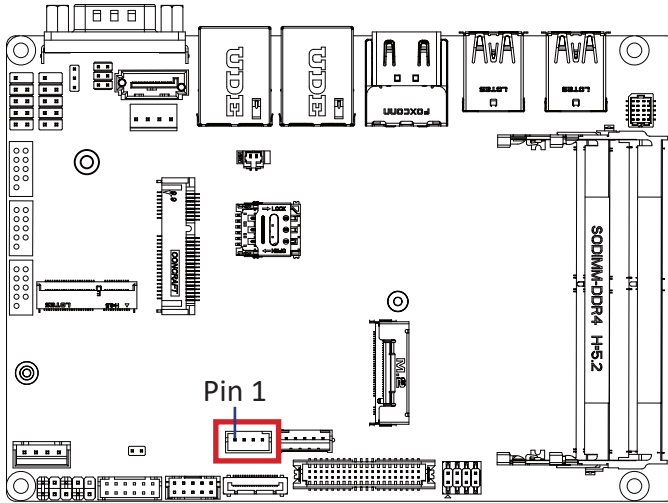

Pin No.	Definition
1	Speaker Out L+
2	Speaker Out L-
3	Speaker Out R-
4	Speaker Out R+

Connector PN	Vendor
721-81-045W00	PINREX
A2001WV-04P146	JOINT-TECH

3.2.19 BKL_CN (Back light brightness control header)

19

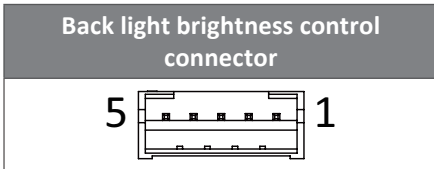
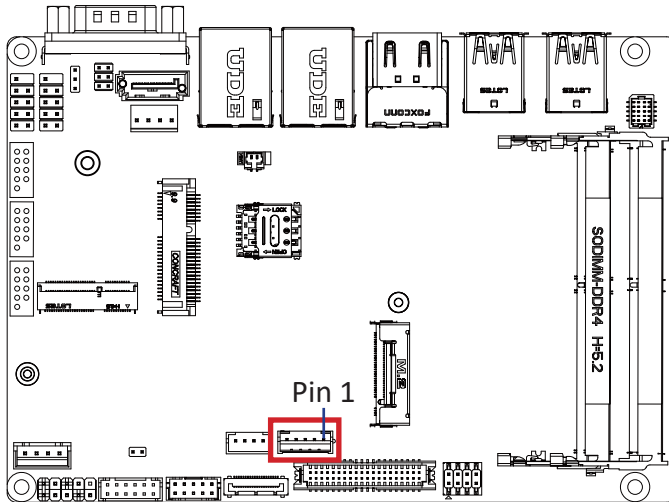

Connector PN	Vendor
721-81-05TW00	PINREX
A2001WV-05P146	JOINT-TECH

Pin No.	Definition
1	5V
2	PWM
3	Back Light Enable
4	GND
5	12V

3.2.20 LVDS (LVDS connector)

20

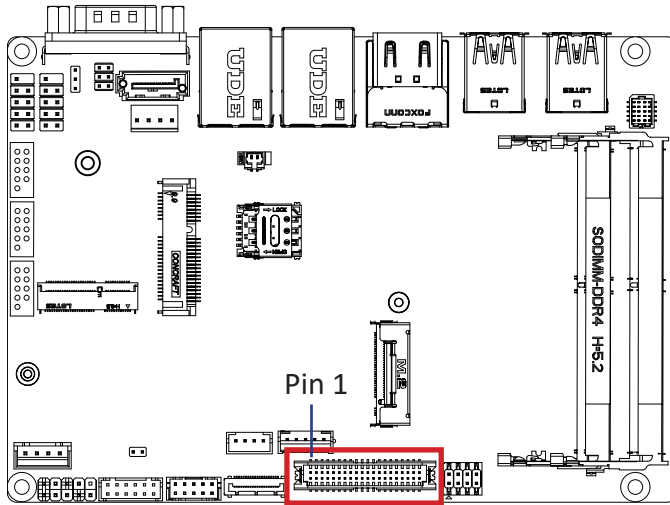

LVDS Connector

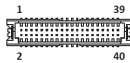

Pin No.	Definition	Pin No.	Definition
1	3.3V	21	A5+
2	5V	22	A4+
3	3.3V	23	A5-
4	5V	24	A4-
5	SPECO	25	GND
6	SPEDO	26	GND
7	GND	27	A7+
8	GND	28	A6+
9	A1+	29	A7-
10	A0+	30	A6-
11	A1-	31	GND
12	A0-	32	GND
13	GND	33	CLK2+
14	GND	34	CLK1+
15	A3+	35	CLK2-

Pin No.	Definition	Pin No.	Definition
16	A2+	36	CLK1-
17	A3-	37	GND
18	A2-	38	GND
19	GND	39	12V
20	GND	40	12V

Connector PN	Vendor
712-76-40GWEO	PINREX
A1252WV-SF-2X20PD01	JOINT-TECH









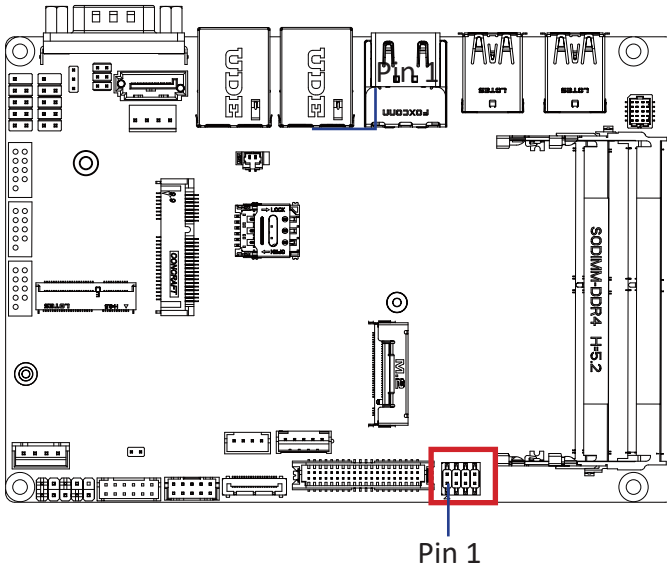







For each model support LVDS function.
 But below model no need to add.
 A0~A3 is odd channel 0~3, A4~A7 is even channel.

Note: *The LVDS output connector of the unit is only intended to be connected to an UL/IEC/EN approval equipment with fire enclosure.

3.2.21 LSW (LVDS resolution jumper)

21



LVDS Resolution Jumper			
Jumper Setting	Resolution	Jumper Setting	Resolution
1 	800 x 600 18bit	1 	1366 x 768 24bit
1 	1024 x 768 18bit	1 	1440 x 900 24bit
1 	1024 x 768 24bit	1 	1400 x 1050 24bit
1 	1024 x 600 18bit	1 	1600 x 900 24bit
1 	1280 x 800 18bit	1 	1680 x 1050 24bit
1 	1024 x 600 18bit	1 	1600 x 1200 24bit
1 	1280 x 1024 24bit	1 	1920 x 1080 24bit
1 	1366 x 768 18bit	1 	1920 x 1200 24bit

Connector PN	Vendor
222-97-04GBE1	PINREX

3.2.22 M2M (M.2 Slot, SATA/PCIeX2, NGFF 2280)

22

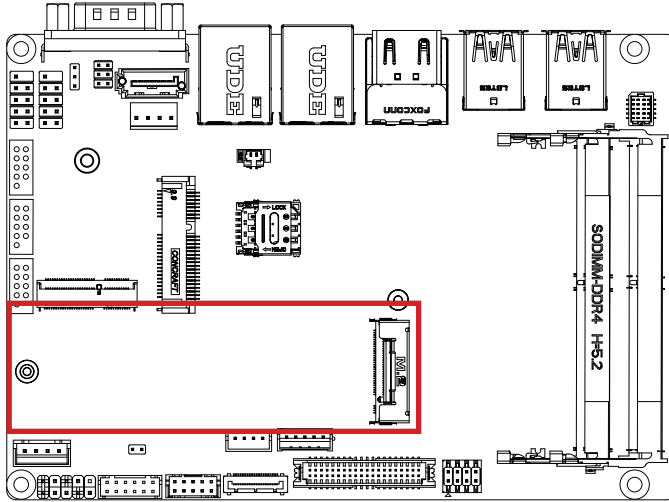

3.2.23 SODIMM1, SODIMM2 (DDR4 SO-DIMM Slot)

23

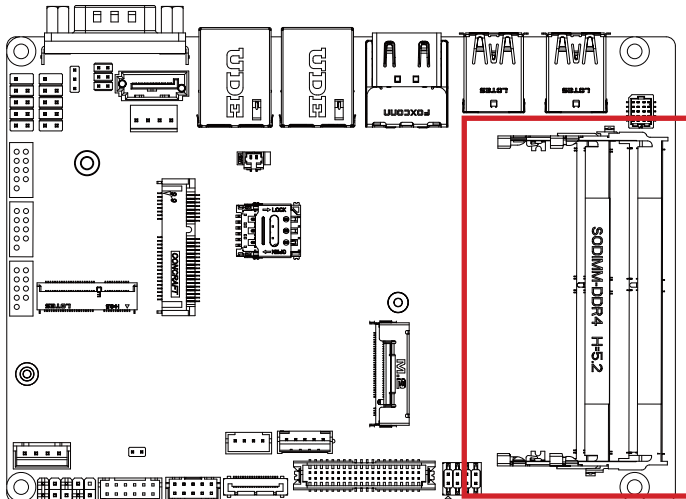

3.2.24 TPM (Trusted Platform Module Connector)

24

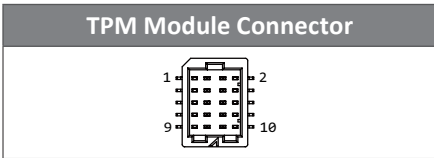
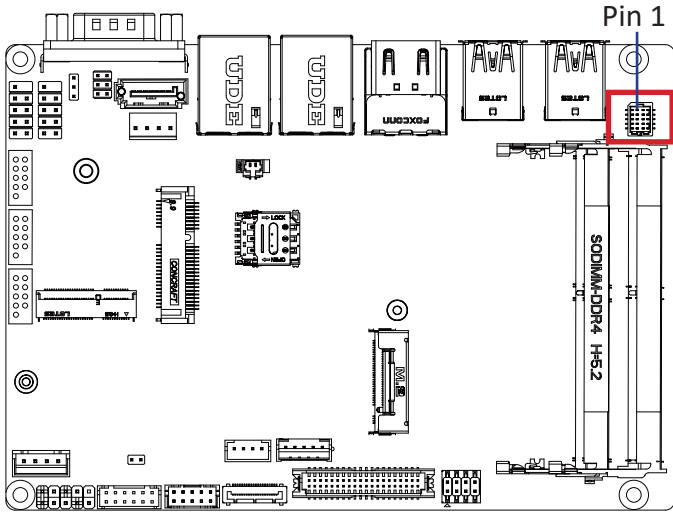

Connector PN	Vendor
87216-1004-06	ACES

Pin No.	Definition
1	SPI_CS#2
2	TPM_SO
3	TPM_RST#
4	TPM_SI
5	NC
6	TPM_CLK
7	NC
8	NC
9	+V3.3A
10	GND

Chapter 4

Chapter 4 – BIOS

4.1 Introduction

BIOS (Basic input/output system) provides hardware detailed information and boot-up options, which include firmware to control, set-up and test all hardware settings. Therefore, BIOS is the communication bridge between OS/application software and hardware.

4.1.1 How to Entering into BIOS menu

Once the system is power on, press the key as soon as possible to access into BIOS Setup program.

4.1.2 Function Keys to setup in BIOS Setup program

Function keys	Description
→←	Select Screen
↑↓	Select Item
Enter	Execute command or enter the submenu
+	Increase the numeric value or make changes
—	Decrease the numeric value or make changes
F1	General Help
F2	Previous Values
F3	Load Optimized Defaults Settings
F4	Save changes & Exit the BIOS Setup program
ESC	Exit the BIOS Setup program

4.2 The Main Menu

The main menu shows the basic system information. Use arrow keys to move among the items.

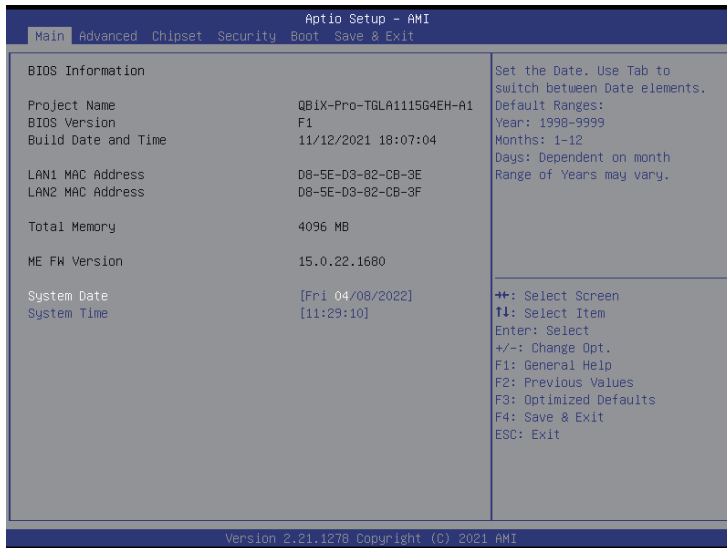

Items	Description
Project Name	Shows Project name information
BIOS Version	Shows the BIOS version of the system
Build Date and Time	Shows the Build Date and Time when the BIOS was created.
LAN1 MAC Address	Shows LAN1 MAC Address information
LAN2 MAC Address	Shows LAN2 MAC Address information
Total Memory	Shows the total memory size of the installed memory
ME FW version	Shows ME firmware version
System Date	Set the Date for the system (Format : Week - Month - Day - Year)
System Time	Set the time for the system (Format : Hour - Minute - Second)

4.3 Advanced

The Advanced menu is to configure the functions of hardware settings through submenu. Use arrow keys to move among the items, and press <Enter> to access into the related submenu.

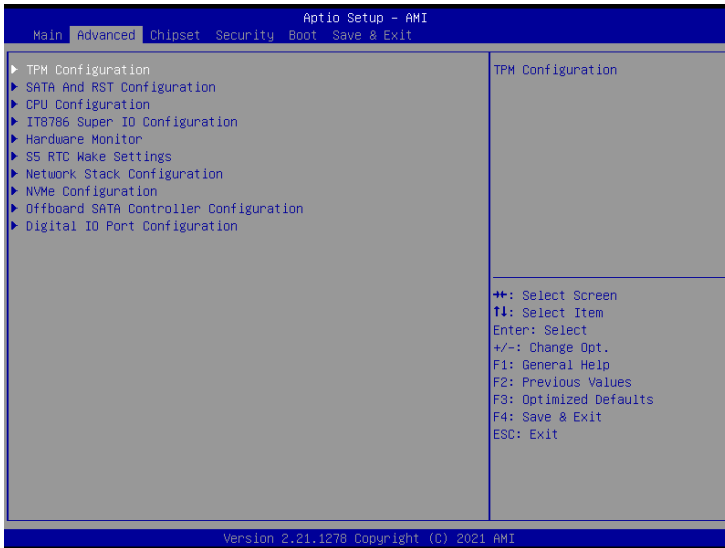

4.3.1 TPM Configuration

Use TPM Configuration submenu to choose TPM interface.



Item	Description
TPM Device Selection	PTT : Internal TPM (Default setting) dTPM : External TPM (When using External TPM module or having TPM chip on MB)

Trusted Computing : Shows TPM information, and TPM module configuration setting.



Item	Description
Security Device support	Enabled : Enables TPM feature (Default setting) Disabled : Disables TPM feature
Item	Description
Pending operation	None : No execution will be conducted (Default setting) TPM clear : Set to clear data on TPM

4.3.2 SATA And RST Configuration

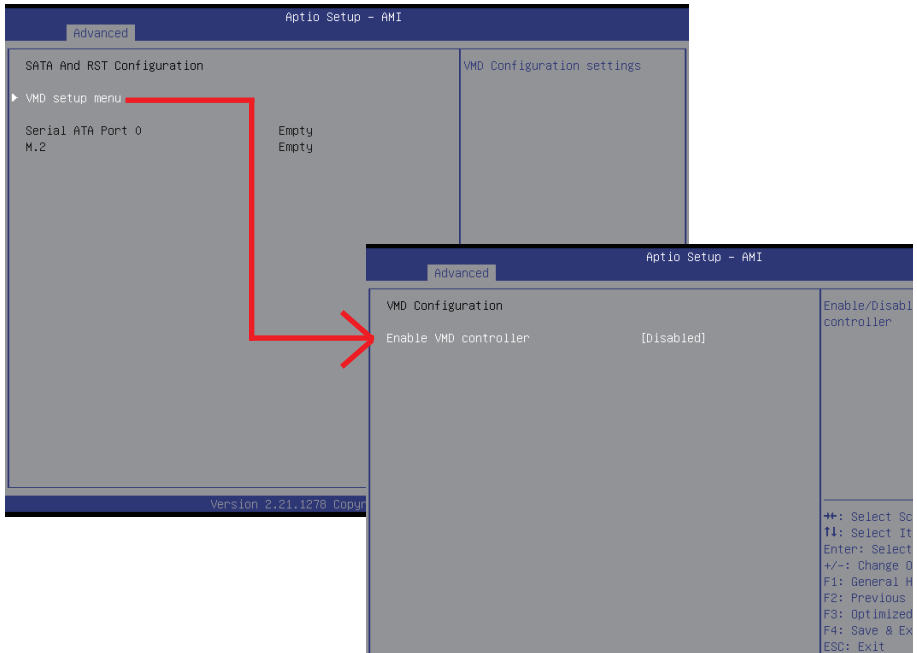

Item	Description
VMD setup menu / Enable VMD controller	Intel VMD feature helps you to control and manage NVMe PCIe SSD. Enabled : Enables Intel VMD feature Disabled : Disables Intel VMD feature (Default setting)
Serial ATA Port ()	shows 2.5" SATA HDD/SSD information
M.2	shows M.2 SATA interface SSD information

4.3.3 CPU Configuration

This submenu shows detailed CPU informations.

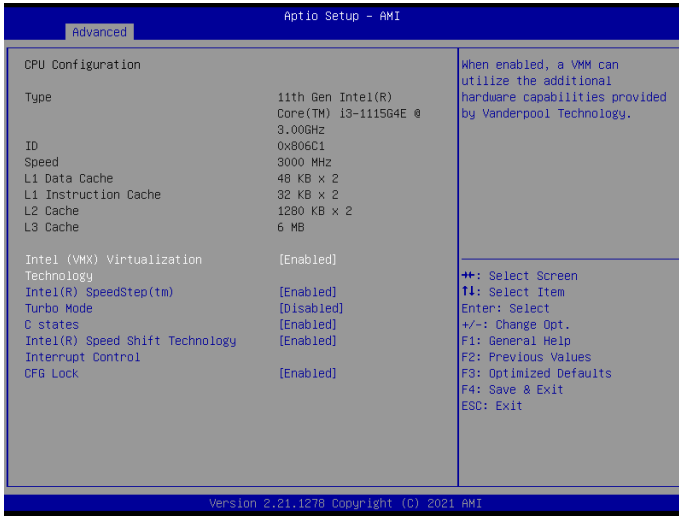

Item	Description
Intel (VMX) Virtualization Technology	Virtualization enhanced by Intel® Virtualization Technology will allow a platform to run multiple operating systems and applications in independent partitions. With virtualization, one computer system can function as multiple virtual systems. Enabled : Enables Intel Virtualization Technology (Default setting) Disabled : Disables Intel Virtualization Technology
Intel(R) SpeedStep(tm)	According to Intel CPU loading, Intel SpeedStep Technology will automatically adjust the CPU voltage and core frequency to decrease heat and power consumption for power saving. Enabled : Enables Intel SpeedStep Technology (Default setting) Disabled : Disables Intel SpeedStep Technology
Turbo Mode	Enabled : Enables Turbo Mode Disabled : Disables Turbo Mode (Default setting)
C states	Command CPU to enter into low power consumption mode when CPU is under idle mode. Enabled : Enables C states (Default setting) Disabled : Disables C states
Intel(R) Speed Shift Technology Interrupt control	To speed up CPU frequency transition time from basic frequency to maximum frequency. Enabled : Enables Intel(R) Speed Shift Technology Interrupt control (Default setting) Disabled : Disables Intel(R) Speed Shift Technology Interrupt control
CFG Lock	Enabled : Configure MSR 0xE2[15] , CFG Lock bit (Default setting) Disabled : Disables CFG Lock

4.3.4 IT8786 Super IO Configuration

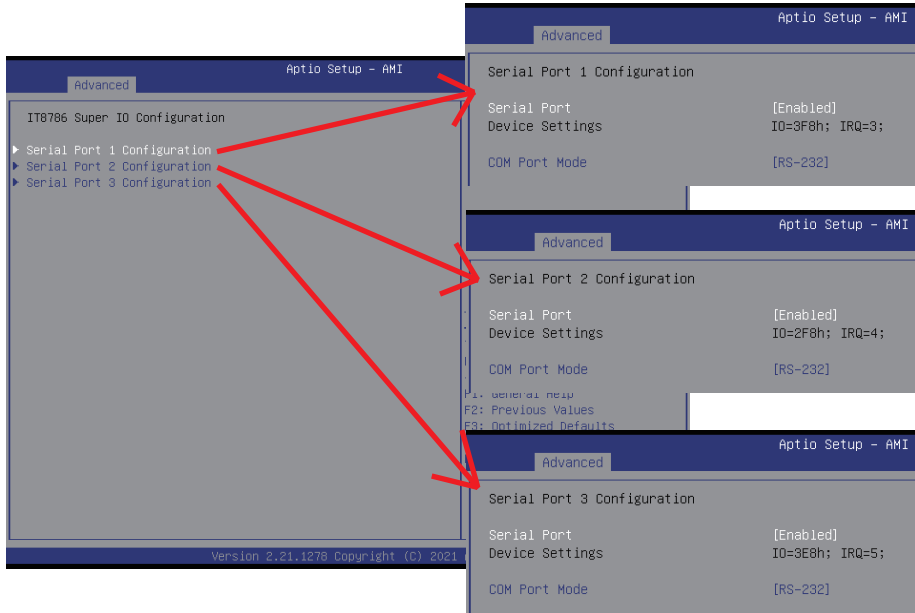

Item	Description
Serial Port 1 Configuration	Press [Enter] to configure advanced items : Serial Port :
Serial Port 2 Configuration	Enabled : Enables allows you to configure the serial port settings Disabled : if Disabled, displays no configuration for the serial port Device settings : Display the specified Serial Port base I/O address and IRQ
Serial Port 3 Configuration	COM Port Mode : Choose RS-232, RS-422, or RS-485 feature

4.3.5 Hardware Monitor

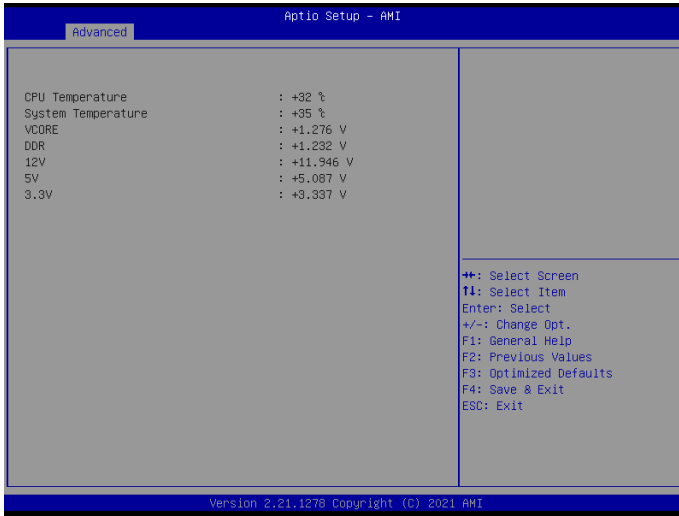

Item	Description
CPU Temperature	Shows current CPU temperature
System Temperature	Shows current system temperature

4.3.6 S5 RTC Wake Settings



Item	Description
<p>Wake system from S5</p>	<p>Enable or Disable System to wake on a specific time. Disabled : Disables system to wake on a specific time (Default setting) Fixed Time : Enables system to wake on a specific time (Format : hr : min : sec)</p>

4.3.7 Network Stack Configuration

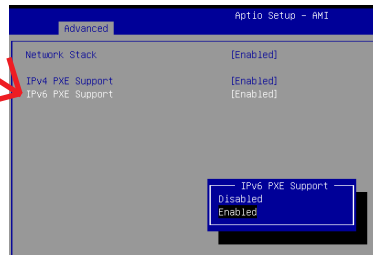
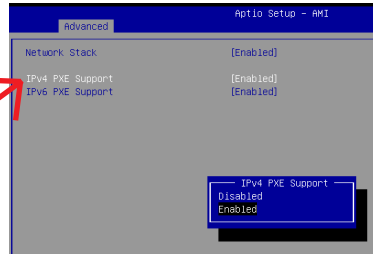
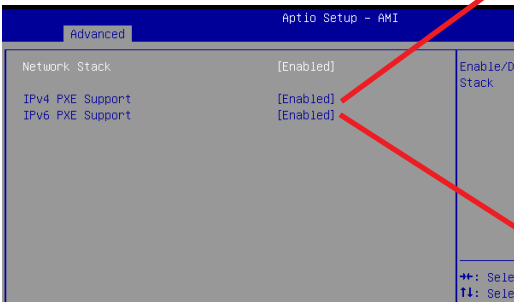
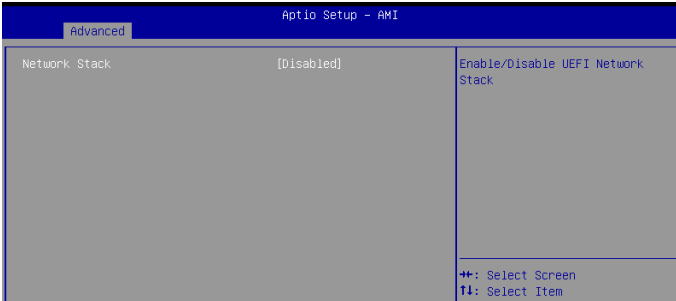

Item	Description
Network Stack	When system is power on, install LAN driver under UEFI mode Disabled : Disables UEFI Network Stack (Default setting) Enabled : Enables UEFI Network Stack
Ipv4 PXE Support	When Network stack is enabled : Disabled : Disables Ipv4 PXE Support Enabled : Enables Ipv4 PXE Support
Ipv6 PXE Support	When Network stack is enabled : Disabled : Disables Ipv6 PXE Support Enabled : Enables Ipv6 PXE Support

4.3.8 NVMe Configuration

NVMe Configuration shows information when your M.2 NVMe PCIe SSD is installed.



4.3.9 Offboard SATA Controller Configuration

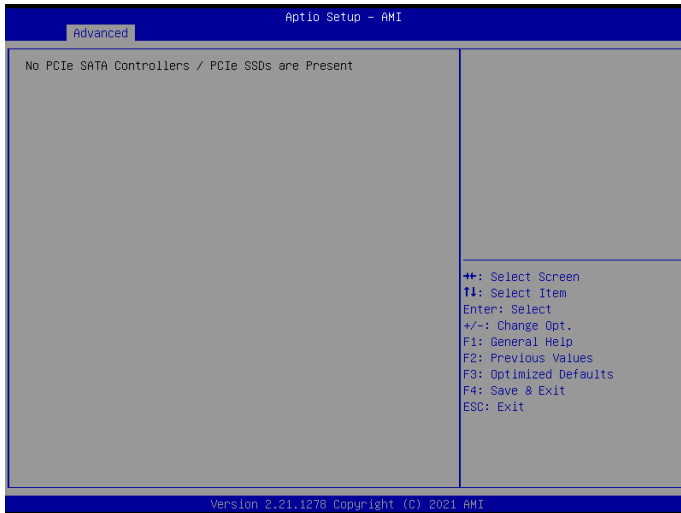

4.3.10 Digital IO Port Configuration

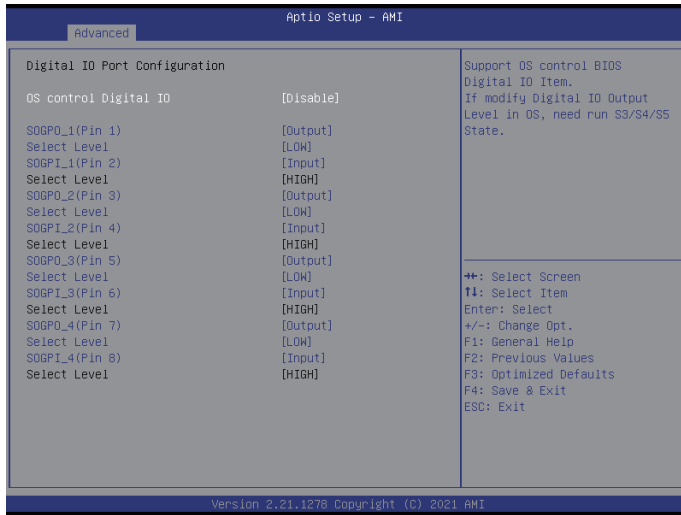

Item	Description
OS control Digital IO	<p>Disabled : If Digital IO Output value/level is modified in OS, they will not be memorized and kept. (Default setting)</p> <p>Enabled : If Digital IO Output value/level is modified in OS, they will be memorized and kept.</p>
SOGPO_1 (Pin 1) SOGPI_1 (Pin 2) SOGPO_2 (Pin 3) SOGPI_2 (Pin 4) SOGPO_3 (Pin 5) SOGPI_3 (Pin 6) SOGPO_4 (Pin 7) SOGPI_4 (Pin 8)	Configure Digital IO Input or Output values for each pin.

4.4 Chipset

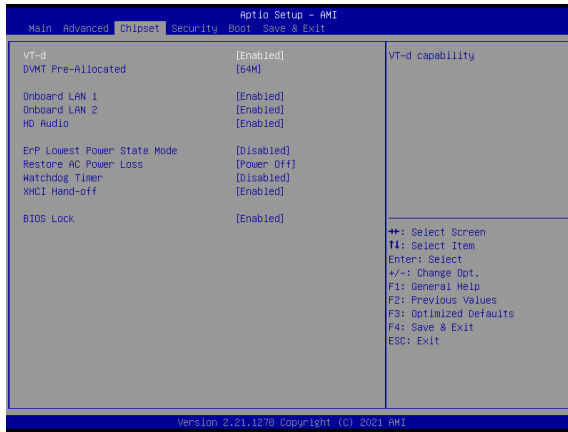

Item	Description
VT-d	Enabled : Enables VT-d function (Default setting) Disabled : Disables VT-d function
DVMT Pre-Allocated	Use DVMT Pre-Allocated to set the amount of system memory which is installed to the integrated graphics processor Option items : 32M , 64M(Default setting), 128M, 256M
Onboard LAN1 Onboard LAN2	Enable/Disable onboard LAN controller Enabled : Enables onboard LAN controller (Default setting) Disabled : Disables onboard LAN controller
HD Audio	Enable/Disable onboard audio controller Enabled : Enables onboard audio controller (Default setting) Disabled : Disables onboard audio controller
ErP Lowest Power State Mode	Enable/Disable power saving function Enabled : Enables ERP Lowest Power State Mode Disabled : Disabled ERP Lowest Power State Mode (Default setting)
Restore AC Power Loss	To set which option the system should returns if a sudden power loss occurred Power on : System power on when the power is back Power off : Do not power on when the power is back (Default setting) Last state : Restore the system to the state before power loss occurs
Watchdog Timer	Enable/Disable Watchdog Timer function Enabled : Enables Watchdog Timer function Disabled : Disabled Watchdog Timer function (Default setting)
XHCI Hand-off	Enable/Disable XHCI Hand-off function Enabled : Enables XHCI Hand-off function (Default setting) Disabled : Disables XHCI Hand-off function
BIOS Lock	Enable/Disable BIOS Lock function Enabled : Enables BIOS Lock function (Default setting) Disabled : Disabled BIOS Lock function

4.5 Security

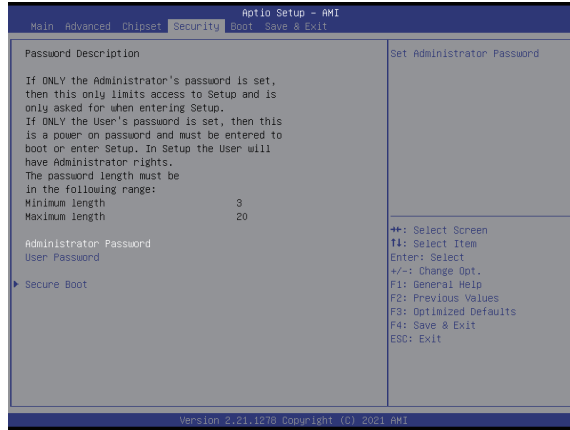

Item	Description
Administrator Password	To set up Administrator's password Minimum length : 3 Maximum length : 20
User Password	To set up User's password Minimum length : 3 Maximum length : 20
Secure Boot	Press <Enter> to configure the advanced items



Item	Description
Secure Boot	Secure Boot requires all the applications that are running during the booting process to be pre-signed with valid digital certificates Enabled : Enables Secure Boot function Disabled : Disables Secure Boot function (Default setting)
Secure Boot Mode	Standard : Standard mode Custom : Custom mode (Default setting)
Restore Factory Keys	To restore factory settings Yes : Agree to restore factory settings No : Cancel to restore factory settings
Reset To Setup Mode	Yes : Agree to setup mode No : Cancel to setup mode
Key Management	Enables expert users to modify Secure boot policy variables without full authentication Press <Enter> to configure the advanced items

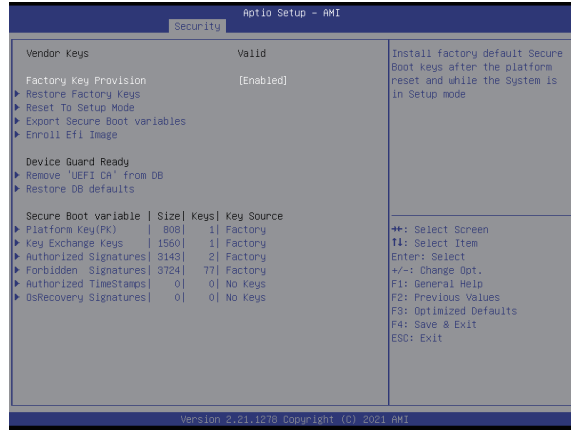

Item	Description
Factory Key Provision	Install factory default Secure Boot keys after the platform reset and while the system is in Setup mode Enabled : Enables Factory Key Provision (Default setting) Disabled : Disables Factory Key Provision
Restore Factory Keys	To restore factory settings Yes : Agree to restore factory settings No : Cancel to restore factory settings
Reset To Setup Mode	Yes : Agree to setup mode No : Cancel to setup mode
Export Secure Boot variables	Copy NVRAM content of Secure Boot variables to files in a root folder on a file system device
Enroll Efi Image	Allow the image to run in Secure Boot mode
Remove 'UEFI CA' from DB	To remove 'UEFI CA' from database Yes : Agree to remove 'UEFI CA' from database No : Cancel to remove 'UEFI CA' from database
Restore DB defaults	Restore DB variables to factory defaults Yes : Agree to restore DB defaults No : Cancel to restore DB defaults

Item	Description
Platform Key (PK)	These items allows you to enroll factory defaults or load Certificates from a file.
Key Exchange Keys	
Authorized Signatures	
Forbidden Signatures	
Authorized TimeStamps	
OsRecovery Signatures	

4.6 Boot

This Boot menu allows you to set/change system boot options



Item	Description
Full Screen LOGO Show	Enable/Disable full screen LOGO show on POST screen Enabled : Enables Full screen LOGO Show on POST screen Disabled : Disables Full screen LOGO Show on POST screen (Default setting)
Boot Option #1	Shows the information of the storage that be installed in the system Choose/set the boot priority

4.7 Save & Exit

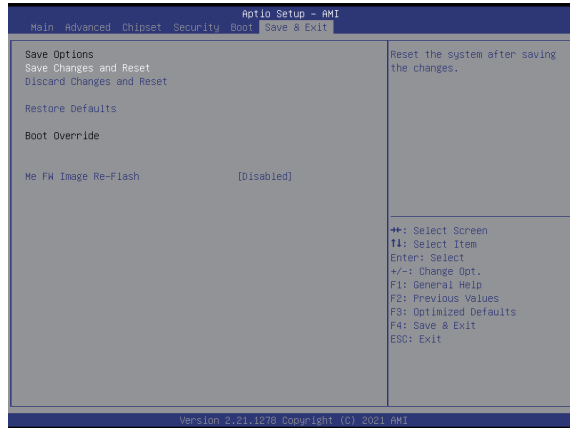

Item	Description
Save Changes and Reset	After configuring all the options that you wish to change, choose this option to save all the changes and reboot the system Yes : Agree to save and reset No : Cancel to save and reset
Discard Changes and Reset	Choose this option to reboot the system without saving any changes Yes : Agree to discard changes and reset No : Cancel to discard changes and reset
Restore Defaults	Restore/Load default values for all the setup options Yes : Agree to load optimized defaults No : Cancel to load optimized defaults
Me FW Image Re-Flash	Enable/Disable Me FW image re-flash function Enabled : Enables Me FW image re-flash function Disabled : Disables Me FW image re-flash function (Default setting)