



NEXCOM International Co., Ltd.

Network and Communication Solutions

Desktop Telecom Appliance

DTA1164W Series

User Manual

CONTENTS

Preface

Copyright	iv
Disclaimer	iv
Acknowledgements	iv
Regulatory Compliance Statements	iv
Declaration of Conformity	iv
RoHS Compliance	v
Warranty and RMA	vi
Safety Information	viii
Installation Recommendations	viii
Safety Precautions	ix
Technical Support and Assistance	x
Conventions Used in this Manual	x
Global Service Contact Information	xi
Package Contents	xiii
Ordering Information	xiv

Chapter 1: Product Introduction

Overview	1
Key Features	1
Hardware Specifications	2
Knowing Your DTA1164W	3
Front Panel	3
Rear Panel	4

Chapter 2: Jumpers and Connectors

Before You Begin	5
Precautions	5
Jumper Settings	6
Locations of the Jumpers and Connectors	7
Jumpers	8
RTC Clear	8
PMC Clear	8
ME Recover Mode	9
Connector Pin Definitions	10
External I/O Interfaces	10
12V DC Input	10
54V DC Input (For optional PoE)	10
LAN0 SFP Port	11
LAN1 SFP Port	11
Power Button	12
USB 3.0 Port	12
Internal Connectors	13
Fan Connector	13
MCU Reset	13
MCU	14
TPM	14
Mini-PCIe Connector	15
M.2 SSD Connector	16
M.2 5G/LTE Connector	17
Block Diagram	18

Chapter 3: System Setup

Removing the Chassis Cover	19
Installing a SO-DIMM Memory Module	21
Installing Both the M.2 and Wi-Fi Module	23

Chapter 4: BIOS Setup

About BIOS Setup	25
When to Configure the BIOS.....	25
Default Configuration	26
Entering Setup	26
Legends	26
BIOS Setup Utility.....	28
Main	28
Advanced	29
Intel RC Setup	38
Security	48
Boot	49
Save & Exit	50

PREFACE

Copyright

This publication, including all photographs, illustrations and software, is protected under international copyright laws, with all rights reserved. No part of this manual may be reproduced, copied, translated or transmitted in any form or by any means without the prior written consent from NEXCOM International Co., Ltd.

Disclaimer

The information in this document is subject to change without prior notice and does not represent commitment from NEXCOM International Co., Ltd. However, users may update their knowledge of any product in use by constantly checking its manual posted on our website: <http://www.nexcom.com>. NEXCOM shall not be liable for direct, indirect, special, incidental, or consequential damages arising out of the use of any product, nor for any infringements upon the rights of third parties, which may result from such use. Any implied warranties of merchantability or fitness for any particular purpose is also disclaimed.

Acknowledgements

DTA1164W and DTA1164W-A are trademarks of NEXCOM International Co., Ltd. All other product names mentioned herein are registered trademarks of their respective owners.

Regulatory Compliance Statements

This section provides the FCC compliance statement for Class B devices and describes how to keep the system CE compliant.

Declaration of Conformity

FCC

This equipment has been tested and verified to comply with the limits for a Class B digital device, pursuant to Part 15 of FCC Rules. These limits are designed to provide reasonable protection against harmful interference when the equipment is operated in a commercial environment. This equipment generates, uses, and can radiate radio frequency energy and, if not installed and used in accordance with the instructions, may cause harmful interference to radio communications. Operation of this equipment in a residential area (domestic environment) is likely to cause harmful interference, in which case the user will be required to correct the interference (take adequate measures) at their own expense.

CE

The product(s) described in this manual complies with all applicable European Union (CE) directives if it has a CE marking. For computer systems to remain CE compliant, only CE-compliant parts may be used. Maintaining CE compliance also requires proper cable and cabling techniques.

RoHS Compliance



NEXCOM RoHS Environmental Policy and Status Update

NEXCOM is a global citizen for building the digital infrastructure. We are committed to providing green products and services, which are compliant with European Union RoHS (Restriction on Use of Hazardous Substance in Electronic Equipment) directive 2011/65/EU, to be your trusted green partner and to protect our environment.

RoHS restricts the use of Lead (Pb) < 0.1% or 1,000ppm, Mercury (Hg) < 0.1% or 1,000ppm, Cadmium (Cd) < 0.01% or 100ppm, Hexavalent Chromium (Cr6+) < 0.1% or 1,000ppm, Polybrominated biphenyls (PBB) < 0.1% or 1,000ppm, and Polybrominated diphenyl Ethers (PBDE) < 0.1% or 1,000ppm.

In order to meet the RoHS compliant directives, NEXCOM has established an engineering and manufacturing task force in to implement the introduction of green products. The task force will ensure that we follow the standard NEXCOM development procedure and that all the new RoHS components and new manufacturing processes maintain the highest industry quality levels for which NEXCOM are renowned.

The model selection criteria will be based on market demand. Vendors and suppliers will ensure that all designed components will be RoHS compliant.

How to recognize NEXCOM RoHS Products?

For existing products where there are non-RoHS and RoHS versions, the suffix "(LF)" will be added to the compliant product name.

All new product models launched after January 2013 will be RoHS compliant. They will use the usual NEXCOM naming convention.

Warranty and RMA

NEXCOM Warranty Period

NEXCOM manufactures products that are new or equivalent to new in accordance with industry standard. NEXCOM warrants that products will be free from defect in material and workmanship for 2 years, beginning on the date of invoice by NEXCOM.

NEXCOM Return Merchandise Authorization (RMA)

- Customers shall enclose the “NEXCOM RMA Service Form” with the returned packages.
- Customers must collect all the information about the problems encountered and note anything abnormal or, print out any on-screen messages, and describe the problems on the “NEXCOM RMA Service Form” for the RMA number apply process.
- Customers can send back the faulty products with or without accessories (manuals, cable, etc.) and any components from the card, such as CPU and RAM. If the components were suspected as part of the problems, please note clearly which components are included. Otherwise, NEXCOM is not responsible for the devices/parts.
- Customers are responsible for the safe packaging of defective products, making sure it is durable enough to be resistant against further damage and deterioration during transportation. In case of damages occurred during transportation, the repair is treated as “Out of Warranty.”
- Any products returned by NEXCOM to other locations besides the customers’ site will bear an extra charge and will be billed to the customer.

Repair Service Charges for Out-of-Warranty Products

NEXCOM will charge for out-of-warranty products in two categories, one is basic diagnostic fee and another is component (product) fee.

System Level

- Component fee: NEXCOM will only charge for main components such as SMD chip, BGA chip, etc. Passive components will be repaired for free, ex: resistor, capacitor.
- Items will be replaced with NEXCOM products if the original one cannot be repaired. Ex: motherboard, power supply, etc.
- Replace with 3rd party products if needed.
- If RMA goods can not be repaired, NEXCOM will return it to the customer without any charge.

Board Level

- Component fee: NEXCOM will only charge for main components, such as SMD chip, BGA chip, etc. Passive components will be repaired for free, ex: resistors, capacitors.
- If RMA goods can not be repaired, NEXCOM will return it to the customer without any charge.

Warnings

Read and adhere to all warnings, cautions, and notices in this guide and the documentation supplied with the chassis, power supply, and accessory modules. If the instructions for the chassis and power supply are inconsistent with these instructions or the instructions for accessory modules, contact the supplier to find out how you can ensure that your computer meets safety and regulatory requirements.

Cautions

Electrostatic discharge (ESD) can damage system components. Do the described procedures only at an ESD workstation. If no such station is available, you can provide some ESD protection by wearing an antistatic wrist strap and attaching it to a metal part of the computer chassis.

Safety Information

Before installing and using the device, note the following precautions:

- Read all instructions carefully.
- Do not place the unit on an unstable surface, cart, or stand.
- Follow all warnings and cautions in this manual.
- When replacing parts, ensure that your service technician uses parts specified by the manufacturer.
- Avoid using the system near water, in direct sunlight, or near a heating device.
- The load of the system unit does not solely rely for support from the rackmounts located on the sides. Firm support from the bottom is highly necessary in order to provide balance stability.
- The computer is provided with a battery-powered real-time clock circuit. There is a danger of explosion if battery is incorrectly replaced. Replace only with the same or equivalent type recommended by the manufacturer. Discard used batteries according to the manufacturer's instructions.

Installation Recommendations

Ensure you have a stable, clean working environment. Dust and dirt can get into components and cause a malfunction. Use containers to keep small components separated.

Adequate lighting and proper tools can prevent you from accidentally damaging the internal components. Most of the procedures that follow require only a few simple tools, including the following:

- A Philips screwdriver
- A flat-tipped screwdriver
- A grounding strap
- An anti-static pad

Using your fingers can disconnect most of the connections. It is recommended that you do not use needle-nose pliers to disconnect connections as these can damage the soft metal or plastic parts of the connectors.

Safety Precautions

1. Read these safety instructions carefully.
2. Keep this User Manual for later reference.
3. Disconnect this equipment from any AC outlet before cleaning. Use a damp cloth. Do not use liquid or spray detergents for cleaning.
4. For plug-in equipment, the power outlet socket must be located near the equipment and must be easily accessible.
5. Keep this equipment away from humidity.
6. Put this equipment on a stable surface during installation. Dropping it or letting it fall may cause damage.
7. The openings on the enclosure are for air convection to protect the equipment from overheating. **DO NOT COVER THE OPENINGS.**
8. Make sure the voltage of the power source is correct before connecting the equipment to the power outlet.
9. Place the power cord in a way so that people will not step on it. Do not place anything on top of the power cord. Use a power cord that has been approved for use with the product and that it matches the voltage and current marked on the product's electrical range label. The voltage and current rating of the cord must be greater than the voltage and current rating marked on the product.
10. All cautions and warnings on the equipment should be noted.
11. If the equipment is not used for a long time, disconnect it from the power source to avoid damage by transient overvoltage.
12. Never pour any liquid into an opening. This may cause fire or electrical shock.
13. Never open the equipment. For safety reasons, the equipment should be opened only by skilled person.
14. If one of the following situations arises, get the equipment checked by service personnel:
 - a. The power cord or plug is damaged.
 - b. Liquid has penetrated into the equipment.
 - c. The equipment has been exposed to moisture.
 - d. The equipment does not work well, or you cannot get it to work according to the user's manual.
 - e. The equipment has been dropped and damaged.
 - f. The equipment has obvious signs of breakage.
15. Do not place heavy objects on the equipment.
16. The unit uses a three-wire ground cable which is equipped with a third pin to ground the unit and prevent electric shock. Do not defeat the purpose of this pin. If your outlet does not support this kind of plug, contact your electrician to replace your obsolete outlet.
17. **CAUTION: DANGER OF EXPLOSION IF BATTERY IS INCORRECTLY REPLACED. REPLACE ONLY WITH THE SAME OR EQUIVALENT TYPE RECOMMENDED BY THE MANUFACTURER. DISCARD USED BATTERIES ACCORDING TO THE MANUFACTURER'S INSTRUCTIONS.**

“ATTENTION: Risque d'explosion si la batterie est remplacée par un type incorrect. Mettre au rebus les batteries usagées selon les instructions.”
18. This equipment is not suitable for use in locations where children are likely to be present.

Cet équipement ne convient pas à une utilisation dans des lieux pouvant accueillir des enfants.
19. Suitable for installation in Information Technology Rooms in accordance with Article 645 of the National Electrical Code and NFPA 75.

Peut être installé dans des salles de matériel de traitement de l'information conformément à l'article 645 du National Electrical Code et à la NFPA 75.
20. Use certified and rated Laser Class I for Optical Transceiver product.

Technical Support and Assistance

1. For the most updated information of NEXCOM products, visit NEXCOM's website at www.nexcom.com.
2. For technical issues that require contacting our technical support team or sales representative, please have the following information ready before calling:
 - Product name and serial number
 - Detailed information of the peripheral devices
 - Detailed information of the installed software (operating system, version, application software, etc.)
 - A complete description of the problem
 - The exact wordings of the error messages

Warning!

1. Handling the unit: carry the unit with both hands and handle it with care.
2. Maintenance: to keep the unit clean, use only approved cleaning products or clean with a dry cloth.

Conventions Used in this Manual



Warning:

Information about certain situations, which if not observed, can cause personal injury. This will prevent injury to yourself when performing a task.



Caution:

Information to avoid damaging components or losing data.



Note:

Provides additional information to complete a task easily.

Global Service Contact Information

Headquarters

NEXCOM International Co., Ltd.

9F, No. 920, Chung-Cheng Rd.,
Zhonghe District, New Taipei City, 23586,
Taiwan, R.O.C.
Tel: +886-2-8226-7786
Fax: +886-2-8226-7782
www.nexcom.com

Asia

Taiwan

NexAIoT Headquarters

Industry 4.0 and Cloud Services

13F, No.916, Zhongzheng Rd.,
Zhonghe District, New Taipei City,
23586, Taiwan, R.O.C.
Tel: +886-2-8226-7796
Fax: +886-2-8226-7926
Email: sales@nexaiot.com
www.nexaiot.com

NexAIoT Co., Ltd.

Taichung Office

16F, No.250, Sec. 2, Chongde Rd.,
Beitun District,
Taichung City, 406, Taiwan, R.O.C.
Tel: +886-4-2249-1179
Fax: +886-4-2249-1172
Email: sales@nexaiot.com
www.nexaiot.com

NexCOBOT Taiwan Co., Ltd.

13F, No.916, Chung-Cheng Rd.,
Zhonghe District,
New Taipei City, 23586, Taiwan, R.O.C.
Tel: +886-2-8226-7786
Fax: +886-2-8226-7926
Email: sales@nexcobot.com
www.nexcobot.com

GreenBase Technology Corp.

13F, No.922, Chung-Cheng Rd.,
Zhonghe District,
New Taipei City, 23586, Taiwan, R.O.C.
Tel: +886-2-8226-7786
Fax: +886-2-8226-7900
Email: sales@nexcom.com.tw
www.nexcom.com.tw

EMBUX Technology Co., Ltd.

13F, No.916, Chung-Cheng Rd.,
Zhonghe District,
New Taipei City, 23586, Taiwan, R.O.C.
Tel: +886-2-8226-7786
Fax: +886-2-8226-7782
Email: sales@nexcom.com.tw
www.nexcom.com.tw

TMR Technology Corp.

13F, No.916, Chung-Cheng Rd.,
Zhonghe District,
New Taipei City, 23586, Taiwan, R.O.C.
Tel: +886-2-8226-7786
Fax: +886-2-8226-7782
Email: sales@nexcom.com.tw
www.nexcom.com.tw

China

NEXSEC Incorporated

5F, No.4, No.7 Fengxian Middle Rd.,
(Beike Industrial Park), Haidian District,
Beijing, 100094, China
Tel: +86-10-5704-2680
Fax: +86-10-5704-2681
Email: marketing@nexsec.cn
www.nexsec.cn

NEXCOM Shanghai

No.4, 16 Building,
Shanghai OMNI Tech & Science Park
No. 1699, Douhui Rd.,
Shanghai, 201108, China
Tel: +86-21-5278-5868
Fax: +86-21-3251-6358
Email: sales@nexcom.cn
www.nexcom.cn

NEXCOM Surveillance Technology Corp.

5F, Building C, ZhenHan Industrial Zone,
GanKeng Community, Buji Street,
LongGang District,
ShenZhen, 518112, China
Tel: +86-755-8364-7768
Fax: +86-755-8364-7738
Email: steveyang@nexcom.com.tw
www.nexcom.cn

NEXCOM United System Service

Room 603/604, Huiyinmingzun Plaza Bldg. 1,
No. 609, Yunlin East Rd.,
Shanghai, 200062, China
Tel: +86-21-5278-5868
Fax: +86-21-3251-6358
Email: renwang@nexcom.com.tw
www.nexcom.cn

NEXGOL Chongqing

1F, Building B4, Electronic 2nd Area,
(Phoenix Lake Industrial Park), Yongchuan Dist.,
Chongqing City, 402160, China
Tel: +86-23-4960-9080
Fax: +86-23-4966-5855
Email: sales@nexgol.com.cn
www.nexcobot.com/NexGOL

NexCOBOT China

Room 501, Building 1, Haichuang Building,
No.7 Qingyi Road, Guicheng Street,
Nanhai District, Foshan City,
Guangdong Province, 528314, China
Tel: +86-757-8625-7118
Email: sales@nexcobot.com
www.nexcobot.com.cn

Beijing NexGemo Technology Co.,Ltd.

5F, Gemotech Building, No.1, Development Rd.,
Changping International Information Industry Base,
Changping District,
Beijing, 102206, China
Tel: +86-10-8190-9328
Fax: +86-10-8190-9456
Email: sales@gemotech.cn
www.nexgemo.cn

Japan

NEXCOM Japan

9F, Tamachi Hara Bldg.,
4-11-5, Shiba Minato-ku,
Tokyo, 108-0014, Japan
Tel: +81-3-5419-7830
Fax: +81-3-5419-7832
Email: sales@nexcom-jp.com
www.nexcom-jp.com

America

USA NEXCOM USA

46665 Fremont Blvd.,
Fremont CA 94538, USA
Tel: +1-510-656-2248
Fax: +1-510-656-2158
Email: sales@nexcom.com
www.nexcomusa.com

NexCOBOT USA

2883 Bayview Drive,
Fremont CA 94538, USA
Tel: +1-510-362-0800
Fax: +1-510-656-2158
Email: sales@nexcobot.com
www.nexcobot.com

Europe

United Kingdom NEXCOM EUROPE

10 Vincent Avenue,
Crownhill Business Centre,
Milton Keynes, Buckinghamshire
MK8 0AB, United Kingdom
Tel: +44-1908-267121
Fax: +44-1908-262042
Email: sales.uk@nexcom.eu
www.nexcom.co.uk

Package Contents

Before continuing, verify that the DTA1164W series package that you received is complete. Your DTA1164W series package should have all the items listed in the table below.

Item	Part Number	Name	Qty
1	19TA0116408X0	DTA1164W	1
2	5044440031X00	Rubber Foot Set	4
3	6023309081X00	DB9-to-RJ45 Console Cable	1
4	7400065028X00	Power Adapter	1

Ordering Information

The following below provides ordering information for DTA1164W.

Barebone

DTA1164W (P/N: 10TA0116408X0)

Intel Denverton SoC Atom® C3436L, BGA type 4 cores 1.30 GHz

CHAPTER 1: PRODUCT INTRODUCTION

Overview



Key Features

- Intel® Denverton™ C3000 refresh series 2/4 core SoC type
- DDR4-2400 ECC memory SO-DIMM, up to 16GB
- Support M.2 SATA 2242 M-key
- 8 x 1GbE RJ45 (DTA1164W-A) or 6 x 1GbE RJ45 + 2 x SFP (DTA1164W)
- 2 ports PoE supported, 30W/port (Optional)
- Wi-Fi 5 & Wi-Fi 6 supported
- 5G/4G LTE supported

Hardware Specifications

Main Board

- DTB1164W
- Intel Atom® processor C3436L with Intel® QAT

Main Memory

- 1 x DDR4-2400 8GB SO-DIMM ECC memory (Max. 16GB)

Storage Device

- Support M.2 SATA 2242 M-key

LAN Features

- 8 x 1GbE RJ45 or 6 x 1GbE RJ45 + 2 x SFP
- Support 10/100/1000 Mbps link speed

I/O Interface-Front

- Power/SSD/SW1/SW2 & LEDs & Ethernet LED: active/link speed
- 1 x SIM slot

I/O Interface-Rear

- 2 x DC-in (12V for system, 54V for PoE optional)
- 1 x Power button
- 1 x RJ45 type console port + 1 x USB 3.0
- 1 x Reset button
- 3 x SMA connector holes for Wi-Fi 5 or Wi-Fi 6 Antenna
- 8 x 1GbE RJ45 cooper ports or 6 x 1GbE RJ45 copper ports + 2 x 1GbE SFP fiber ports
- 3 x Antenna holes for Wi-Fi 5 or Wi-Fi 6

I/O Interface-Side

- 2 x Antenna holes on each side of the chassis, total of 4 antenna holes for Sub 6G/4GLTE support

Interface-Internal

- 1 x Mini PCIe slot for Wi-Fi module (Wi-Fi 5 & Wi-Fi 6 Support)
- 1 x M.2 3042/3052 for LTE 4G/5G
- 1 x M.2 2242 storage socket

Power Input

- DC 12V/5.41A 65W power adapter for system
- DC 54V/1.33A 72W power adapter for PoE (Optional)

Dimensions

- Chassis dimension: 225 x 150 x 44 (mm)
- Carton dimension: 343 x 258 x 212 (mm)

Weight

- Without packing: 1.5kg
- With packing: 2.5kg

Environment

- Operating temperatures: 0°C-40°C
- Storage temperature: -20°C-80°C
- Relative humidity: 10%-90% non-condensing

Certifications

- CE/FCC Class B

Knowing Your DTA1164W Front Panel

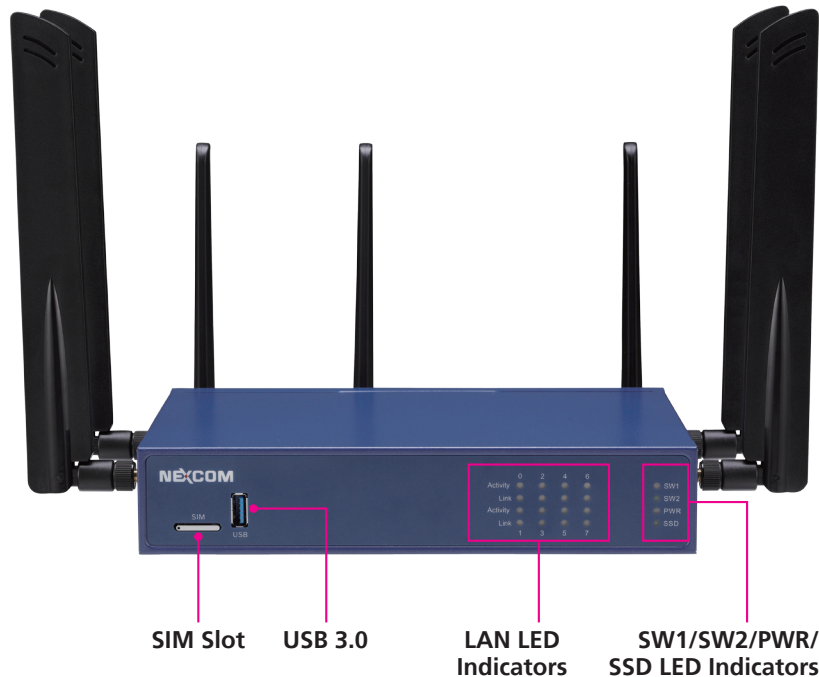

SIM Slot

Used to insert a SIM card.

USB 3.0 Port

Used to connect USB 3.0/2.0 devices.

LAN LED Indicators

Indicates the data activity and link status of LAN0 to LAN7 ports.

LED Indicators (SW1/SW2/PWR/SSD)

Two programmable LEDs (SW1 and SW2) and LEDs for power status (PWR) of the system and storage drive (SSD) activity.

Rear Panel

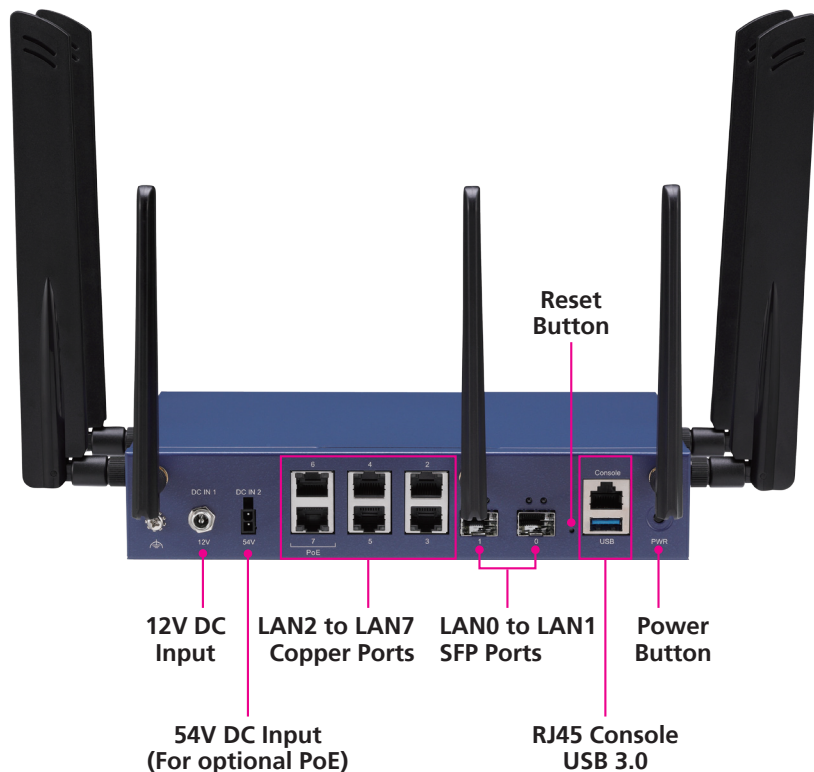

12V DC Input

Used to plug a DC power cord.

54V DC Input (For optional PoE)

Used to plug a DC power cord for optional PoE.

LAN2 to LAN7 Copper Ports

Used to connect network devices.

LAN0 to LAN1 SFP Ports

Used to connect SFP modules for connecting fiber optic network devices.

Reset Button

Press to restart the system.

RJ45 Console Port

Used to connect to devices with RJ45 type console connection.

USB 3.0 Port

Used to connect USB 3.0/2.0 devices.

Power Button

Press to power-on or power-off the system.

CHAPTER 2: JUMPERS AND CONNECTORS

This chapter describes how to set the jumpers and connectors on the DTA1164W motherboard.

Before You Begin

- Ensure you have a stable, clean working environment. Dust and dirt can get into components and cause a malfunction. Use containers to keep small components separated.
- Adequate lighting and proper tools can prevent you from accidentally damaging the internal components. Most of the procedures that follow require only a few simple tools, including the following:
 - A Philips screwdriver
 - A flat-tipped screwdriver
 - A set of jewelers screwdrivers
 - A grounding strap
 - An anti-static pad
- Using your fingers can disconnect most of the connections. It is recommended that you do not use needle-nosed pliers to disconnect connections as these can damage the soft metal or plastic parts of the connectors.
- Before working on internal components, make sure that the power is off. Ground yourself before touching any internal components, by touching a metal object. Static electricity can damage many of the electronic components. Humid environments tend to have less static electricity than

dry environments. A grounding strap is warranted whenever danger of static electricity exists.

Precautions

Computer components and electronic circuit boards can be damaged by discharges of static electricity. Working on computers that are still connected to a power supply can be extremely dangerous.

Follow the guidelines below to avoid damage to your computer or yourself:

- Always disconnect the unit from the power outlet whenever you are working inside the case.
- If possible, wear a grounded wrist strap when you are working inside the computer case. Alternatively, discharge any static electricity by touching the bare metal chassis of the unit case, or the bare metal body of any other grounded appliance.
- Hold electronic circuit boards by the edges only. Do not touch the components on the board unless it is necessary to do so. Don't flex or stress the circuit board.
- Leave all components inside the static-proof packaging that they shipped with until they are ready for installation.
- Use correct screws and do not over tighten screws.

Jumper Settings

A jumper is the simplest kind of electric switch. It consists of two metal pins and a cap. When setting the jumpers, ensure that the jumper caps are placed on the correct pins. When the jumper cap is placed on both pins, the jumper is short. If you remove the jumper cap, or place the jumper cap on just one pin, the jumper is open.

Refer to the illustrations below for examples of what the 2-pin and 3-pin jumpers look like when they are short (on) and open (off).

Two-Pin Jumpers: Open (Left) and Short (Right)

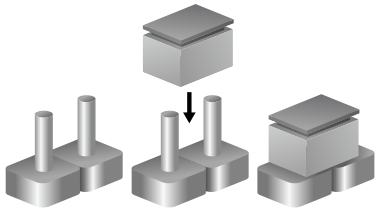

Three-Pin Jumpers: Pins 1 and 2 are Short

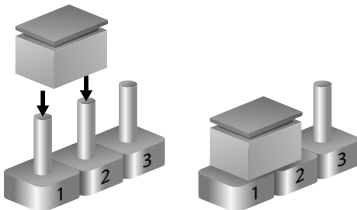

Locations of the Jumpers and Connectors

The figure below shows the location of the jumpers and connectors.

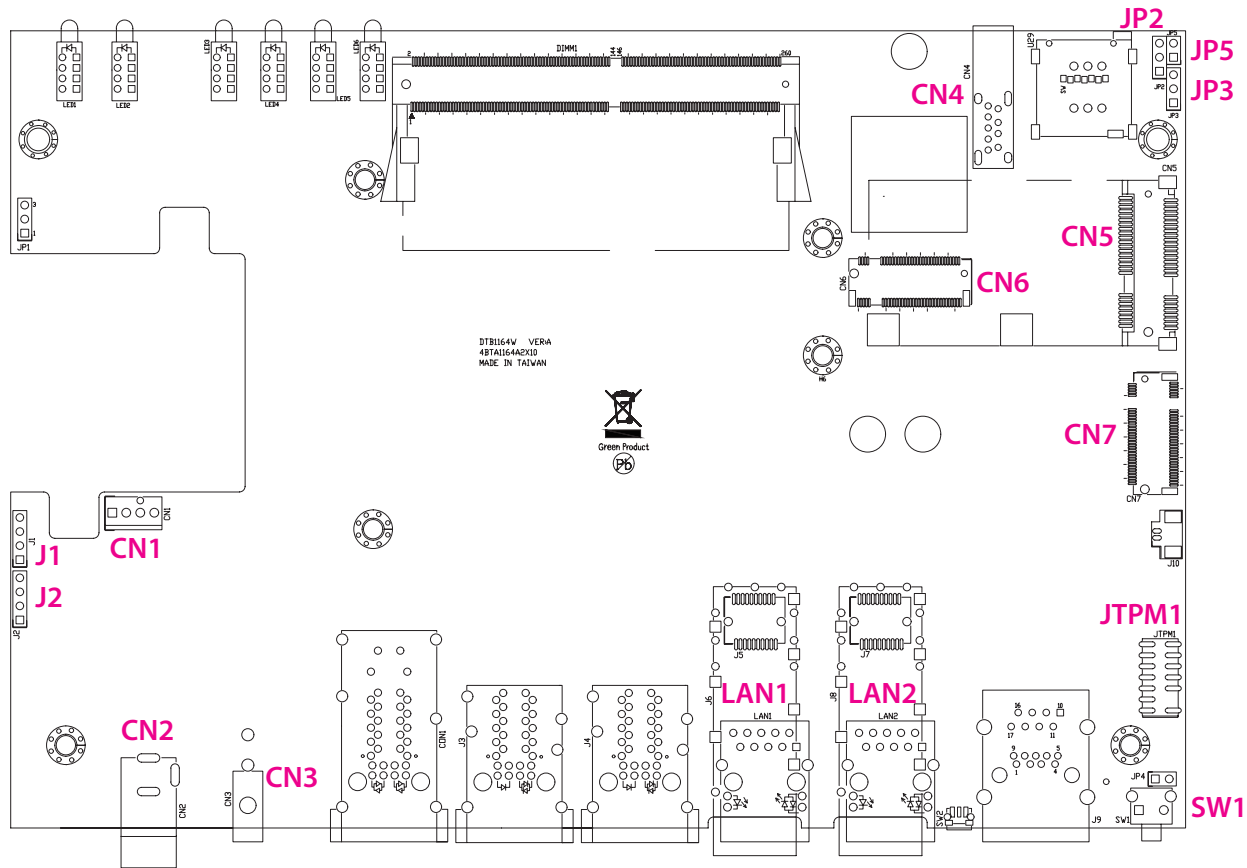

Jumpers

RTC Clear

Connector type: 1x3 3-pin header

Connector location: JP2



Pin	Function
1-2	Normal
2-3	Clear CMOS

PMC Clear

Connector type: 1x3 3-pin header

Connector location: JP3



Pin	Function
1-2	Normal
2-3	Clear PMC

ME Recover Mode

Connector type: 1x2 2-pin header

Connector location: JP5



Pin	Function
NC	Normal (Default)
1-2	ME Recover Mode

Connector Pin Definitions

External I/O Interfaces

12V DC Input

Connector location: CN2



Pin	Definition
1	GND
2	GND
3	DC_IN

54V DC Input (For optional PoE)

Connector location: CN3



Pin	Definition
1	GND
2	54V

LAN0 SFP Port

Connector type: SFP Port

Connector location: LAN2

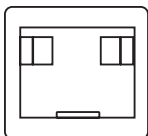

Pin	Definition	Pin	Definition
1	P_LAN2_MDI0P	2	P_LAN2_MDI0N
3	P_LAN2_MDI1P	4	P_LAN2_MDI1N
5	P_LAN2_MDI2P	6	P_LAN2_MDI2N
7	P_LAN2_MDI3P	8	P_LAN2_MDI3N
9	GND	10	GND
11	P3V3	12	PORT2_ACT_N
13	PORT2_L100_N	14	PORT2_L1000_N

LAN1 SFP Port

Connector type: SFP Port

Connector location: LAN1

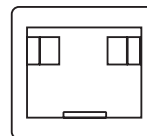

Pin	Definition	Pin	Definition
1	P_LAN1_MDI0P	2	P_LAN1_MDI0N
3	P_LAN1_MDI1P	4	P_LAN1_MDI1N
5	P_LAN1_MDI2P	6	P_LAN1_MDI2N
7	P_LAN1_MDI3P	8	P_LAN1_MDI3N
9	GND	10	GND
11	P3V3	12	PORT1_ACT_N
13	PORT1_L100_N	14	PORT1_L1000_N

Power Button

Connector location: SW1



Pin	Definition
1	GND
2	PWRBTN#_IN

USB 3.0 Port

Connector type: USB 3.0 port, Type A

Connector location: CN4

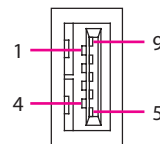

Pin	Definition	Pin	Definition
1	P5V	2	USB2_DN
3	USB2_DP	4	GND
5	USB3_RX_DN	6	USB3_RX_DP
7	GND	8	USB3_TX_DN
9	USB3_TX_DP	MH1	GND_chassis
MH2	GND_chassis	MH3	NC
MH4	NC		

Internal Connectors

Fan Connector

Connector type: 1x4 4-pin wafer

Connector location: CN1

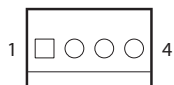

Pin	Definition	Pin	Definition
1	GND	2	P12V
3	TACH	4	PWM

MCU Reset

Connector type: 1x4 4-pin header

Connector location: J1



Pin	Definition	Pin	Definition
1	P3V_MCU	2	SWIM
3	GND	4	MCU_RESET

MCU

Connector type: 1x4 4-pin header

Connector location: J2



Pin	Definition	Pin	Definition
1	P3V_MCU	2	UART_TX
3	UART_RX	4	GND

TPM

Connector type: 2x7 14-pin header

Connector location: JTPM1

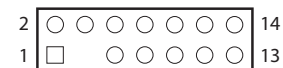

Pin	Definition	Pin	Definition
1	GND	2	LPC_CLK
3	NC	4	LPC_FRAME
5	TPM_LAD2	6	TPM_LRESET
7	TPM_LAD1	8	TPM_LAD3
9	GND	10	TPM_LAD0
11	SERIRQ_TPM	12	3.3V
13	GND	14	GND

Mini-PCIe Connector

Connector location: CN5

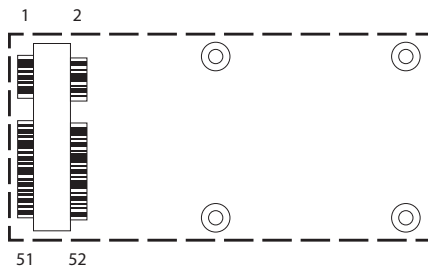

Pin	Definition	Pin	Definition
1	WAKE#	2	3.3V
3	NC	4	GND
5	NC	6	NC
7	CLKREQ#	8	NC
9	GND	10	NC
11	CLK-	12	NC
13	CLK+	14	NC
15	GND	16	NC
17	NC	18	GND
19	NC	20	W_DISABLE#
21	GND	22	PERST#
23	PCIE_RX_D-	24	3.3V
25	PCIE_RX_D+	26	GND

Pin	Definition	Pin	Definition
27	GND	28	NC
29	GND	30	SMB_CLK
31	PCIE_TX_D-	32	SMB_DATA
33	PCIE_TX_D+	34	GND
35	GND	36	USB_D-
37	GND	38	USB_D+
39	3.3V(Reserved)	40	GND
41	3.3V(Reserved)	42	LED_VWAN#
43	GND	44	LED_WLAN#
45	3.3V(Reserved)	46	LED_WPAN#
47	3.3V(Reserved)	48	NC
49	3.3V(Reserved)	50	GND
51	3.3V(Reserved)	52	3.3V

M.2 SSD Connector

Connector location: CN6



Pin	Definition	Pin	Definition
1	GND	2	3.3V
3	GND	4	3.3V
5	NC	6	NC
7	GND	8	NC
9	NC	10	NC
11	NC	12	3.3V
13	NC	14	3.3V
15	GND	16	3.3V
17	NC	18	3.3V
19	NC	20	NC
21	NC	22	NC
23	NC	24	NC
25	NC	26	NC
27	GND	28	NC
29	NC	30	NC
31	NC	32	NC
33	GND	34	NC
35	NC	36	NC
37	NC	38	DEVSLP
39	GND	40	NC

Pin	Definition	Pin	Definition
41	SATA_RX_D+	42	NC
43	SATA_RX_D-	44	NC
45	GND	46	NC
47	SATA_TX_D-	48	SATA_TX_D+
49	NC	50	PERST#
51	GND	52	CLKREQ#
53	CLK_D-	54	CLK_D+
55	NC	56	NC
57	GND	58	NC
59	NC	60	NC
61	NC	62	NC
63	NC	64	NC
65	NC	66	NC
67	NC	68	SUSCLK
69	NC	70	3.3V
71	GND	72	3.3V
73	GND	74	3.3V
75	GND		

M.2 5G/LTE Connector

Connector location: CN7



Pin	Definition	Pin	Definition
1	CONFIG3	2	3.3V
3	GND	4	3.3V
5	GND	6	Full_cut_power_off
7	USB2_D+	8	W_DISABLE#
9	USB2_D-	10	5G_LED#
11	GND	12	NC
13	NC	14	NC
15	NC	16	NC
17	NC	18	NC
19	NC	20	5G_COLAY20
21	CONGIF0	22	5G_COLAY22
23	WAN_WAKE#	24	5G_COLAY24
25	5G_DPR	26	W_DISABLE2#
27	GND	28	5G_COLAY28
29	USB3_RX-	30	SIM_RST
31	USB3_RX+	32	SIM_CLK
33	GND	34	SIM_DATA
35	USB3_TX-	36	SIM_PWR
37	USB3_TX+	38	5G_COLAY38
39	GND	40	NC

Pin	Definition	Pin	Definition
41	PCIE_RX-	42	NC
43	PCIE_RX+	44	NC
45	GND	46	NC
47	PCIE_TX-	48	NC
49	PCIE_TX+	50	PERST#
51	GND	52	CLKREQ#
53	CLK-	54	PEWAKE#
55	CLK+	56	NC
57	GND	58	NC
59	NC	60	NC
61	NC	62	NC
63	NC	64	NC
65	NC	66	SIM_DETECT
67	RESET#	68	5G_COLAY68
69	CONFIG1	70	3.3V
71	GND	72	3.3V
73	GND	74	3.3V
75	CONFIG2		

Block Diagram

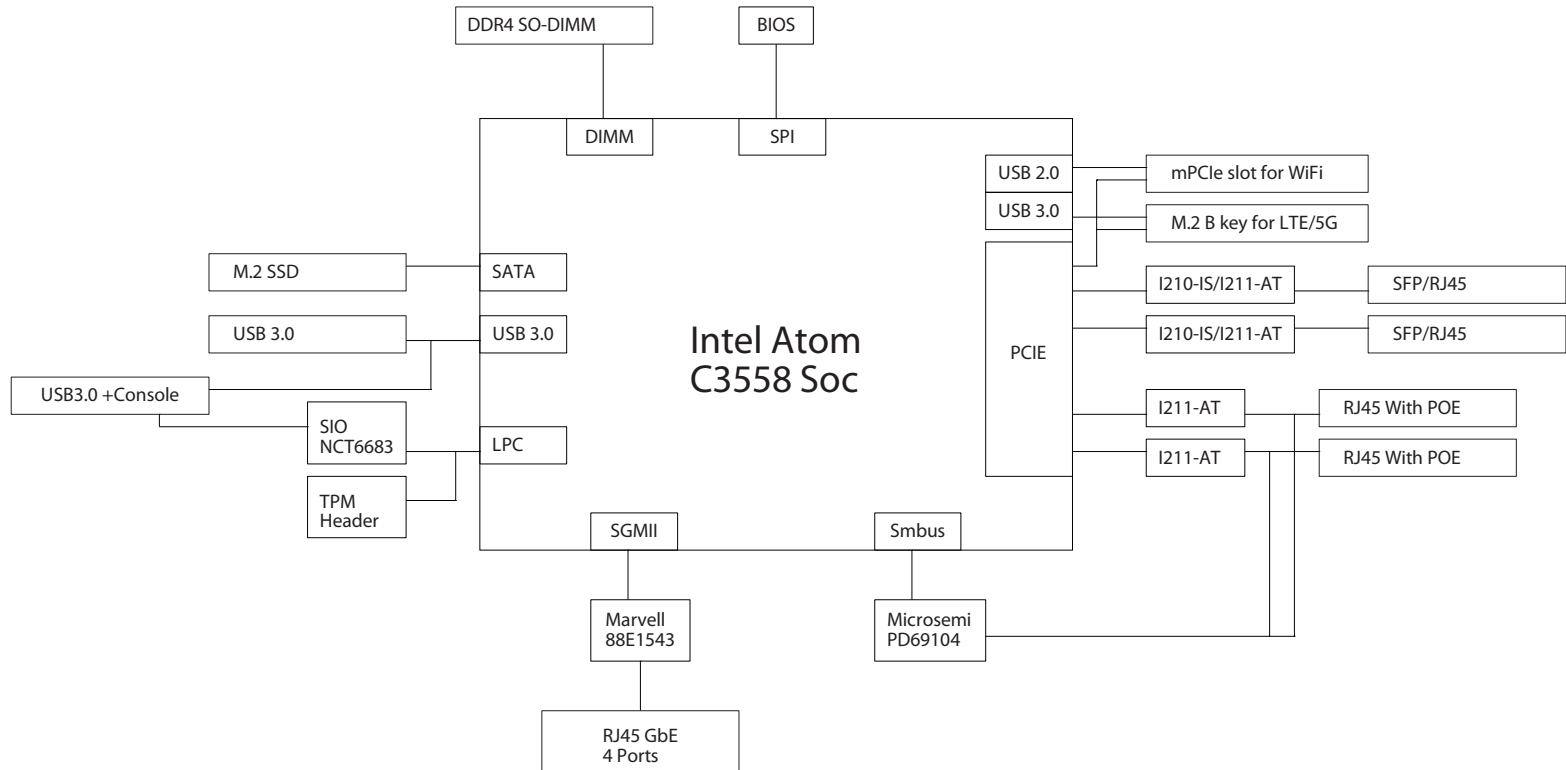

CHAPTER 3: SYSTEM SETUP

Removing the Chassis Cover



Prior to removing the chassis cover, make sure the unit's power is off and disconnected from the power sources to prevent electric shock or system damage.

1. The screws on the bottom and sides of the cover are used to secure the cover to the chassis. Remove these screws and put them in a safe place for later use.

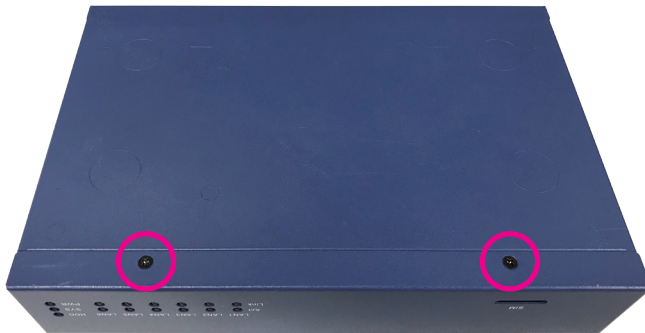

Screws on the bottom



Screws on the sides

2. With the screws removed, gently slide the cover outwards then lift up the cover to remove it.



When sliding the chassis cover back to the system, ensure that the cover does not rub against the acetate tape above the fan. The acetate tape may be damaged if installed in such way. To prevent this, place the cover past ahead of the acetate tape before sliding it back. Refer to the images below for more information.

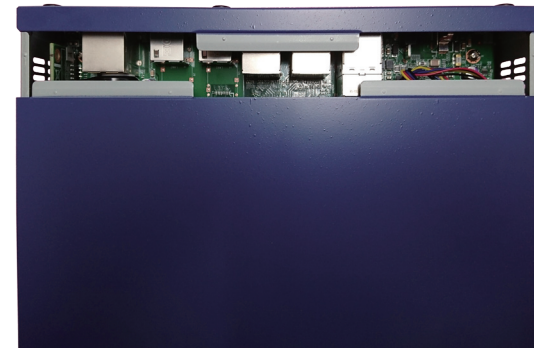

Correct way



Acetate tape

Incorrect way

Installing a SO-DIMM Memory Module

1. Loosen the 4 screws on the heatsink fan and remove it from the motherboard to access the SO-DIMM slot.
2. Locate the SO-DIMM socket on the motherboard and insert the module into the socket at an approximately 30 degrees angle. Apply firm even pressure to each end of the module until it slips into the socket. The gold-plated connector on the edge of the module will almost completely disappear inside the socket.

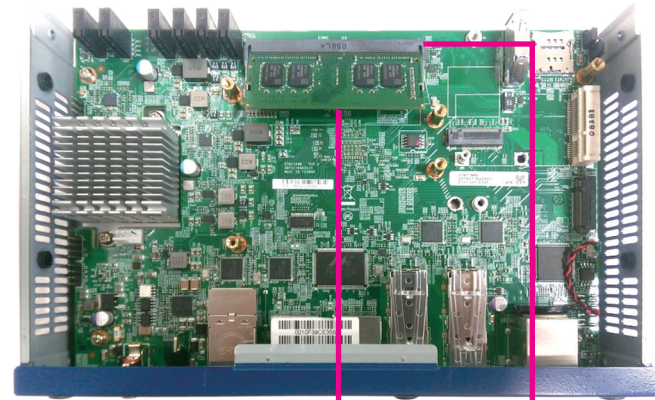
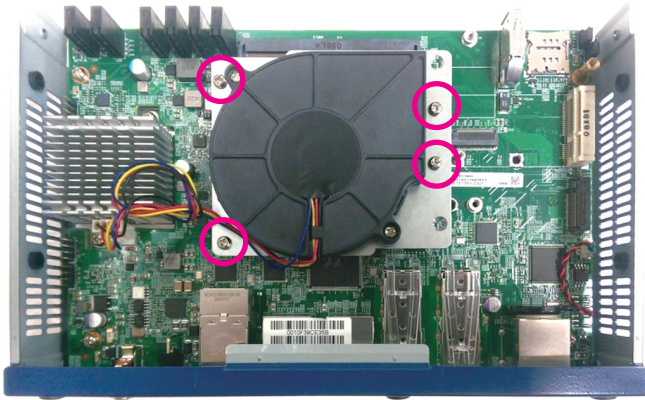

Memory Module

SO-DIMM Socket

3. Push the module down until the clips on both sides of the socket lock into position. You will hear a distinctive “click” sound, indicating the module is correctly locked into position.



Installing Both the M.2 and Wi-Fi Module



When installing both the M.2 and Wi-Fi module, please install the M.2 module first.

1. Locate the M.2 slot on the motherboard.

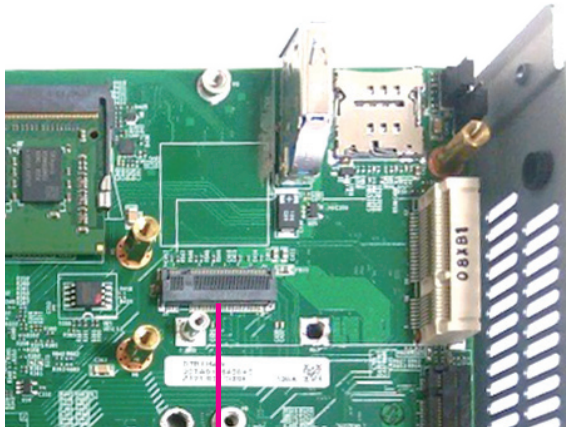

M.2 Slot

2. Insert the M.2 module into the M.2 slot at a 45 degrees angle until the gold-plated connector on the edge of the module completely disappears inside the slot. Push the M.2 module down and fasten an M.2 mounting screw into the mounting hole to secure the module.

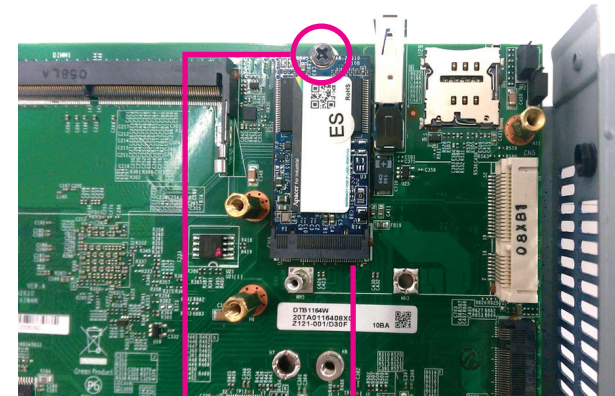

M.2 Mounting
Screw

M.2 Slot



3. Locate the Wi-Fi slot on the motherboard.

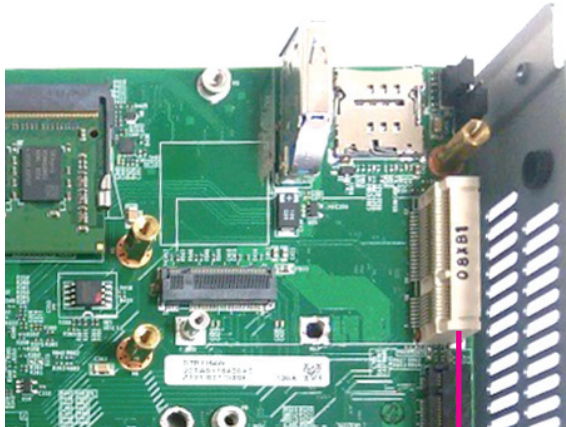

Wi-Fi Slot

4. Insert the Wi-Fi module into the Wi-Fi slot at a 45 degrees angle until the gold-plated connector on the edge of the module completely disappears inside the slot. Push the Wi-Fi module down and fasten a Wi-Fi mounting screw into the mounting hole to secure the module.

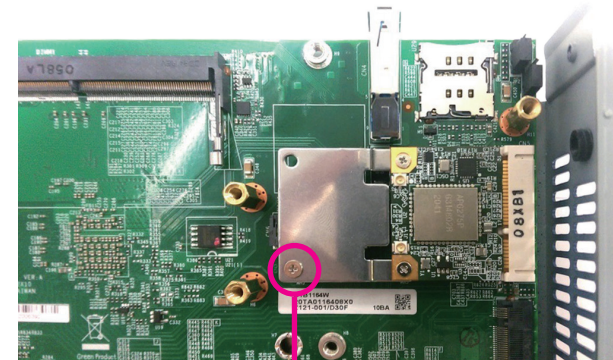

Wi-Fi Mounting Screw

CHAPTER 4: BIOS SETUP

This chapter describes how to use the BIOS setup program for the DTA1164W series. The BIOS screens provided in this chapter are for reference only and may change if the BIOS is updated in the future.

To check for the latest updates and revisions, visit the NEXCOM website at www.nexcom.com.tw.

About BIOS Setup

The BIOS (Basic Input and Output System) Setup program is a menu driven utility that enables you to make changes to the system configuration and tailor your system to suit your individual work needs. It is a ROM-based configuration utility that displays the system's configuration status and provides you with a tool to set system parameters.

These parameters are stored in non-volatile battery-backed-up CMOS RAM that saves this information even when the power is turned off. When the system is turned back on, the system is configured with the values found in CMOS.

With easy-to-use pull down menus, you can configure items such as:

- Hard drives, diskette drives, and peripherals
- Video display type and display options
- Password protection from unauthorized use
- Power management features

The settings made in the setup program affect how the computer performs. It is important, therefore, first to try to understand all the setup options, and second, to make settings appropriate for the way you use the computer.

When to Configure the BIOS

- This program should be executed under the following conditions:
 - When changing the system configuration
 - When a configuration error is detected by the system and you are prompted to make changes to the setup program
 - When resetting the system clock
 - When redefining the communication ports to prevent any conflicts
 - When making changes to the Power Management configuration
 - When changing the password or making other changes to the security setup

Normally, CMOS setup is needed when the system hardware is not consistent with the information contained in the CMOS RAM, whenever the CMOS RAM has lost power, or the system features need to be changed.

Default Configuration

Most of the configuration settings are either predefined according to the Load Optimal Defaults settings which are stored in the BIOS or are automatically detected and configured without requiring any actions. There are a few settings that you may need to change depending on your system configuration.











Entering Setup

When the system is powered on, the BIOS will enter the Power-On Self Test (POST) routines. These routines perform various diagnostic checks; if an error is encountered, the error will be reported in one of two different ways:

- If the error occurs before the display device is initialized, a series of beeps will be transmitted.
- If the error occurs after the display device is initialized, the screen will display the error message.

Powering on the computer and immediately pressing  allows you to enter Setup.

Legends

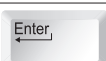
Key	Function
	Moves the highlight left or right to select a menu.
	Moves the highlight up or down between sub-menu or fields.
	Exits the BIOS Setup Utility.
	Scrolls forward through the values or options of the highlighted field.
	Scrolls backward through the values or options of the highlighted field.
	Selects a field.
	Displays General Help.
	Load previous values.
	Load optimized default values.
	Saves and exits the Setup program.
	Press <Enter> to enter the highlighted sub-menu

Scroll Bar

When a scroll bar appears to the right of the setup screen, it indicates that there are more available fields not shown on the screen. Use the up and down arrow keys to scroll through all the available fields.

Submenu

When “▶” appears on the left of a particular field, it indicates that a submenu which contains additional options are available for that field. To display the submenu, move the highlight to that field and press  .

BIOS Setup Utility

Once you enter the AMI BIOS Setup Utility, the Main Menu will appear on the screen. The main menu allows you to select from several setup functions and one exit. Use arrow keys to select among the items and press  to accept or enter the submenu.

Main

The Main menu is the first screen that you will see when you enter the BIOS Setup Utility.



Aptio Setup Utility - Copyright (C) 2021 American Megatrends, Inc.	
Main Advanced IntelRCSetup Security Boot Save & Exit	
BIOS Information	
BIOS Vendor	American Megatrends
Core Version	5.13
Compliance	UEFI 2.6; PI 1.4
Project Version	G157T 0.06 x64
Build Date and Time	03/25/2021 17:51:25
Access Level	Administrator
Memory Information	
Total Memory	8192 MB (DDR4)
System Date	[Wed 03/31/2021]
System Time	[14:36:31]
	Set the Date. Use Tab to switch between Date elements. Default Ranges: Year: 2005-2099 Months: 1-12 Days: dependent on month
	←→: Select Screen ↑↓: Select Item Enter: Select +/-: Change Opt. F1: General Help F2: Previous Values F3: Optimized Defaults F4: Save & Exit ESC: Exit
Version 2.19.1266. Copyright (C) 2021 American Megatrends, Inc.	

Access Level

Displays the access level of the current user in the BIOS.

System Date

The date format is <day>, <month>, <date>, <year>. Day displays a day, from Monday to Sunday. Month displays the month, from 1 to 12. Date displays the date, from 1 to 31. Year displays the year, from 2005 to 2099.

System Time

The time format is <hour>, <minute>, <second>. The time is based on the 24-hour military-time clock. For example, 1 p.m. is 13:00:00. Hour displays hours from 00 to 23. Minute displays minutes from 00 to 59. Second displays seconds from 00 to 59.

Advanced

The Advanced menu allows you to configure your system for basic operation. Some entries are defaults required by the system board, while others, if enabled, will improve the performance of your system or let you set some features according to your preference.



Setting incorrect field values may cause the system to malfunction.

MINI_PCIE Slot

Enables or disables the mini-PCIe slot.

WWAN radio

Enables or disables the WWAN radio.

GNSS radio

Enables or disables the GNSS radio.



Trusted Computing

This section is used to configure Trusted Platform Module (TPM) settings.



Security Device Support

Enables or disables BIOS support for security device. O.S will not show Security Device. TCG EFI protocol and INT1A interface will not be available.

NCT6683D Super IO Configuration

This section is used to configure the serial port of the super IO.



Super IO Chip

Displays the Super I/O chip used on the board.

Serial Port 1 Configuration

Configures the IO/IRQ settings of serial port 1.

Serial Port 1 Configuration

This section is used to configure serial port 1.



Serial Port

Enables or disables the serial port.

Change Settings

Selects an optimal setting for the Super IO device.

Hardware Monitor

This section is used to monitor hardware status such as temperature, fan speed and voltages.

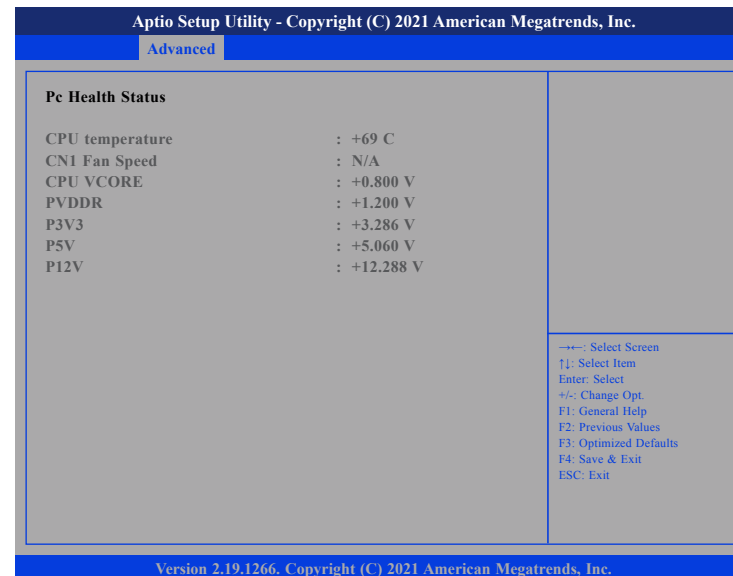

CPU temperature

Detects and displays the current CPU temperature.

CN1 Fan Speed

Detects and displays the fan speed of CN1.

CPU VCORE to P12V

Detects and displays the output voltages.

Serial Port Console Redirection

This section is used to configure the serial port that will be used for console redirection.



Console Redirection

Enables or disables the console redirection.

Console Redirection Settings

When console redirection is enabled, Console Redirection Settings will be available.

COM0 Console Redirection Settings

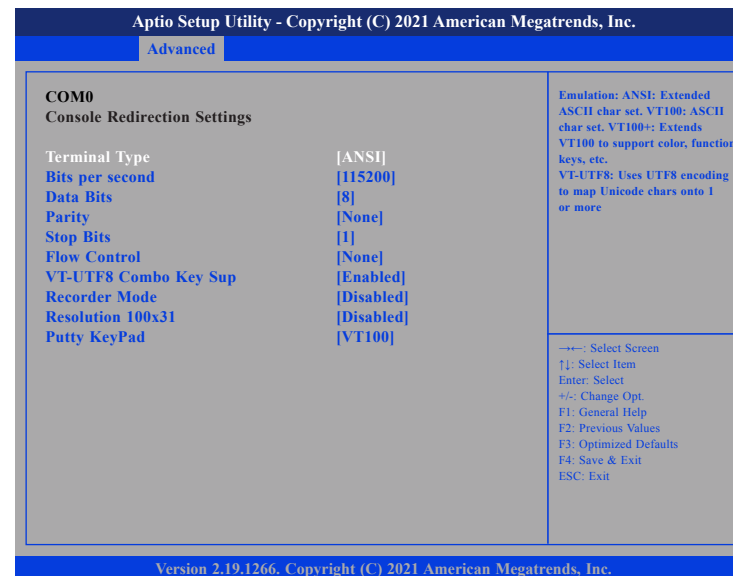

Terminal Type

ANSI Extended ASCII character set.

VT100 ASCII character set.

VT100+ Extends VT100 to support color, function keys, etc.

VT-UTF8 Uses UTF8 encoding to map Unicode characters onto 1 or more bytes.

Bits Per Second

Selects the serial port transmission speed. The speed must match the other side. Long or noisy lines may require a lower speed.

Data Bits

The options are 7 and 8.

Parity

A parity bit can be sent with the data bits to detect some transmission errors.

Even Parity bit is 0 if the number of 1's in the data bits is even.

Odd Parity bit is 0 if number of 1's in the data bits is odd.

Stop Bits

Stop bits indicate the end of a serial data packet. (A start bit indicates the beginning). The standard setting is 1 stop bit. Communication with slow devices may require more than 1 stop bit.

Flow Control

Flow control can prevent data loss from buffer overflow. When sending data and the receiving buffers are full, a "stop" signal can be sent to stop the data flow.

VT-UTF8 Combo Key Support

Enables or disables VT-UTF8 combo key support.

Recorder Mode

When this field is enabled, only text will be sent. This is to capture the terminal data.

Resolution 100x31

Enables or disables extended terminal resolution.

Putty Keypad

Selects the Putty keyboard emulation type.

PCI Subsystem Settings

This section is used to configure the PCI.



PCI Latency Timer

Configures the length of time allowed for the PCI device to control the bus before another takes over.

VGA Palette Snoop

Enables or disables the VGA palette registers snooping.

PERR# Generation

Enables or disables the PCI device to generate PERR#.

SERR# Generation

Enables or disables the PCI device to generate SERR#.

Above 4G Decoding

Enables or disables decoding of 64-bit devices in 4G address space.

SR-IOV Support

Enables or disables SR-IOV support.

BME DMA Mitigation

Enables or disables the function to re-enable bus master attribute during PCI enumeration for PCI bridges after SMM is locked.

PCI Express Settings

Aptio Setup Utility - Copyright (C) 2021 American Megatrends, Inc.

Advanced

PCI Express Device Register Settings Relaxed Ordering [Enabled] Extended Tag [Disable] No Snoop [Enabled] Maximum Payload [1024 Bytes] Maximum Read Request [256 Bytes]		Enables or Disables PCI Express Device Relaxed Ordering.
PCI Express Link Register Settings ASPM Support [Disable] WARNING: Enabling ASPM may cause some PCI-E devices to fail Extended Synch [Disable]		
Link Training Retry [5] Link Training Timeout 1000 Unpopulated Links [Keep Link ON]		←→: Select Screen ↑↓: Select Item Enter: Select +/-: Change Opt. F1: General Help F2: Previous Values F3: Optimized Defaults F4: Save & Exit ESC: Exit

Version 2.19.1266. Copyright (C) 2021 American Megatrends, Inc.

Relaxed Ordering

Enables or disables the PCI Express device's relaxed ordering.

Extended Tag

When this function is enabled, it allows a device to use 8-bit tag field as a request.

No Snoop

Enables or disables the PCI Express device's no snoop option.

Maximum Payload

Selects the maximum TLP payload size of the PCI Express devices.

Maximum Read Request

Selects the maximum read request size of the PCI Express devices.

ASPM Support

Selects the ASPM level.

Force L0 Forces all links to L0 state.

Auto The BIOS automatically selects an ASPM level.

Disable Disables ASPM.

Extended Synch

When this function is enabled, it allows generation of extended synchronization patterns.

Link Training Retry

Selects the number of retry attempts.

Link Training Timeout

Selects the timeout period of link training in microseconds.

Unpopulated Links

Enables or disables unpopulated PCI Express links.

PCI Express GEN 2 Settings



Completion Timeout

Configures the completion timeout value.

Target Link Speed

Configures the PCIe link speed.

Network Stack Configuration

This section is used to configure the network stack.

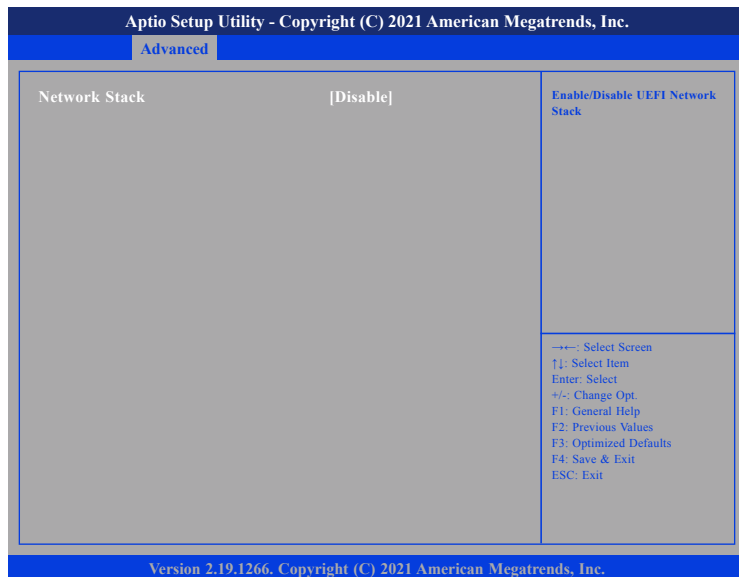

Network Stack

Enables or disables UEFI network stack.

CSM Configuration

This section is used to configure the compatibility support module features.

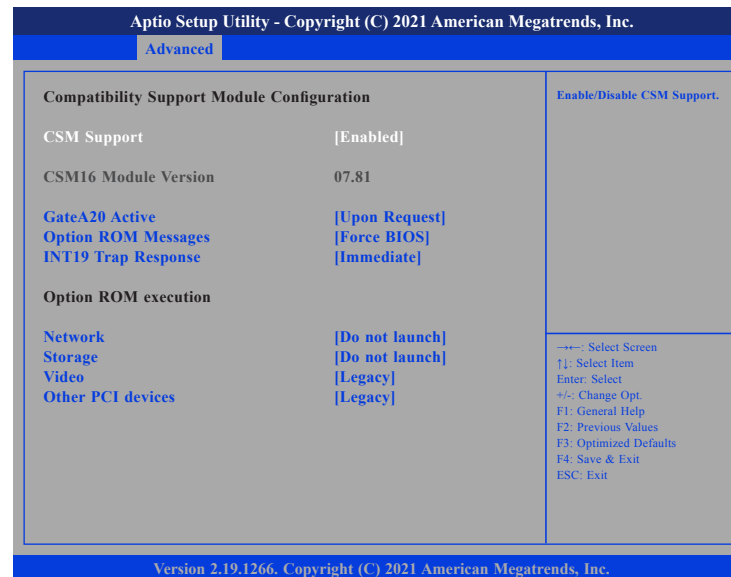

CSM Support

This field is used to enable or disable CSM support, if Auto option is selected, based on OS, CSM will be enabled or disabled automatically.

GateA20 Active

Upon Request GA20 can be disabled using BIOS services.
 Always Do not allow disabling of GA20; this option is useful when any RT code is executed above 1MB.

Option ROM Messages

This field is used to set display mode for Option ROM. The options are Force BIOS and Keep Current.

INT19 Trap Response

Allows Option ROMs to trap Interrupt 19 when enabled.

Immediate	Execute the trap right away.
Postponed	Execute the trap during legacy boot.

Network

Enables or disables the boot option for legacy network devices.

Storage

Enables or disables the boot option for legacy storage devices.

Video

Enables or disables the boot option for legacy video devices.

Other PCI Devices

Enables or disables the boot option for legacy PCI devices.

USB Configuration

This section is used to configure the USB.



Legacy USB Support

Enable	Enables Legacy USB.
Auto	Disables support for Legacy when no USB devices are connected.
Disable	Keeps USB devices available only for EFI applications.

XHCI Hand-off

This is a workaround for OSeS that does not support XHCI hand-off. The XHCI ownership change should be claimed by the XHCI driver.

USB Mass Storage Driver Support

Enables or disables USB mass storage driver support.

Port 60/64 Emulation

Enables the 60h/64h I/O port emulation. You must enable this to fully support USB keyboard legacy for non-USB OSes.

Mass Storage Devices:

Selects the mass storage device emulation type.

Intel RC Setup

This section is used to configure the processor and chipset settings.

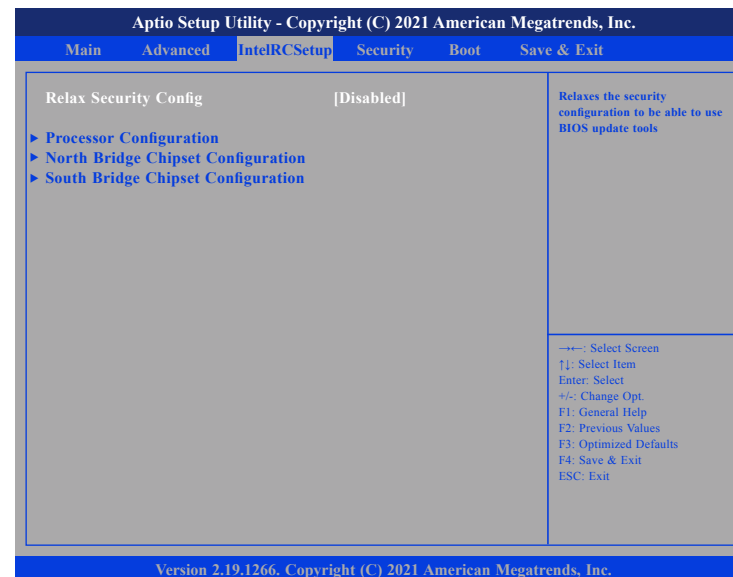

Relax Security Config

Enables or disables the security configuration to be able to use BIOS update tools.

Processor Configuration

Aptio Setup Utility - Copyright (C) 2021 American Megatrends, Inc.

IntelRCSetup

Processor Configuration		Enable/Disable EIST. GV3 and TM1 must be enabled for TM2 to be available. GV3 must be enabled for Turbo. Auto - Enable for B0 CPU stepping, all others disabled, change setting to override.
Processor ID	000506F1	
Processor Frequency	1.500GHz	
CPU BCLK Frequency	100MHz	
L1 Cache RAM	56KB	
L2 Cache RAM	2048KB	
Processor Version		
Intel(R) Atom(TM) CPU C3338 @ 1.50GHz		
EIST (GV3)	[Disable]	
Turbo	[Disable]	
Max CPUID Value Limit	[Disable]	
Execute Disable Bit	[Enable]	
VMX	[Enable]	
Extended APIC	[Enable]	
AES-NI	[Enable]	

Version 2.19.1266. Copyright (C) 2021 American Megatrends, Inc.

←→: Select Screen
↑↓: Select Item
Enter: Select
+/-: Change Opt.
F1: General Help
F2: Previous Values
F3: Optimized Defaults
F4: Save & Exit
ESC: Exit

EIST (GV3)

Enables or disables Intel® SpeedStep. GV3 and TM1 must be enabled for TM2 to be available. GV3 must be enabled for Turbo.

Auto - Enable for B0 CPU stepping, all others will be disabled, change setting to override.

Max CPUID Value Limit

Set this field to Disable when using Windows XP. Set this field to Enable when using legacy operating systems so that the system will boot even when it doesn't support CPUs with extended CPUID function.

Execute Disable Bit

When this field is set to Disable, it will force the XD feature flag to always return to 0.

VMX

When this field is set to Enabled, the VMM can utilize the additional hardware capabilities provided by Vanderpool Technology.

Extended APIC

Enables or disables extended APIC support.

AES-NI

Enables or disables Intel® AES-NI support.

North Bridge Chipset Configuration

The screenshot shows the 'North Bridge Chipset Configuration' screen in the Aptio Setup Utility. The title bar reads 'Aptio Setup Utility - Copyright (C) 2021 American Megatrends, Inc.' and the menu bar shows 'IntelRCSetup'. The main content area is divided into two columns. The left column is titled 'North Bridge Chipset Configuration' and contains a section for 'Memory Information' with the following details: Total Memory (8192 MB), Memory Frequency (DDR4 - 1866 MHz), and Memory Frequency (DDR-2400). Below this is a blue arrow pointing to 'SSA Config'. The right column contains 'DDR memory frequency: DDR4 up to DDR-2666' and 'DDR3 up to DDR-1867'. At the bottom right, a legend lists navigation keys: ←→: Select Screen, ↑↓: Select Item, Enter: Select, +/-: Change Opt., F1: General Help, F2: Previous Values, F3: Optimized Defaults, F4: Save & Exit, and ESC: Exit. The footer indicates 'Version 2.19.1266. Copyright (C) 2021 American Megatrends, Inc.'

Memory Frequency

Configures the DDR memory frequency.

SSA Config

The screenshot shows the 'SSA Config' screen in the Aptio Setup Utility. The title bar reads 'Aptio Setup Utility - Copyright (C) 2021 American Megatrends, Inc.' and the menu bar shows 'IntelRCSetup'. The main content area is divided into two columns. The left column is titled 'SSA Config' and shows 'VT-d' set to '[Disabled]'. The right column is titled 'Option to Enable / Disable VT-d'. At the bottom right, a legend lists navigation keys: ←→: Select Screen, ↑↓: Select Item, Enter: Select, +/-: Change Opt., F1: General Help, F2: Previous Values, F3: Optimized Defaults, F4: Save & Exit, and ESC: Exit. The footer indicates 'Version 2.19.1266. Copyright (C) 2021 American Megatrends, Inc.'

VT-d

Enables or disables Intel® VT-d technology.

South Bridge Chipset Configuration



State After G3

Configures which state to use when power is re-applied after a power failure (G3 state).

SATA Configuration

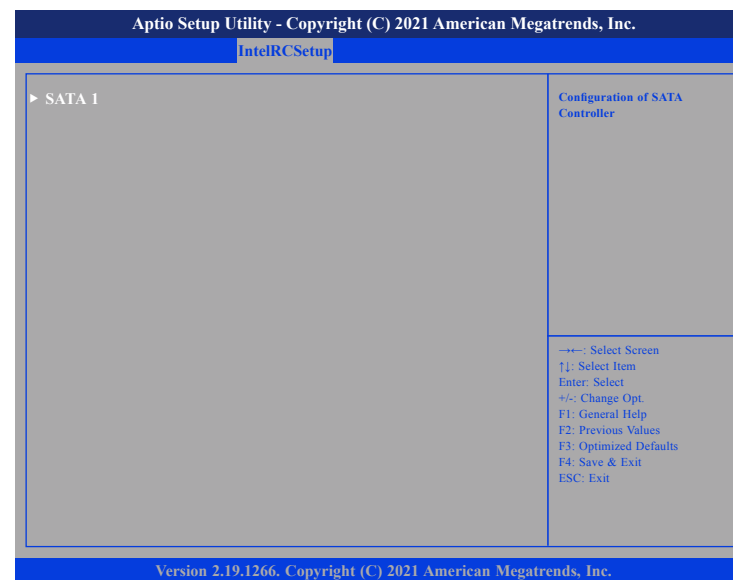

SATA 1

Enters the sub-menu of SATA 1 configuration.

SATA 1



Enable controller

Enables or disables the SATA controller if supported by the current CPU SKU.

Speed limit

Configures the speed limit of the SATA controller.

Port 0

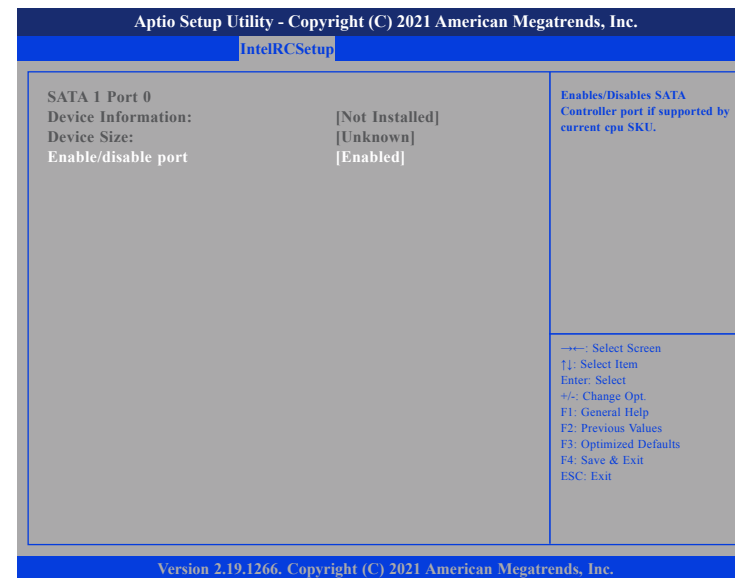

Enable/disable port

Enables or disables the SATA controller port if supported by the current CPU SKU.

USB Configuration



USB SS Configuration

Enters the sub-menu for USB super speed configuration.

USB HS Configuration

Enters the sub-menu for USB high speed configuration.

USB SS Configuration

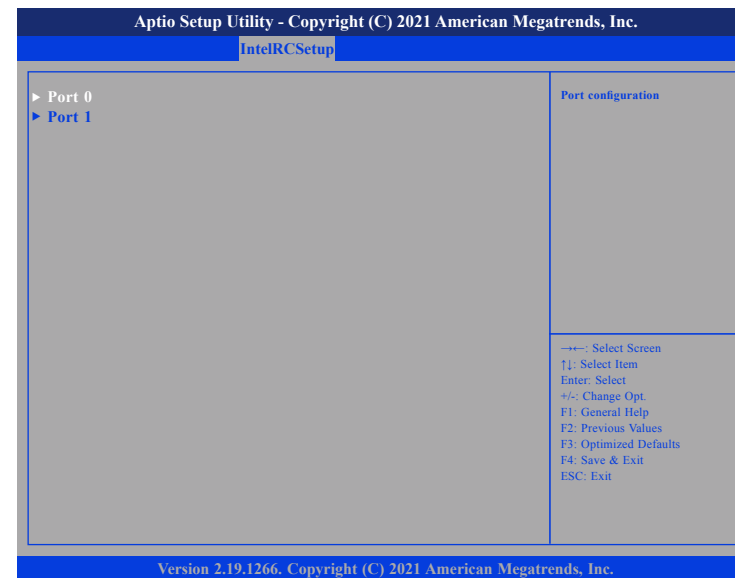

Port 0 and Port 1

Enters the sub-menu for port 0 and port 1 configuration.

USB SS Port 0

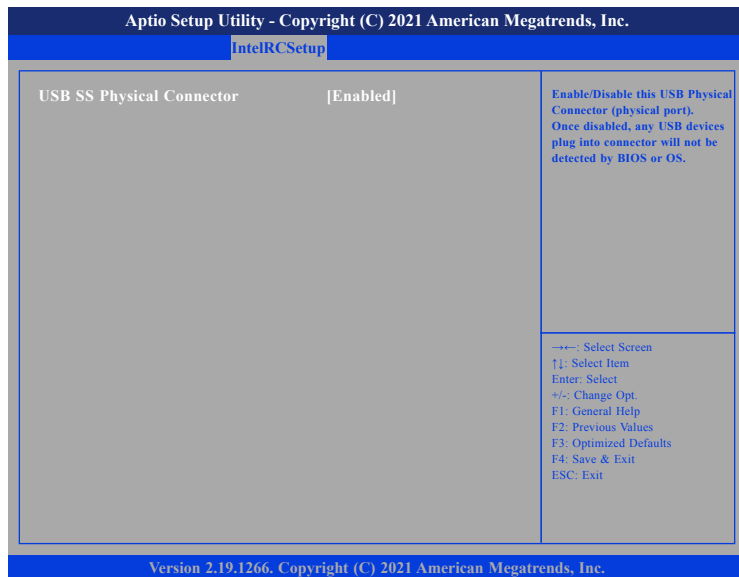

USB SS Physical Connector

Enables or disables the USB Physical Connector (physical port). Once disabled, any USB devices plugged into the connector will not be detected by BIOS or OS.

USB SS Port 1

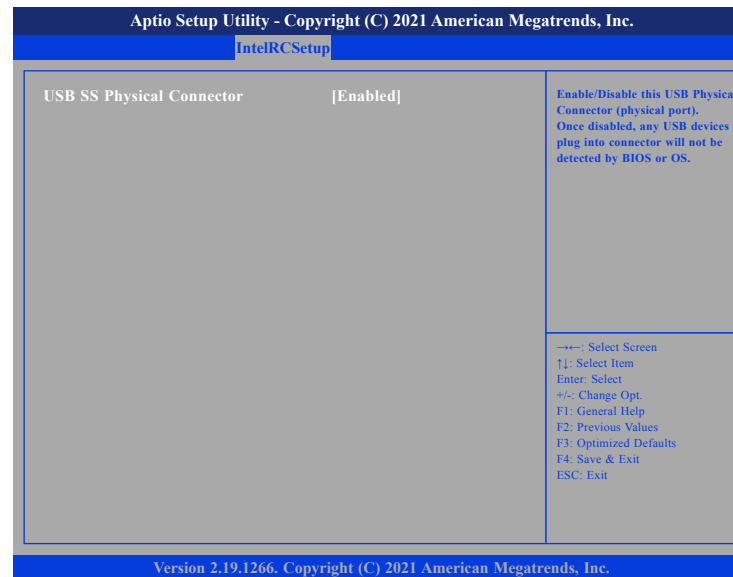

USB SS Physical Connector

Enables or disables the USB Physical Connector (physical port). Once disabled, any USB devices plugged into the connector will not be detected by BIOS or OS.

USB HS Configuration



Port 0 to Port 3

Enters the sub-menu for port 0 to port 3 configuration.

USB HS Port 0



USB HS Physical Connector

Enables or disables the USB Physical Connector (physical port). Once disabled, any USB devices plugged into the connector will not be detected by BIOS or OS.

USB HS Port 1

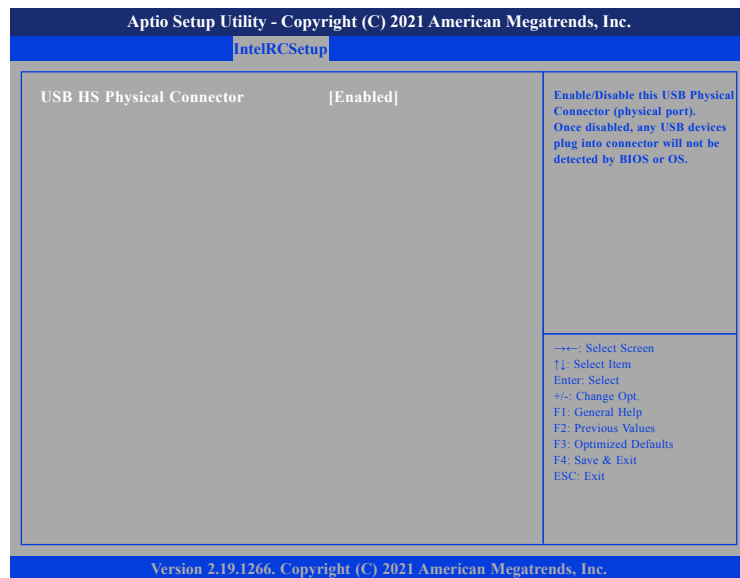

USB HS Physical Connector

Enables or disables the USB Physical Connector (physical port). Once disabled, any USB devices plugged into the connector will not be detected by BIOS or OS.

USB HS Port 2



USB HS Physical Connector

Enables or disables the USB Physical Connector (physical port). Once disabled, any USB devices plugged into the connector will not be detected by BIOS or OS.

USB HS Port 3

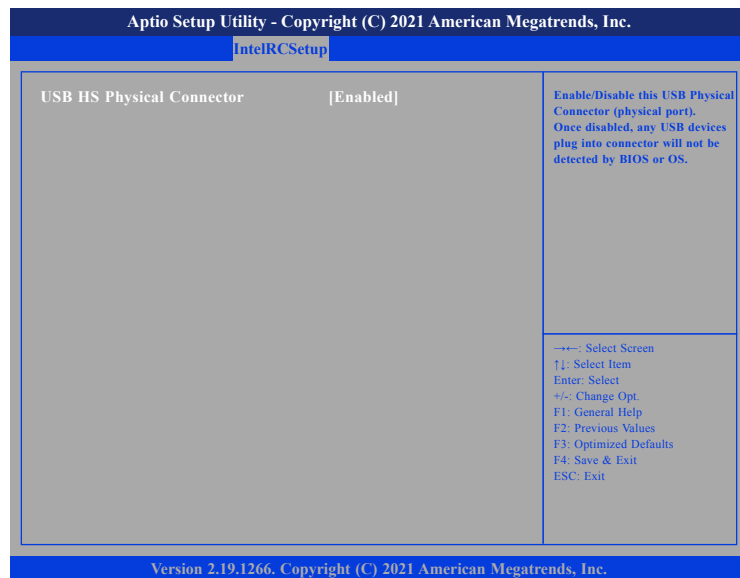

USB HS Physical Connector

Enables or disables the USB Physical Connector (physical port). Once disabled, any USB devices plugged into the connector will not be detected by BIOS or OS.

IQAT Configuration

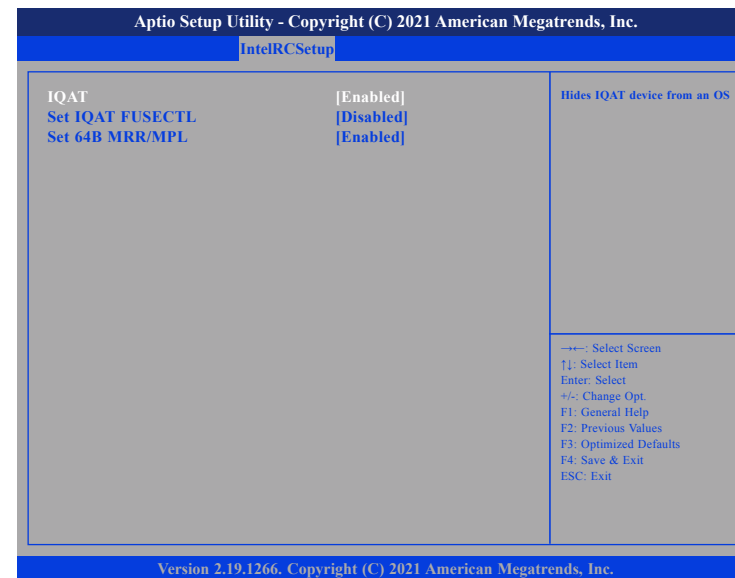

IQAT

Enables or disables hiding of IQAT device from an OS.

Set IQAT FUSECTL

Enables or disables the configuration of IQAT FUSECTL register.

Set 64B MRR/MPL

Enables or disables the configuration of 64B MRR/MPL in IQAT DevCTL register.

Security

Aptio Setup Utility - Copyright (C) 2021 American Megatrends, Inc.					
Main	Advanced	IntelRCSetup	Security	Boot	Save & Exit
Password Description If ONLY the Administrator's password is set, then this only limits access to Setup and is only asked for when entering Setup. The password length must be in the following range: Minimum length 3 Maximum length 20 Administrator Password		Set Administrator Password			
		→←: Select Screen ↑↓: Select Item Enter: Select +/-: Change Opt. F1: General Help F2: Previous Values F3: Optimized Defaults F4: Save & Exit ESC: Exit			
Version 2.19.1266. Copyright (C) 2021 American Megatrends, Inc.					

Administrator Password

Select this to reconfigure the administrator's password.

Boot



Setup Prompt Timeout

Selects the number of seconds to wait for the setup activation key. 65535(0xFFFF) denotes indefinite waiting.

Bootup NumLock State

This allows you to determine the default state of the numeric keypad. By default, the system boots up with NumLock on wherein the function of the numeric keypad is the number keys. When set to Off, the function of the numeric keypad is the arrow keys.

Boot mode select

Configures the boot mode option.

Boot Option #1 to Boot Option #8

Adjust the boot sequence of the system. Boot Option #1 is the first boot device that the system will boot from, next will be Boot Option #2 and so forth.

Save & Exit



Save Changes and Reset

To save the changes and reset, select this field then press <Enter>. A dialog box will appear. Confirm by selecting Yes.

Discard Changes and Reset

To exit the Setup utility and reset without saving the changes, select this field then press <Enter>. You may be prompted to confirm again before exiting.

Restore Defaults

To restore the BIOS to default settings, select this field then press <Enter>. A dialog box will appear. Confirm by selecting Yes.

Boot Override

To bypass the boot sequence from the Boot Option List and boot from a particular device, select the desired device and press <Enter>.

Launch EFI Shell from filesystem device

To launch EFI shell from a filesystem device, select this field and press <Enter>.